

# The Engineer's Tool Kit

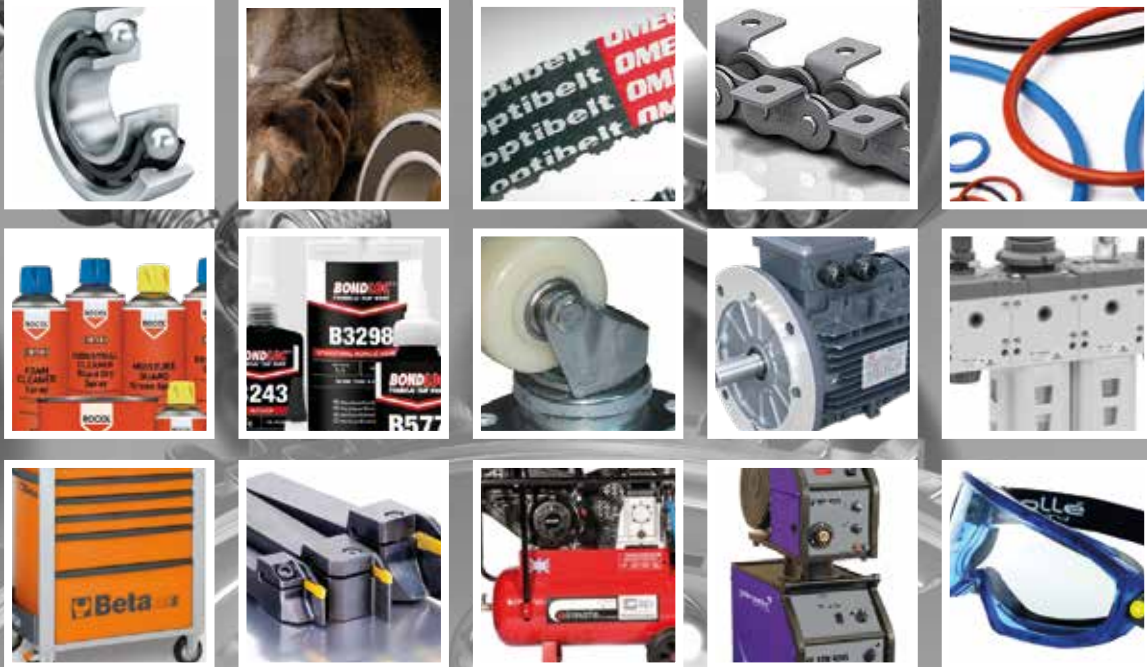

TRADING AS ASHLEY POWER LTD

# The Engineer's ToolKit CONTENTS

BEARINGS

BELT DRIVES

POWER TRANSMISSIONS

SEALS

ADHESIVES & SEALANTS

LUB & MAIN

CASTORS

MOTOR PUMP & GEARBOX

FLUID POWER

TOOLS

CUTTING TOOLS & ABRASIVES

MAINTENANCE & CONDITION MONITORING

WELDING

WORKWEAR & PPE



We pioneer motion

## The best parts build the best machines

**FAG Gen-C One Schaeffler Design standardised for OD 26mm to 90mm. Whatever your plans, our deep groove ball bearings always give you that all-important advantage.**

- Longer life
- Less noise
- Lower friction
- Choice of cage material
- Variety of sealing configurations
- Multiple radial clearance options
- Current-insulated designs
- Unmatched performance versus cost

[www.schaeffler.co.uk](http://www.schaeffler.co.uk)



**FAG**

**SCHAEFFLER**



We pioneer motion

## Angular contact ball bearings multiple designs

**Particularly suitable for combined loads.  
They are also available in X-Life quality.**

### Single row series 7200 & 7300

- Universal designs for mounting in bearing sets

Available cages:

- Polyamide (standard design) suffix TVP
- Sheet steel (suffix JP)
- Machined brass (suffix MP)
- Open and sealed versions (suffix 2RS)

### Double row series 3200 & 3300

- Correspond to single row ACBB's in pairs in an O arrangement but give a narrower design
- Solid inner & outer rings
- Polyamide (standard design) suffix TVP
- Sheet steel (suffix JP)
- Machined brass (suffix MP)
- Open and sealed versions (suffix 2RS)

**FAG**



**SCHAEFFLER**

[www.schaeffler.co.uk](http://www.schaeffler.co.uk)



We pioneer motion

## Axial deep groove ball bearings

**Series 51000 to 54000; single and double direction**  
Standardised, ready-to-fit with high axial load carrying capacity.

- Comprise shaft locating washer and housing locating washer; ball and cage assembly
- Can be mounted separately from each other
- Bearings are of a multi piece construction and due to their design are not self-retaining
- Available in single and double direction designs

[www.schaeffler.co.uk](http://www.schaeffler.co.uk)



**FAG**

**SCHAEFFLER**



We pioneer motion

## Radial insert ball bearings and housed units

**FAG's Black Series radial insert ball bearings and housing units are easy to mount, smooth running and offer high reliability.**

### FAG Black Series | Features

- Japanese industry standard JIS B 1559 dimensions
- Durotect® B coating on inner and outer rings and flinger shields
- Cast iron housing
- Metric or inch size dimensions
- Radial insert ball bearings based on series 62.. deep groove ball bearings
- Location by means of grub screws in inner ring or tapered adaptor sleeve
- Housing tolerances J7 and H7

[www.schaeffler.co.uk](http://www.schaeffler.co.uk)



**SCHAEFFLER**

## Radial insert ball bearings

FAG radial insert ball bearings with a spherical outer ring are based on single row deep groove ball bearings 62 and are designed in accordance with JIS B 1558. The outer and inner rings as well as the flinger shields of the radial insert ball bearings are provided with the Durotect BS coating in order to offer basic protection against corrosion. The Black Series radial insert ball bearings are available with two location methods. They can be relubricated and are particularly easy to install.

## Housing units with flake graphite cast iron housings

Housing units in accordance with JIS B 1557 comprise FAG flake graphite cast iron housings with a concave bore in which FAG radial insert ball bearings are fitted. These units are available as plummer block housing units, flanged housing units and take-up housing units.

Radial insert ball bearings with a spherical outer ring, when fitted in housings with a concave bore, can compensate for static misalignment of the shaft.

Housing units are supplied with a loose packed lubrication nipple and integrated end cap for the lubrication nipple as well as an Allen key.

## SCHAEFFLER



FAG



FAG









**SCHAEFFLER**

We pioneer motion

# FAG Black Series range

Manufacturer									
	<b>FAG</b>	<b>UC2</b>	<b>UCP2</b>	<b>UCPA2</b>	<b>UCFC</b>	<b>UCF</b>	<b>UCFA</b>	<b>UCFL</b>	<b>UCT</b>
<b>FAG UC Radial Insert Ball Bearings</b> with set screws in inner ring. Bore Diameter: 12mm to 90mm, 1/2" to 3-1/2"	SKF	YAR2...2F	SYJ...TF	SYFJ...TF	FYC...TF	FYJ...TF	-	FYTJ...TF	TUJ...TF
	NTN	UC2...D1	UCP...D1	UCUP...D1	UCFC...D1	UCF...D1	UCFA-D1	UCFL...D1	UCT...D1
	SNR	UC2...G2	UCP	UCPA	UCFC	UCF	UCFA	UCFL	UCT
	NSK	UC2	UCP	UCPA	UCFC	UCF	UCFA	UCFL	UCT
	KOYO	UC2	UCP	UCPA	UCFC	UCF	UCFA...J	UCFL	UCT...J
	ASAHI	UC2	UCP	UCPA	UCFC	UCF	UCFA	UCFL	UCT

Manufacturer							
	<b>FAG</b>	<b>UK2</b>	<b>UKP</b>	<b>UKFC</b>	<b>UKF</b>	<b>UKFL</b>	<b>UKT</b>
<b>FAG UK Radial Insert Ball Bearings</b> with adapter sleeve. Bore Diameter: 20mm to 80mm	SKF	YSA2...2FK, H23	SYJ...KF	FYC...KF	FYJ...KF	FYTJ...KF	TUJ...FK
	NTN	UK2...D1, H23...K	UKP...D1, H23...X	UKFC...D1, H23...X	UKF...D1, H23...X	UKFL...D1, H23...X	UKT...D1, H23...X
	SNR	UK2...G2H	UKP...H	UKFC...H	UKF...H	UKFL...H	UKT...H
	NSK	UK2...+H23	UKP...+H23	UKFC...+H23	UKF...H23	UKFL...+H23	UKT...+H23
	KOYO	UK2...+H23	UKP	UKFC	UKF	UKFL	UKT
	ASAHI	UK2...+H23	UKP...+H23	UKFC...+H	UKF...H23	UKFL...+H	UKT...+H

[www.schaeffler.co.uk](http://www.schaeffler.co.uk)





We pioneer motion

## Spherical roller bearings

Spherical roller bearings from FAG for all your application needs from 20mm to 1220mm  
In every design you will benefit from

- Longer operating life
- High static & load carrying capacities
- Improved roller quality
- Reduced friction

- Lower operating temperatures
- Optimal lubrication
- Downsizing is possible
- Cylindrical and tapered bore options

[www.schaeffler.co.uk](http://www.schaeffler.co.uk)

**FAG**



**SCHAEFFLER**



We pioneer motion

## Cylindrical roller bearings

**Cylindrical roller bearings from FAG**  
Available in various designs and optimised for different applications depending on the structure of the bearing.

**Available with plastic, brass or steel cages.**

- Cylindrical roller bearings are available as non-locating, semi-locating and locating bearing designs

- Special bearings are made for traction motor and wind turbine applications along with many other specialist applications

[www.schaeffler.co.uk](http://www.schaeffler.co.uk)



**SCHAEFFLER**



We pioneer motion

## Tapered roller bearings

Tapered roller bearings from 15 - 360mm in standard design are reliable, energy efficient and designed for high radial and axial loads with a broad range of speeds.

- Single row, matched or integral (JKO range) design
- Seperable, which simplifies fitting and mounting
- X-life quality available
- Long operating life
- Low friction, smooth running
- Operating temperatures of 200°C for OD's of 220mm and above

[www.schaeffler.co.uk](http://www.schaeffler.co.uk)



**FAG**



**SCHAEFFLER**



We pioneer motion

## SNV split plummer block housings

Quick to mount, easy to lubricate. For shaft diameters 20mm to 160mm and  $\frac{3}{4}$  inches and  $5\frac{1}{5}$  inches

- Grease outlet hole
- Simplified relubrication
- Minimal fitting work
- Supportive of very high loads
- Optimised for fitting condition monitoring

- and relubrication systems
- Additional protection with double lip seals, labyrinth seals, felt seals, V ring seals, combined or special seals

[www.schaeffler.co.uk](http://www.schaeffler.co.uk)



**FAG**

**SCHAEFFLER**

## SCHAEFFLER

We pioneer motion

# medias

## Product catalogue and consulting platform



### Easy quoting & ordering process

- Get your current product price and availability
- Overview of current and historical orders as well as sales contracts



### Central platform for all information on Industrial products & solutions

- Technical & product information
- Premium content (Whitepapers, online trainings, ...)



### Technical consulting and support

- Engineering tools
- Extended product information such as CAD models and calculation tools



### Sales Partner Finder

Receive a request for an offer from a **medias Plus** user by email. Add the products with one click to your **medias Business** account



#### The perfect tool for your customer

### medias Plus

In addition to using our medias platform, you can register for medias Plus. With your free membership you get access to advanced information and features. As a registered member, you can access exclusive content to support you with selection, configuration and ordering.

#### The perfect tool for you

### medias Business

As our registered business customers you have access to our medias Business section. Access our extended product catalogue and new features specifically designed to make the ordering process more efficient and enhance your interaction with Schaeffler.

**Visit us: <https://medias.schaeffler.co.uk>**

# TAPERED ROLLER BEARINGS

These accept high radial loads and axial loads in one direction. They are generally fitted opposite a bearing of the same type. Load capacity depends on contact angle.

## 1 ROW OF TAPERED BEARINGS



### Metric dimensions: ISO 355 and JIS B 1512 standards

Available with contact angles, spread from 10° to 30° and a large contact angle 40° (suffix D by NTN)

### Inch dimensions: ABMA standard (including J metric series)

Can be equipped with flanges

## 2 ROWS OF TAPERED BEARINGS



Appears in the same form as two single-row bearings

Fitted face-to-face or back-to-back, with metric or inch dimensions

One-piece outer or inner rings

Single-row assemblies with spacers also exist

## 4 ROWS OF TAPERED BEARINGS



Composed of two double cones, two single flanges and one double flange

Extended life cycle thanks to the use of case hardened steel, hollow rollers and pin-type cages

Very high load capacities, adapted to rolling type applications

Available in sealed version (-LL)

## ECO-TOP RANGE

Series meeting the need to protect the environment

Optimised design, enhanced life cycle, more compact bearing and reduced energy consumption



## NTN BOWER RANGE

Wide range of tapered roller bearings with inner diameters up to 16 inches

## Steel

Through hardened bearing steel (ECO-H)

Vacuum degassed case hardened steel (4T, ET) and special heat treatment for a longer life cycle (ETA / ECO)

## Cage

Generally equipped with a cage in pressed sheets

Solid or steel pin-type cages for large bearings

Fibre glass reinforced polyamide cage possible depending on the application for smaller bearings

## Contact torque



Bearing identified with the suffix -ST:

- Reduced drag torque
- Reduced heating
- Improved seizure resistance
- Simplified adjustments at assembly

## Sealing

Possible variant: sealing at the large shoulder (suffixe -LX)

## NTN-SNR ULTAGE : better performance for your applications

The ULTAGE name comes from a combination of the terms "ULTIMATE" and "STAGE". It is a name that provides you with optimised performance as standard, with respect to several technical criteria

### PERFORMANCE COMPARISON

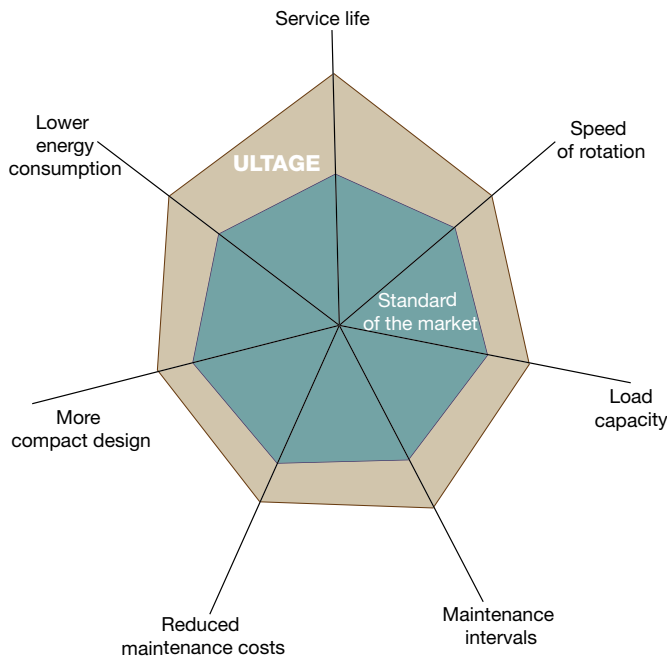

### FROM 25 MM BORE UP TO 2180 MM EXTERNAL DIAMETER

NTN-SNR offers the widest range of spherical roller bearings on the market. They are available in a range of cage versions.

#### PRESSED STEEL CAGE (EA)

In two parts, centred on the inner ring

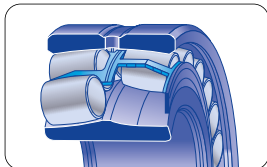

- > Reduced wear and friction
- > Optimum lubrication and high speeds

#### MACHINED SOLID BRASS CAGE (EM, L1)

Single-piece cage, centred on the bearing housing or the inner ring

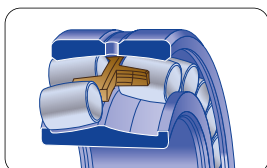

- > Extrem robustness for longer life in the most demanding environments.

#### SPECIAL CAGE FOR «VIBRATION APPLICATIONS» (EF800)

Single-piece cage with reduced bore, external diameter and radial clearance tolerances

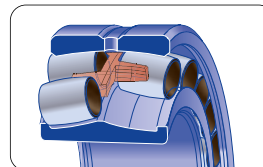

- > Extremely accurate roller guides for longer service life.

#### POLYAMIDE CAGE (EG15)

Two-part, centred on the inner ring.

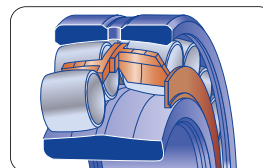

- > Performance and economy : elasticity and wrap-around profile for perfect guiding and reduced friction. (Max. running temperature 150°C)



THE FIRST SPHERICAL ROLLER BEARING WITH METALLIC SHIELDS

CUSTOMER BENEFITS

- Optimised production output due to longer service life
- Reduced maintenance costs
- Easy to use: **100% interchangeable** with open version

FIELD TESTS

1 Less bearing deterioration after twice service lifetime



QUARRY  
Conveyor



2 Maximized profits



CEMENT PLANT  
Bucket elevator

	Open spherical roller bearing	[KIZEI]
Life time	1 month	3 months
Production stops	12 times/year	4 times/year
Maintenance costs	100	30

Maintenance costs can be divided by 3



## TECHNICAL FEATURES

### 7 GOOD REASONS TO CHOOSE KIZEI®

- **ULTAGE** load ratings and speed
- ISO dimensions
- High Quality nitrided steel cage and shields
- Wide working temperature range (-40° C up to +200° C)
- Easy lubrication (initial lubrication identical to open version)
- Optimal misalignment
- Simple mounting (same procedure and accessories than open version)



## AVAILABLE RANGE

22208  
22209  
22210  
22211  
22212  
22213  
22215  
22216  
22217  
22218  
22220

- Cylindrical or tapered bore
- Normal or C3 internal clearance

	OPEN	[KIZEI]	SEALED
Dimensions	ISO	ISO	Special
Protection	0	+	++
Grease retention	0	+	++
Temperature range	-40°C to +200°C	-40°C to +200°C	-10°C to +120°C
Speed limit	++	++	+
Load rating	Ultage	Ultage	Ultage
Clearance check	Yes	Yes	No
Internal check	Yes	Yes	No
Sleeve & Nut	Standard	Standard	Special
Delivered with grease	No	No	Yes

\* Suitable for solid dust proofing – no liquids.

Typical designation >> 22212EAKW33ZC3

Would you need an additional reference, please contact NTN-SNR

Download KIZEI® catalogue on our website:  
[www.ntn-snr.com](http://www.ntn-snr.com)



## NEEDLE BEARINGS

These bearings are mainly selected for constructions requiring reduced radial dimensions and maximum rigidity and load capacity. They have little resistance for axial forces (except thrusts and combined bearings).

### NEEDLE ROLLER AND CAGE ASSEMBLIES



**A needle cage comprises an inseparable cage and needles and can be used to design very compact, light, constructions with maximum capacity. The shaft and housing act as a raceway and must be machined in compliance with hardness, geometry and roughness characteristics. The needles are guided precisely, therefore the needle cage can absorb much higher speeds of rotation than contact needles.**

Depending on the application, different types of materials and cages are available:

Types	Characteristics	Suffixes
K	Fibre glass reinforced polyamide	-T2
K or KJ	Welded pressed steel cage	-S
GK / GPK	In two parts	
K	Two rows	-ZW
KBK	For piston pins application	
KV	For piston pins application	-S
PK / GPK	For crank pins application	
KMJ	For crank pins application	-S

Inch solutions are also available (PCJ).

### DRAWN CUP NEEDLE ROLLER BEARINGS



**Compact and light, mainly used in applications with low loads, needle sockets represent a low-cost bearing solution; the outer ring is not machined, but is obtained using precision pressing processes. It must be noted that the geometry of the raceway depends on the geometry of the housing (the low thickness of the outer ring only provides the hardness and roughness necessary for the raceway).**

Standard (HK) and heavy (HMK) series, available with or without sealing, with open or closed ends (BK, BMK)

Some dimensions are delivered with 2 rows of needles (-ZW)

Inches versions with cage (DCL, SCE) and contact needle versions (HCK).

NTN drawn cup needle roller bearing offer:

- simplified adapting thanks to an ideal geometry
- an improved life cycle: specific treatment of the cage and needles

### NEEDLE ROLLER BEARINGS WITH SOLID RINGS



**Needle roller bearings with solid rings are mainly used in applications with high loads.**

- **Inseparable versions:** with or without an inner ring
    - Series 48, 49, 59 and 69. (Series 49 is also available with simple or double sealing)
    - NK series: also deliverable with the inner ring (NK+IR designation)
- If the bearing is used without an inner ring, the shaft will act as a raceway and must be machined appropriately

**Separable versions:** RNAO and NAO

With these versions, the inner and outer rings and the cage can be separated, opening up more assembly options.



**The inner rings** are delivered separately.

Versions with plunge grinding for seal support surfaces are also available.

These solid rings and needle bearings are also available in inch dimensions. (MR,MI)

## NEEDLE AND ROLLER THRUST BEARINGS



**Needle or roller thrust bearings are designed to absorb axial forces in one direction only. Support surfaces used as raceways must be ground and hardened.**

- Needle thrust bearings: type AXK11
- Roller thrust bearings: series 811, 812, 874 and 893  
Available with Polyamide cage (-T2), Aluminium alloy cage (-: lightness and enhanced performance when lack of lubricant) or pressed steel cage.

Washers:

- type **AS11** washers are thin (1 mm), therefore their support surfaces must be flat and rigid enough
- types **WS** (centered on the shaft) and **GS** (centered on the housing) are more rigid

## COMBINED BEARINGS



**When the application requires resistance to forces combined with substantial rigidity or minimum room, the use of combined bearings can lead to benefits. Depending on the type of bearings, axial forces may be absorbed in one or two directions.**

**● Uni-directional axial forces**

The thrust part may comprise, either:

- a radial contact (NKX) or angular contact (NKIA) ball bearing
- rollers for high axial loads (NKXR)

If the unit must be inseparable, a flange (-Z) is proposed

**Two-way axial forces**

Depending on the intensity of the forces, the thrust part will consist of needles (AXN) or rollers (ARN)

## CAM FOLLOWERS



**Cam followers are used for applications requiring guidance with minimum contact with cam and the linear guidance systems.**

**Cam followers applications are very different to bearing applications. The cam followers is not fitted in a housing and its thicker outer ring rolls directly over a surface to provide guidance.**

With or without a seal, with an outer ring with a convex or cylindrical profile, all cam followers are proposed:

- contact needle version (KRV-NATV) to accept significant loads
- cage version (KR-NATR) to accept higher speeds

Versions with two 2 rows of contact bearings also exist to increase capacity (NUTR, NUTW et NUKR)

- Stud Type: threaded shaft has a slot head or hex head screwdriver tightening system to simplify the attachment of the roller on the support surface. These rollers may be regreased by the shaft.
- Yoke Type: with or without lateral guidance



# BEARING UNITS

www.ntn-snr.com



With You

With years of expertise, our wide range of bearing units and bearing inserts offers a complete choice to our customers.

## BENEFITS

### One stop shop for all your bearing unit needs

Full assortment of quality products from JIS and ISO ranges

### Improve your reactivity thanks to short lead times

High level of product availability in our European Distribution Center

### Optimize the output of your machines with our complete product expertise

Benefit from the advice of our highly skilled engineering team for your specific applications

## BEARING UNIT RANGE



### GREY CAST IRON THE POPULAR RANGE

- JIS & ISO ranges
- Available from shaft diameter 12 – 140 mm / ½ - 3 15/16 inch
- Equipped with universal G2 inserts
- Relubrication facilities as standard
- Blue painting with excellent anticorrosion properties
- Rigid protective covers from stainless steel
- Adapter sleeve already included



### PRESSED STEEL FOR ECONOMICAL AND LIGHTWEIGHT CONSTRUCTIONS

- Two-piece housing made from zinc coated sheet steel
- Available as pillow block, flanged or take-up unit
- Equipped with universal G2 inserts
- Suitable for narrow ball bearing inserts set screw type US..G2, eccentric locking collar type ES..G2 and type CS with interference fit
- Made for low to moderate loads & speeds



### HARSCH ENVIRONMENT STAINLESS STEEL

#### WHEN CORROSION RESISTANCE & OXIDATION PROTECTION IS NEEDED

- 100% stainless steel resistant to corrosion: will never chip and contaminate the end product
- Food-grade seal with additional slinger (SUC)
- USDA H1 grease fully compliant with FDA regulations
- Shaft fastening by set screw or eccentric locking collar
- Protective covers to provide additional protection against regular washdowns



### ECONOMICAL SOLUTION THERMOPLASTIC

- 100% stainless steel bearing inserts resistant to corrosion: will never chip and contaminate the end product
- All metallic components made of high-quality stainless steel
- Housings equipped with grooves to snap protective covers into place
- USDA H1 grease fully compliant with FDA regulations
- Good friction and wear properties

## BEARING INSERT SOLUTIONS BEYOND THE STANDARD



GREASED FOR LIFE



### LUBSOLID®

- Made of high-quality stainless steel
- Food grade lubricant with NSF certificate
- Anti-contamination effect: no lubricant leakage possible

### BENEFITS

COST SAVINGS AND PRODUCTIVITY GAINS  
 LOWER MAINTENANCE AND MATERIAL COSTS  
 SUITED FOR LOCATIONS WITH DIFFICULT ACCESS:  
 NO NEED FOR REGULAR MONITORING OR SERVICE



HYGIENE STANDARDS

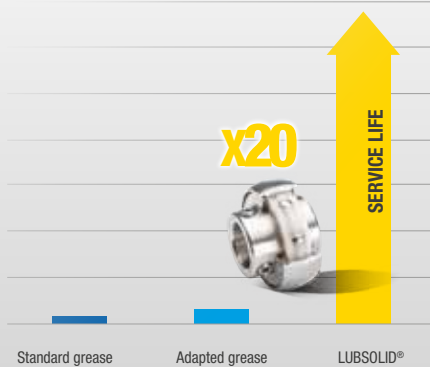

For use with stainless steel and thermoplastic housings.

### AGR

- High durability and resistant to strong impacts
- Maintenance-free
- Resistant to high pressure washing

### BENEFITS

COST SAVING AND PRODUCTIVITY GAINS  
 LOWER MAINTENANCE AND MATERIAL COSTS  
 BETTER OPERATING PERFORMANCE

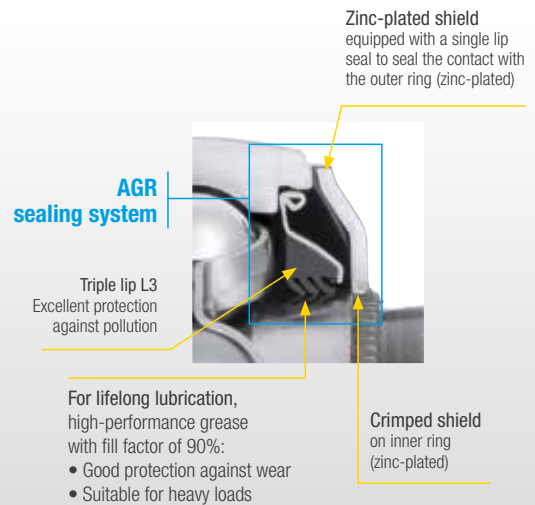

### CAUTION

With a few exceptions, these bearing inserts fit most cast iron housings. For customized bearing units, please consult the technical department to let them check for feasibility.

Download our new catalogue on: [www.ntn-snr.com](http://www.ntn-snr.com)

NTN-SNR ROULEMENTS - 1 rue des usines - 74000 Annecy  
 RCS ANNECY B 325 821 072 - Code APE 2815Z - Code NACE 28.15  
[www.ntn-snr.com](http://www.ntn-snr.com)

DOC\_L\_BU\_MEMO\_GBa - NTN-SNR Copyright International 08/2020 - Conception : NTN-SNR - Photos : Pedro Studio Photo



With You



## SNC PLUMMER BLOCK



Efficient, flexible and user friendly



With You

### More than Standard!

#### Extend the life duration with the SNC plummer block housing range!

The optimized design provides excellent rigidity and stability, a vibration dampening and improves strength and heat dissipation characteristics in order to provide reduced stress levels in the bearing and a cooler running temperature of its lubricant and thereby extending operating and service life.

#### The solution for higher loads

Large SNC plummer block housings (from the size 520) are now also available in ductile iron EN-GJS-400-18. This SNC D designated housing features additional a factor 1.8 higher breaking loads.

The SNC plummer block housings are designed for installation of spherical roller bearings.

We recommend the use of our ULTAGE spherical roller bearings with higher increased load capacities and extended service life, to take advantage of the optimal characteristics of the SNC-Housings. We complete our range with the tools and solutions of Experts & Tools.



### Your benefits:

#### Circular reinforcement:

- excellent stability + rigidity
- optimal vibration behavior
- effective heat dissipation



#### Connection options:

- delivered with 2 lubrication holes
- 2 grease nipples (1x tapered, 1x flat headed nipple) added
- all bores sealed with screws
- drain hole



#### X-support:

- reinforced bearing seat
- uniform load distribution
- extended life in service

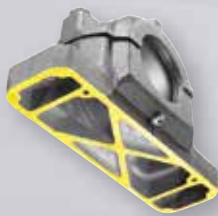

#### Larger diameter bolts:

- higher radial loads to be supported by the housing cap



#### Optional grease regulation disc:

- achieves the normal operating temperature more quickly
- at high rotational speeds: reduces the operating temperature
- extends the operating and service life of the bearing

### Sealing options

A variety of sealing options is available, adapted to your application



**SC..DS**  
Double lip seal  
allround use

**SC..FS**  
Felt strip seal  
high rotation speed

**SC..SV**  
V-Ring seal  
low friction

**SC..LA**  
Labyrinth seal  
high temperatures

**SC..TA**  
Taconite seal  
large dust pollution

With our ULTAGE spherical roller bearings you will have a perfect combination for your application, like for ex.:

- Industrial ventilators
- Mining and quarry
- etc.
- Conveyor systems
- Steel industry



## SNC PLUMMER BLOCK









Efficient, flexible and user friendly



With You

**SNR ↔ SKF**  
Interchange list  
Split plummer block units

Shaft outlet-Ø	Typ	SNR ↔ SKF Interchange list		SNR		SKF	
		SNC 	SNL 	DS 	G 	FS 	C 
20	505	SNC505	SNL505	SC505DS	TSN505G	SC505FS	TSN505C
20	605	SNC506-605	SNL506-605	SC605DS	TSN605G	SC605FS	TSN605C
25	506	SNC506-605	SNL506-605	SC506DS	TSN506G	SC506FS	TSN506C
25	606	SNC507-606	SNL507-606	SC606DS	TSN606G	SC606FS	TSN606C
30	205	SNC205	SNL205	SC205DS	TSN205G	SC205FS	-
30	305	SNC206-305	SNL206-305	SC507DS	TSN305G	SC305FS	-
30	507	SNC507-606	SNL507-606	SC507DS	TSN507G	SC507FS	TSN507C
30	607	SNC508-607	SNL508-607	SC607DS	TSN607G	SC607FS	TSN607C
35	206	SNC206-305	SNL206-305	SC206DS	TSN206G	SC206FS	-
35	306	SNC507-606	SNL507-606	SC206DS	TSN206G/306G	SC206FS	-
35	508	SNC508-607	SNL508-607	SC508DS	TSN508G	SC508FS	TSN508C
35	608	SNC510-608	SNL510-608	SC608DS	TSN608G	SC608FS	TSN608C
45	207	SNC207-306	SNL207	SC207DS	TSN207G	SC207FS	-
45	307	SNC208-307	SNL208-307	SC510DS	TSN307G	SC307FS	-
40	509	SNC509	SNL509	SC509DS	TSN509G	SC509FS	TSN509C
40	609	SNC511-609	SNL511-609	SC609DS	TSN609G	SC609FS	TSN609C
50	208	SNC208-307	SNL208-307	SC208DS	TSN208G	SC208FS	-
50	308	SNC510-608	SNL510-608	SC208DS	TSN208G/308G	SC208FS	-
45	510	SNC510-608	SNL510-608	SC510DS	TSN510G	SC510FS	TSN510C
45	610	SNC512-610	SNL512-610	SC610DS	TSN610G	SC610FS	TSN610C
55	209	SNC209	SNL209	SC209DS	TSN209G	SC209FS	-
55	309	SNC511-609	SNL511-609	SC209DS	TSN209G/309G	SC209FS	-
50	511	SNC511-609	SNL511-609	SC511DS	TSN511G	SC511FS	TSN511C
50	611	SNC513-611	SNL513-611	SC611DS	TSN611G	SC611FS	TSN611C
60	210	SNC210-308	SNL210	SC210DS	TSN210G	SC210FS	-
60	310	SNC512-610	SNL512-610	SC210DS	TSN210G/310G	SC210FS	-
55	512	SNC512-610	SNL512-610	SC512DS	TSN512G	SC512FS	TSN512C
55	612	SNC515-612	SNL515-612	SC612DS	TSN612G	SC612FS	TSN612C
65	211	SNC211-309	SNL211	SC211DS	TSN211G	SC211FS	-
65	311	SNC513-611	SNL513-611	SC211DS	TSN211G/311G	SC211FS	-
60	513	SNC513-611	SNL513-611	SC513DS	TSN513G	SC513FS	TSN513C
60	613	SNC516-613	SNL516-613	SC613DS	TSN613G	SC613FS	TSN613C
70	212	SNC212-310	SNL212	SC212DS	TSN212G	SC212FS	-
70	312	SNC515-612	SNL515-612	SC212DS	TSN212G/312G	SC212FS	-
65	515	SNC515-612	SNL515-612	SC515DS	TSN515G	SC515FS	TSN515C
65	615	SNC518-615	SNL518-615	SC615DS	TSN615G	SC615FS	TSN615C
75	213	SNC213-311	SNL213	SC213DS	TSN213G	SC213FS	-
75	313	SNC516-613	SNL516-613	SC213DS	TSN213G/313G	SC213FS	-
70	516	SNC516-613	SNL516-613	SC516DS	TSN516G	SC516FS	TSN516C
70	616	SNC519-616	SNL519-616	SC616DS	TSN616G	SC616FS	TSN616C
80	214	SNC214	-	SC214DS	-	SC214FS	-
80	314	SNC517	SNL517	SC214DS	TSN314G	SC214FS	-
75	517	SNC517	SNL517	SC517DS	TSN517G	SC517FS	TSN517C
75	617	SNC520-617	SNL520-617	SC617DS	TSN617G	SC617FS	TSN617C
85	215	SNC215-312	SNL215	SC215DS	TSN215G	SC215FS	-
85	315	SNC518-615	SNL518-615	SC215DS	TSN215G/315G	SC215FS	-
80	518	SNC518-615	SNL518-615	SC518DS	TSN518G	SC518FS	TSN518C
80	618	SNC318-618	-	SC618DS	-	SC618FS	-
90	216	SNC216-313	SNL216	SC216DS	TSN216G	SC216FS	-
90	316	SNC219-316	SNL519-616	SC316DS	TSN316G	SC316FS	-
85	519	SNC519-616	SNL519-616	SC519DS	TSN519G	SC519FS	TSN519C
85	619	SNC522-619	SNL522-619	SC619DS	TSN619G	SC619FS	TSN619C
95	217	SNC217-314	SNL217	SC217DS	TSN217G	SC217FS	-
95	317	SNC220-317	SNL520-617	SC317DS	TSN317G	SC317FS	-
90	520	SNC520-617	SNL520-617	SC520DS	TSN520G	SC520FS	TSN520C
90	620	SNC524-620	SNL524-620	SC620DS	TSN620G	SC620FS	TSN620C
100	218	SNC218-315	SNL218	SC218DS	TSN218G	SC218FS	-
100	318	SNC318-618	-	SC318DS	-	SC318FS	-
110	319	SNC222-319	SNL522-619	SC319DS	-	SC319FS	-
110	219	SNC519-616	-	SC219DS	-	SC219FS	-
100	522	SNC522-619	SNL522-619	SC522DS	TSN522G	SC522FS	TSN522C
115	220	SNC520-617	SNL520-617	SC220DS	TSN220G	SC220FS	-
115	320	SNC224-320	SNL524-620	SC320DS	-	SC320FS	-
110	524	SNC524-620	SNL524-620	SC524DS	TSN524G	SC524FS	TSN524C
125	222	SNC522-619	SNL522-619	SC222DS	TSN222G	SC222FS	-
115	526	SNC226-526	SNL526	SC526DS	TSN526G	SC526FS	TSN526C
135	224	SNC524-620	SNL524-620	SC224DS	TSN224G	SC224FS	-
125	528	SNC228-528	SNL528	SC528DS	TSN528G	SC528FS	TSN528C
145	226	SNC226-526	SNL526	SC226DS	TSN226G	SC226FS	-
135	530	SNC230-530	SNL530	SC530DS	TSN530G	SC530FS	TSN530C
140	532	SNC232-532	SNL532	SC532DS	TSN532G	SC532FS	TSN532C
155	228	SNC228-528	SNL528	SC228DS	TSN228G	SC228FS	-
165	230	SNC230-530	SNL530	SC230DS	TSN230G	SC230FS	-
175	232	SNC232-532	SNL532	SC232DS	TSN232G	SC232FS	-





# SNC PLUMMER BLOCK



Efficient, flexible and user friendly



With You

							
SNR SV	SKF A	SNR LA	SKF S	SNR TA	SKF ND	SNR EC	SKF ANSH
SC505SV	TSN505A	SC505LA	TSN505S	SC505TA	TSN505ND	SC505EC	ASNH505
SC605SV	TSN605A	SC605LA	TSN605S	SC605TA	TSN605ND	SC506-605EC	ASNH506-605
SC506SV	TSN506A	SC506LA	TSN506S	SC506TA	TSN506ND	SC506-605EC	ASNH506-605
SC606SV	TSN606A	SC606LA	TSN606S	SC606TA	TSN606ND	SC507-606EC	ASNH507-606
-	-	SC205LA	TSN205S	SC205TA	TSN205ND	SC506-605EC	ASNH506-605
SC305SV	TSN305A	SC305LA	TSN305S	SC305TA	TSN305ND	SC507-606EC	ASNH507-606
SC507SV	TSN507A	SC507LA	TSN507S	SC507TA	TSN507ND	SC507-606EC	ASNH507-606
SC607SV	TSN607A	SC607LA	TSN607S	SC607TA	TSN607ND	SC508-607EC	ASNH508-607
SC206SV	TSN206A	SC206LA	TSN206S	SC206TA	TSN206ND	SC507-606EC	ASNH507-606
SC206SV	TSN206A/306A	SC206LA	TSN206S/306S	SC206TA	TSN206ND/306ND	SC507-606EC	ASNH507-607
SC508SV	TSN508A	SC508LA	TSN508S	SC508TA	TSN508ND	SC508-607EC	ASNH508-607
SC608SV	TSN608A	SC608LA	TSN608S	SC608TA	TSN608ND	SC510-608EC	ASNH510-608
SC207SV	TSN207A	SC207LA	TSN207S	SC207TA	TSN207ND	SC509EC	ASNH509
SC307SV	TSN307A	SC307LA	TSN307S	SC307TA	TSN307ND	SC510-608EC	ASNH510-608
SC509SV	TSN509A	SC509LA	TSN509S	SC509TA	TSN509ND	SC509EC	ASNH509
SC609SV	TSN609A	SC609LA	TSN609S	SC609TA	TSN609ND	SC511-609EC	ASNH511-609
SC208SV	TSN208A	SC208LA	TSN208S	SC208TA	TSN208ND	SC510-608EC	ASNH510-608
SC208SV	TSN208A/308A	SC208LA	TSN208S/308S	SC208TA	TSN208ND/308ND	SC510-608EC	ASNH510-609
SC510SV	TSN510A	SC510LA	TSN510S	SC510TA	TSN510ND	SC510-608EC	ASNH510-608
SC610SV	TSN610A	SC610LA	TSN610S	SC610TA	TSN610ND	SC512-610EC	ASNH512-610
SC209SV	TSN209A	SC209LA	TSN209S	SC209TA	TSN209ND	SC511-609EC	ASNH511-609
SC209SV	TSN209A/309A	SC209LA	TSN209S/309S	SC209TA	TSN209ND/309ND	SC511-609EC	ASNH511-610
SC511SV	TSN511A	SC511LA	TSN511S	SC511TA	TSN511ND	SC511-609EC	ASNH511-609
SC611SV	TSN611A	SC611LA	TSN611S	SC611TA	TSN611ND	SC513-611EC	ASNH513-611
SC210SV	TSN210A	SC210LA	TSN210S	SC210TA	TSN210ND	SC512-610EC	ASNH512-610
SC210SV	TSN210A/310A	SC310LA	TSN210S/310S	SC210TA	TSN210ND/310ND	SC512-610EC	ASNH512-611
SC512SV	TSN512A	SC512LA	TSN512S	SC512TA	TSN512ND	SC512-610EC	ASNH512-610
SC612SV	TSN612A	SC612LA	TSN612S	SC612TA	TSN612ND	SC515-612EC	ASNH515-612
SC211SV	TSN211A	SC211LA	TSN211S	SC211TA	TSN211ND	SC513-611EC	ASNH513-611
TSN211A/311A	SC211LA	TSN211S/311S	SC211TA	TSN211ND/311ND	SC513-611EC	ASNH513-612	ASNH513-611
SC513SV	TSN513A	SC513LA	TSN513S	SC513TA	TSN513ND	SC513-611EC	ASNH513-611
SC613SV	TSN613A	SC613LA	TSN613S	SC613TA	TSN613ND	SC516-613EC	ASNH516-613
SC212SV	TSN212A	SC212LA	TSN212S	SC212TA	TSN212ND	SC515-612EC	ASNH515-612
SC212SV	TSN212A/312A	SC212LA	TSN212S/312S	SC212TA	TSN212ND/312ND	SC515-612EC	ASNH515-613
SC515SV	TSN515A	SC515LA	TSN515S	SC515TA	TSN515ND	SC515-612EC	ASNH515-612
SC615SV	TSN615A	SC615LA	TSN615S	SC615TA	TSN615ND	SC518-615EC	ASNH518-615
SC213SV	TSN213A	SC213LA	TSN213S	SC213TA	TSN213ND	SC516-613EC	ASNH516-613
SC213SV	TSN213A/313A	SC213LA	TSN213S/313S	SC213TA	TSN213ND/313ND	SC516-613EC	ASNH516-614
SC516SV	TSN516A	SC516LA	TSN516S	SC516TA	TSN516ND	SC516-613EC	ASNH516-613
SC616SV	TSN616A	SC616LA	TSN616S	SC616TA	TSN616ND	SC519-616EC	ASNH519-616
SC214SV	-	SC214LA	-	SC214TA	-	SC517EC	-
SC214SV	TSN314A	SC214LA	TSN314A	SC214TA	TSN314ND	SC517EC	ASNH516
SC517SV	TSN517A	SC517LA	TSN517S	SC517TA	TSN517ND	SC517EC	ASNH517
SC617SV	TSN617A	SC617LA	TSN617S	SC617TA	TSN617ND	SC520-617EC	ASNH520-617
SC215SV	TSN215A	SC215LA	TSN215S	SC215TA	TSN215ND	SC518-615EC	ASNH518-615
SC215SV	TSN215A/315A	SC215LA	TSN215S/315S	SC215TA	TSN215ND/315ND	SC518-615EC	ASNH518-614
SC518SV	TSN518A	SC518LA	TSN518S	SC518TA	TSN518ND	SC518-615EC	ASNH518-615
SC618SV	-	SC618LA	-	SC618TA	-	SC318-618EC	-
SC216SV	TSN216A	SC216LA	TSN216S	SC216TA	TSN216ND	SC216-613EC	ASNH216
SC316SV	TSN316A	SC316LA	TSN316S	SC316TA	TSN316ND	SC519-616EC	ASNH519-616
SC519SV	TSN519A	SC519LA	TSN519S	SC519TA	TSN519ND	SC519-616EC	ASNH519-616
SC619SV	TSN619A	SC619LA	TSN619S	SC619TA	TSN619ND	SC522-619EC	ASNH522-619
SC217SV	TSN217A	SC217LA	TSN217S	SC217TA	TSN217ND	SC217-314EC	ASNH217
SC317SV	TSN317A	SC317LA	TSN317S	SC317TA	TSN317ND	SC520-617EC	ASNH520-617
SC520SV	TSN520A	SC520LA	TSN520S	SC520TA	TSN520ND	SC520-617EC	ASNH520-617
SC620SV	TSN620A	SC620LA	TSN620S	SC620TA	TSN620ND	SC524-620EC	ASNH524-620
SC218SV	TSN218A	SC218LA	TSN218S	SC218TA	TSN218ND	SC218-315EC	ASNH218
SC318SV	-	SC318LA	-	SC318TA	-	SC318-618EC	-
SC319SV	TSN319A	SC319LA	TSN319S	SC319TA	TSN319ND	SC522-619EC	ASNH522-619
SC219SV	-	SC219LA	-	SC219TA	-	SC519-616EC	-
SC522SV	TSN522A	SC522LA	TSN522S	SC522TA	TSN522ND	SC522-619EC	ASNH522-619
SC220SV	TSN220A	SC220LA	TSN220S	SC220TA	TSN220ND	SC520-617EC	ASNH520-617
SC320SV	TSN320A	SC320LA	TSN320S	SC320TA	TSN320ND	SC524-620EC	ASNH524-620
SC524SV	TSN524A	SC524LA	TSN524S	SC524TA	TSN524ND	SC524-620EC	ASNH524-620
SC222SV	TSN222A	SC222LA	TSN222S	SC222TA	TSN222ND	SC522-619EC	ASNH522-619
SC526SV	TSN526A	SC526LA	TSN526S	SC526TA	TSN526ND	SC226-626EC	ASNH526
SC224SV	TSN224A	SC224LA	TSN224S	SC224TA	TSN224ND	SC524-620EC	ASNH524-620
SC528SV	TSN528A	SC528LA	TSN528S	SC528TA	TSN528ND	SC228-528EC	ASNH528
SC226SV	TSN226A	SC226LA	TSN226S	SC226TA	TSN226ND	SC226-526EC	ASNH526
SC530SV	TSN530A	SC530LA	TSN530S	SC530TA	TSN530ND	SC230-530EC	ASNH530
SC532SV	TSN532A	SC532LA	TSN532S	SC532TA	TSN532ND	SC232-532EC	ASNH532
SC228SV	TSN228A	SC228LA	TSN228S	SC228TA	TSN228ND	SC228-528EC	ASNH528
SC230SV	TSN230A	SC230LA	TSN230S	SC230TA	TSN230ND	SC230-530EC	ASNH530
SC232SV	TSN232A	SC232LA	TSN232S	SC232TA	TSN232ND	SC232-532EC	ASNH532



## THE BEARING BOX



www.ntn-snr.com



With You



## BEBOX

**With the help of our experts, you boost the operational efficiency of your business:**

- **By cutting** your maintenance costs
- **By training you** in best practise
- **Decrease machinery** down time
- **Identify root** cause issues

### Training:

- **100% adapted** to your needs
- **Theory:** Basics, bearing technology, bearing life, lubrication, clearance
- **Practical:** Training, demonstration with tools
- **Bearing lubrication**



NTN Bearings UK Ltd  
Wellington Crescent, Fradley Park,  
Lichfield, WS13 8RZ  
[www.ntn-snr.com](http://www.ntn-snr.com)

**Reserve the Bearing Box today!**  
**Talk to us to discuss the tailored training options to suit your requirements.**

# DEEP GROOVE BALL BEARINGS TOPLINE



www.ntn-snr.com



With You

Since 1997, TOPLINE has been the unique range of bearings for extreme applications. In 2020, it will be renewed thanks to two technical evolutions.

## STRENGTHS

A HIGHLY TECHNICAL RANGE READY TO USE AND AVAILABLE FROM STOCK.

## OUR RANGE

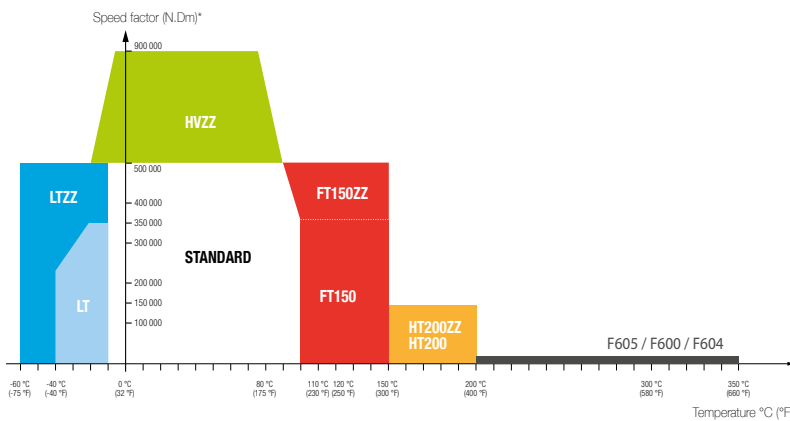

### TECHNICAL FACTSHEET

**Series:** 6000, 6200, 6300

**Diameters:** bore code 00 to 13 \*\*

**Sealing type:** seals or shields, except F600 and F605

**Types :**

**HVZZ** : High Speed up to 900 000 N.Dm

**LT** : Low Temperature -40°C

**FT150** : High temperature up to 150°C

**HT200** : High temperature up to 200°C

**F60x** : Up to 350°C

\* N.Dm is a speed factor where N is the speed of rotation in rpm and Dm is the average diameter of the bearing (d + D)/2

\*\* Variable according to types and series

## BENEFITS AND 2020 IMPROVEMENTS

BY RENEWING OUR TECHNICAL CHOICES ON GREASES,  
WE IMPROVE PERFORMANCE OF TWO OF OUR RANGES:



**FT150 : Quieter with a noise level reduced by a factor of 4**

Able to propose the best solution for your customers increasing demands



**Up to 140rpm for F604 - Performance x 3**

Target a range of wider applications

Download our new catalogue on: [www.ntn-snr.com](http://www.ntn-snr.com)

NTN-SNR ROULEMENTS - 1 rue des usines - 74000 Annecy  
RCS ANNECY B 325 821 072 - Code APE 2815Z - Code NACE 28.15  
[www.ntn-snr.com](http://www.ntn-snr.com)

DOC\_I\_TOPLINE\_MEMO\_GBa - NTN-SNR Copyright International 09/2020 - Conception : NTN-SNR - Photos : Pedro Studio Photo



With You

## TECHNICAL CHARACTERISTICS

We use the best technologies available, so that each product is ideally geared towards your needs.

Products	Cage	Internal clearance	Grease	Sealing	Other	Temperature range
HVZZ	Glass fibre reinforced polyamide 6.6	C3	Superior quality. Lithium thickener + synthetic base oil	Steel shields	Precision P6, P5. High-precision balls (<= Class 10)	-20°C to +120°C
LT LTZZ	Steel	C3	Suited to low temperatures + presence of humidity. Lithium thickener + synthetic base oil	Nitrile rubber seals (NBR) or steel shields	-	LT: -40°C to +100°C LTZZ: -60°C to +120°C
FT150 FT150ZZ	Steel	C3	Adapted to high temperatures. Polyurea thickener + synthetic base oil	Fluoroelastomer seals (FKM) or steel shields	-	-30°C to +150°C
HT200 HT200ZZ	Steel	C4	Adapted to high temperatures. PTFE solid lubricant and PFPE oil	Fluoroelastomer seals (FKM) or steel shields	Specific heat treatment	-40°C to +200°C
F605	Steel	Multiple of C5*	**	-	Brand is stamped	Temperature range between +200°C and +350°C (continuous or cyclic)
F600	Steel	Multiple of C5*		-	Specific surface treatment (phosphatisation + MoS2 deposition)***	
F604	Steel	Multiple of C5*		Suitable for very high temperatures. Polyalkylene glycol base oil + solid additive	Steel shields	

For more information about the temperature ranges, please contact us.



\* Significantly increased internal clearance to offset the material's expansion effects.

\*\* In case of F600 and F605, if additional lubrication is required, an appropriate amount of grease may be introduced into the bearing. Contact NTN-SNR for more information.

\*\*\* Surface treatment for greater oxidation resistance and improved lubrication. Caution: F600 and F604 products must be used with care in damp environments, since MoS2 may react with water to produce sulphuric acid.

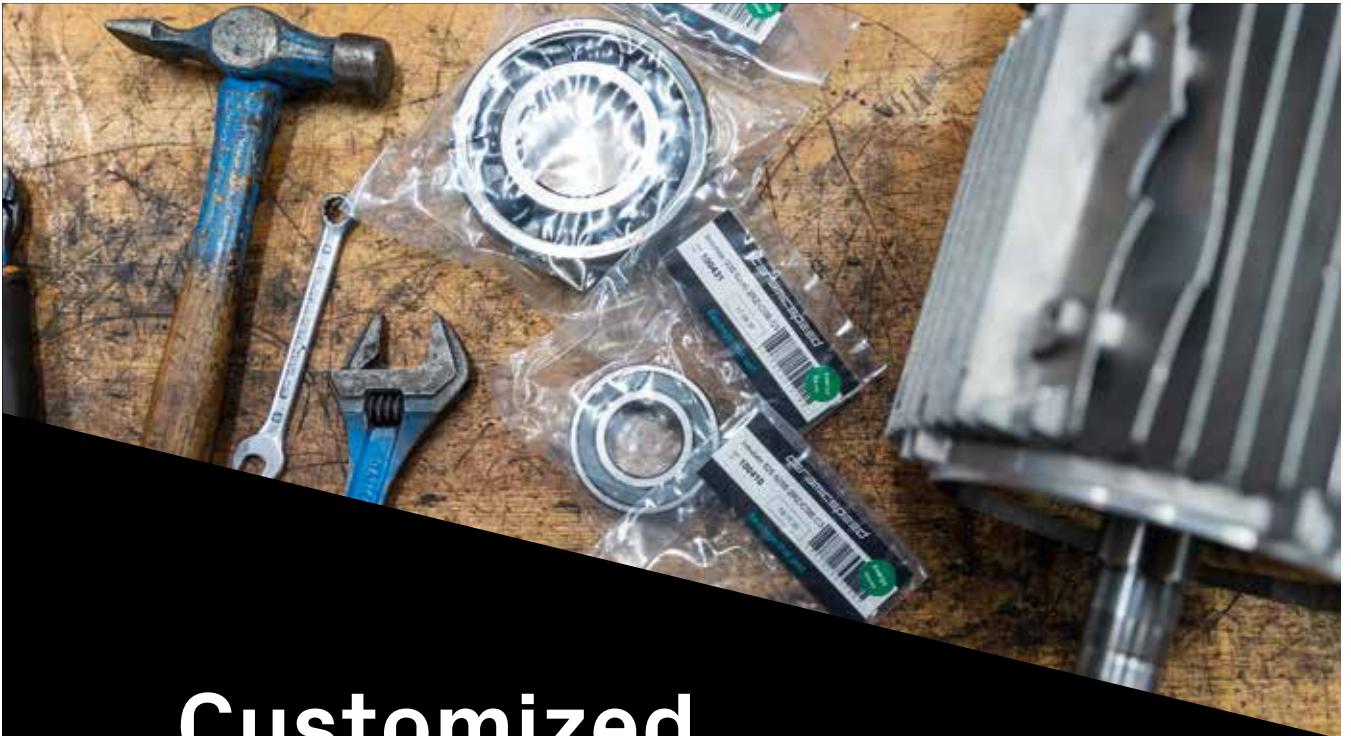

# Customized Hybrid Bearings - With Short Lead time



Food & Beverage



E-motor

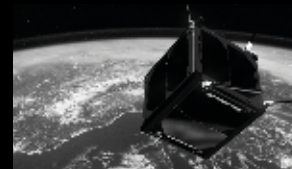

Special Applications

We offer fully customizable ceramic hybrid bearing solutions down to single unit inquiries for both e-motors, food and beverage and special application. We have more than 12 years of experience in the development of ceramic hybrid bearings for any application that does not fit the standard product categories and we take pride in the quality of our bearings and to hand build the right bearing for our customers.

 Hand Built in Denmark

**CERAMICSPEED**



## Barden Spindle Bearings

The Barden Corporation (UK) Ltd has more than 70 years of market-leading expertise in the design and manufacture of super precision ball bearings. Working together with international partners, Barden shares best practices and knowledge, delivering high-end bearings and assemblies tailor-made to the demands and requirements of customers.

Barden bearings are manufactured to the highest quality standards and the company offers a full range of engineering support services. Barden has a fast and flexible mindset which is rooted in all areas of the business.



## Products

Barden specialises in production of spindle ball bearings manufactured to the highest tolerance standards. The product range covers bearings from 3mm inner diameter up to 180mm outer diameter. The bearings are designed to offer exceptionally long lifetimes, extreme corrosion resistance if required and are suitable for high operating speeds.

Barden bearings are suitable for applications including motorised spindles, belt driven mechanical spindles, and specialist applications such as rotary unions for machine tool spindles. They provide excellent performance under the most demanding conditions.

## Quality

The tolerances for size, geometry and running accuracy of Barden spindle bearings fully comply with international ISO 492 and national DIN 620 standards, as well as American ABEC classes. Bearings are fitted with balls which meet the highest tolerance standards, 'Grade 5' as a minimum, and manufactured to ISO P4S as standard and up to P2 where required.

Barden has world leading systems and processes in place and a flexible approach to manufacturing. This, combined with large stocks of different product types, means customer demands can be fully met and product delivered quickly.



## Angular Contact Ball Bearings

Available in P4, P4S and P2 precision grade with 15° and 25° contact angles. Steel balls are supplied as standard. Universally ground for interchangeable mounting arrangements or in dedicated matched bearing sets.

## Optional Versions

### Sealed Bearings

Seals exclude contamination, contain lubricants and protect the bearing from internal damage during handling. Sealed and greased using non-contact seals, these bearings offer optimum performance in challenging applications.

### Direct Lubrication Version

Designed for maximum speed where radial oil lubrication systems are featured. As a rule the use of DLR (Direct Lube) bearings results in a reduction of running costs and proves more reliable than systems using axial oil supply.

## Ceramic Ball (Hybrid) Bearings

Ceramic balls used in place of steel balls can radically improve bearing performance in several ways:

- **Low vibration and noise.** Vibration levels can be up to seven times lower than conventional steel ball bearings. This is because ceramic balls are 60% lighter than steel balls and their surface finish is almost perfectly smooth.
- **High running speeds.** Ceramic hybrid bearings run at significantly lower operating temperatures, allowing running speeds to increase by up to 50%.
- **Low wear and long operating life.** Bearings with ceramic balls have been proven to last up to five times longer than conventional steel ball bearings. The inherent properties of silicon nitride mean the balls drastically reduce the predominant cause of surface wear in conventional bearings. Lower operating temperatures also help extend lubricant life and they provide excellent performance where there is insufficient lubrication.
- Systems equipped with ceramic hybrids show higher rigidity and higher natural frequency making them less sensitive to vibration.

## Applications and Industries

Barden super precision ball bearings are found throughout industry in applications where superior performance and reliability under challenging conditions is essential.

- |                       |                                      |                                  |
|-----------------------|--------------------------------------|----------------------------------|
| ■ Machine Tools:      | ■ Aerospace & Defence Industries     | ■ Medical & Dental Equipment     |
| ■ Grinding            | ■ Satellite Positioning Applications | ■ High Speed Electric Motors     |
| ■ Milling             | ■ Vacuum Pump Technologies           | ■ Spindle Repairers & Rebuilders |
| ■ Turning             | ■ Textile Equipment                  | ■ Machine Tool Repairers         |
| ■ Machining Centres   | ■ Food Processing                    | ■ Energy Generation Systems      |
| ■ Ball Screw Supports | ■ Robotics                           | ■ Other Specialist Applications  |





## AUSTRIAN QUALITY COMBINED WITH ADVANCED TECHNOLOGY



**NKE AUSTRIA GmbH is a premium bearing manufacturer with headquarters in Steyr, Austria. The company was founded in 1996 by a group of senior staff members of the former Steyr Wälzlager.**

NKE manufactures both standard and special bearings for all industrial applications. Our core competences - engineering, product development, final processing of components, assembly, quality assurance, logistics, sales and marketing - are centralised in Steyr. The site is accredited with ISO 9001:2015 (design, development, manufacturing and distribution of bearings), ISO 14001:2015 and OHSAS 18001.

**NKE bearings are distributed through international representative offices and more than 240 distribution outlets in over 60 countries.**

### We offer:

- / Standard bearings with a comprehensive stock range.
- / Tailor-made bearings for special requirements.
- / Technical service (e.g. consulting, documentation, training etc.)

### 100% Made in Austria



All NKE bearings are manufactured with state-of-the-art equipment. They undergo stringent and documented quality inspection. By using advanced testing and measuring equipment and applying a rigorous quality policy, we can guarantee that every single batch of bearings delivered is of the highest quality standards.

### Bearings move the world

Bearings are versatile and have contributed to change the world and make it as technologically advanced as it is today. Indeed, bearings move the world. The perfect combination of **quality, innovation and experience** in NKE bearings, are the **ideal choice for our distributors. Together: We are experts in bearing solutions!**

NKE Austria GmbH, in order to offer a complete range of bearings to its customers, regularly adds new products. The **stock programme is continuously changing and growing.** Greater availability of different types and sizes is one of NKE's goals.

In NKE's stock programme you can find:

Deep groove ball bearings (single and double row)	Washers
Cylindrical roller bearings including full complement	Conical sleeves
Needle roller bearings	Four point contact bearings
Insert bearings	Spherical roller bearings
Bearing housings	Self-aligning ball bearings
Axial cylindrical roller bearings	Thrust ball bearings
Spherical plain bearings	Angular contact ball bearings (single and double row)
Cam and track rollers, cam and track followers	Cylindrical roller thrust bearings
Locknuts	Tapered roller bearings

Imperials: LJ, MJ, LJT, MJT, LRJ, MRJ

Many of the advantages of rolling element bearings are:

- / Less starting torque, energy conservation
- / Capability to take on combined radial and axial loads
- / Greater load carrying capabilities
- / Maintenance free, sealed "for-life" design
- / Less lubrication consumption
- / Precise guidance of shafts
- / Suitable for greater operating temperatures

Since 2018 NKE is part of the Fersa Group, **present in more than 100 countries** with **4 factories** and **8 logistic centres** all over the world **with the only aim to be close to its customers.**

NKE develops and manufactures **premium quality** bearings for a wide spectrum of **industrial applications.**



**NKE electrically insulated bearings** – efficient and effective

NKE provides bearings with oxide ceramic insulating layers on the bearing ring. Applied with plasma technology, the insulation has a guaranteed breakdown resistance of at least 1000V AC or DC.

**Two variants are available:**

- / SQ77: Insulation on the outer ring
- / SQ77E: Insulation on the inner ring (Fig. right)



**Bearings for traction motors and railway gearboxes**

Traction motor bearings must demonstrate long service life, whereas gearbox bearings that operate under high speeds and loads, must endure shocks, vibrations and high temperatures. Equipped with engineering know-how and manufacturing expertise, NKE bearings for gearboxes and traction motors are usually produced with special specifications. (e.g. SQ1 for traction motors).

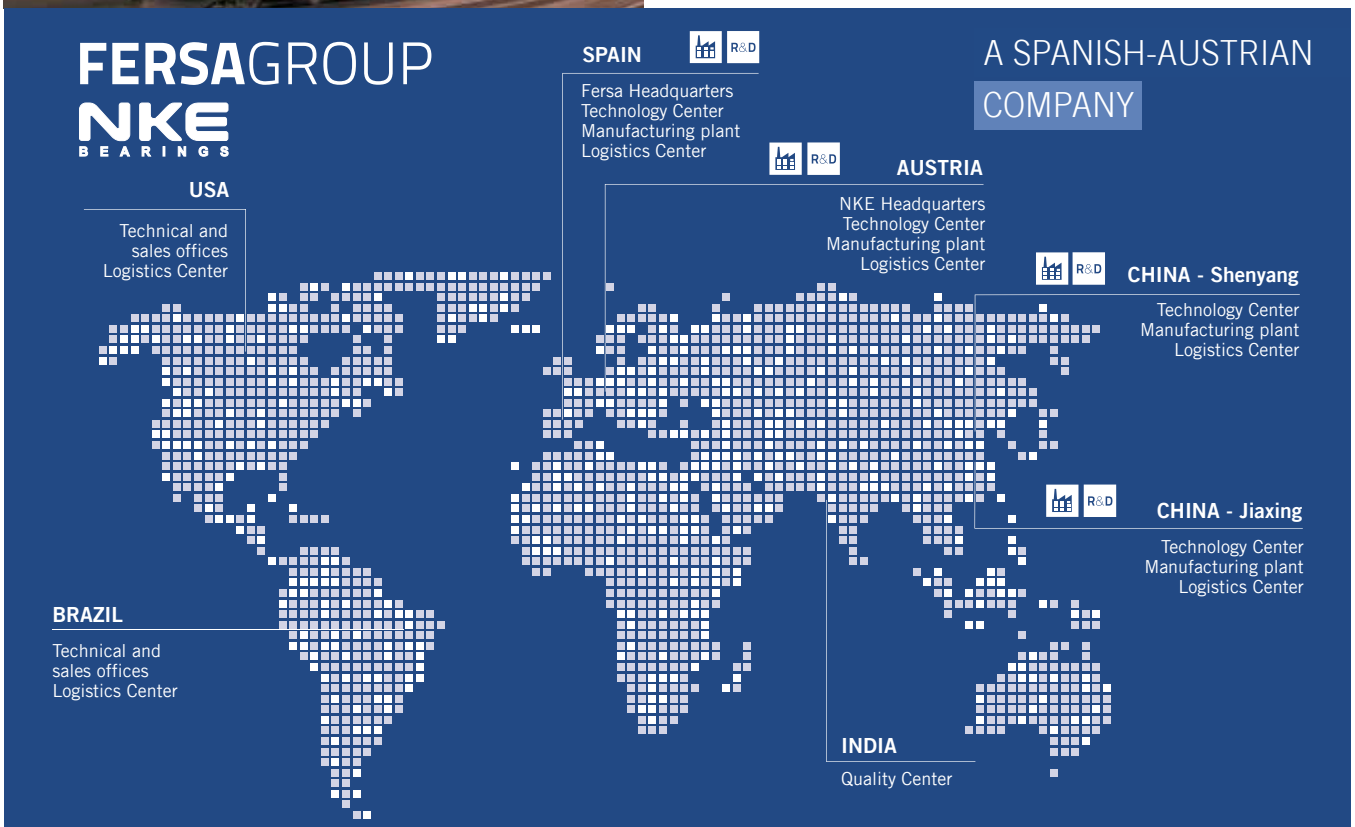



# THE FUTURE OF SPLIT BEARINGS IS HERE



**2 Year Warranty**  
Parts and Labour

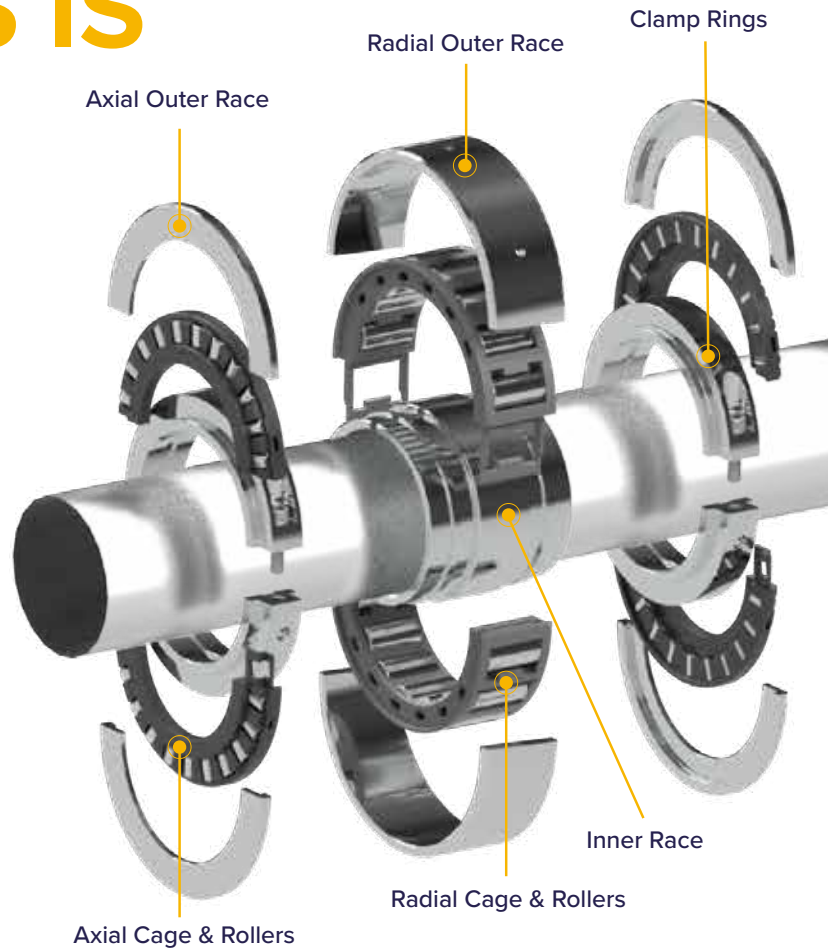

## ADVANCED SPHERICAL SPLIT ROLLER BEARINGS

Dramatically Reduced Downtime

Advanced Spherical Split Roller Bearing kits drop directly into the existing SN, SAF, SNL and SD housings. This has revolutionised the replacement of industrial and marine units as it allows the bearings to be replaced without having to remove the shaft or surrounding equipment.



Design and Manufactured in the UK

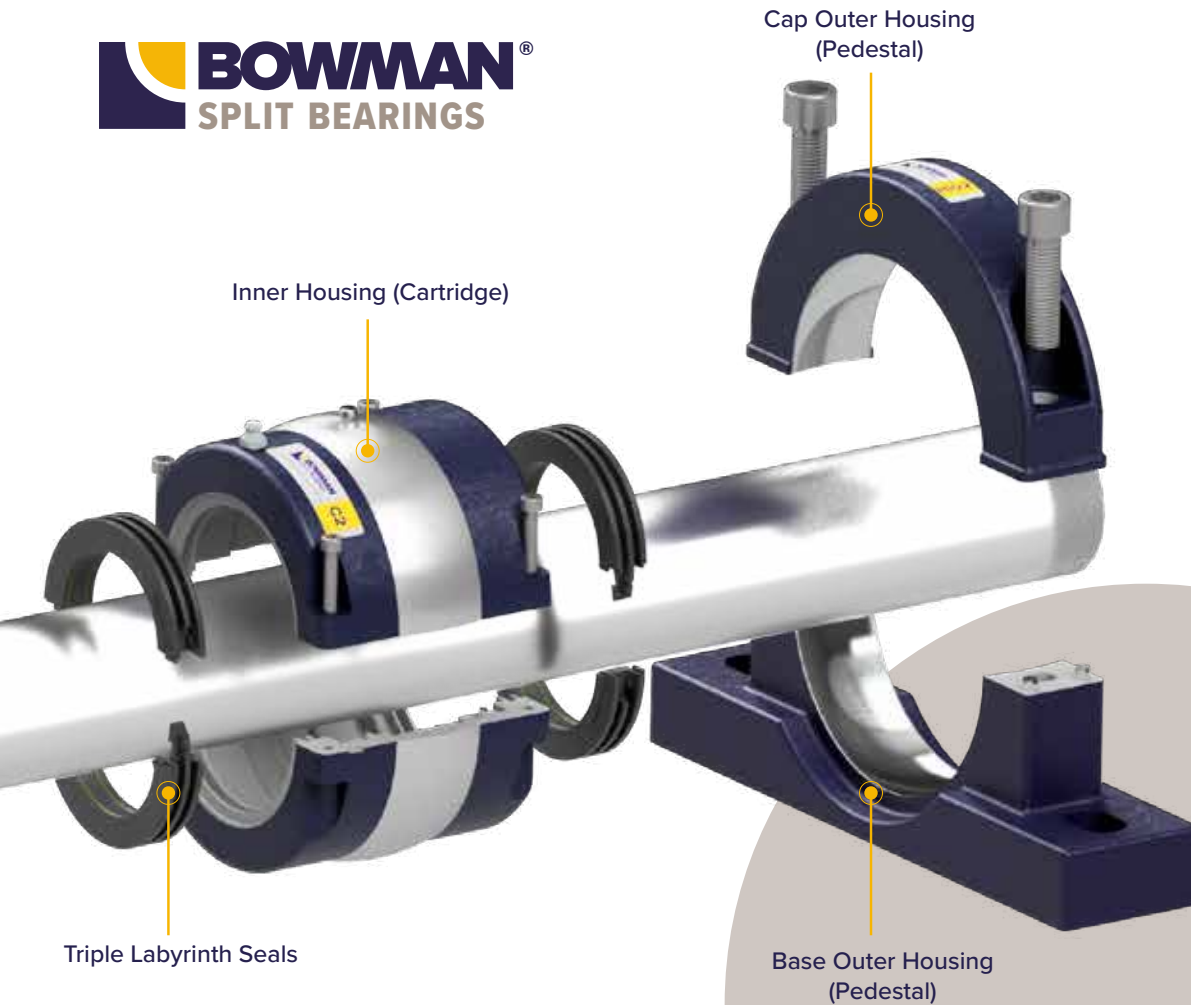

### ADVANCED SPLIT ROLLER BEARINGS

Up to 75% Higher Radial Load Capacity and Up to a 1000% Increase in Axial Load Capacity in Both Directions

- ▶ Dramatically reduced downtime
- ▶ The axial bearing design enables calculation of L10 life
- ▶ Stronger ductile (SG) cartridges and pedestals as standard
- ▶ Direct interchange with existing manufacturers outer housing
- ▶ Different Mounting Options
- ▶ Metric and Imperial Sizes
- ▶ Adaptions of the design can be accomdated
- ▶ Special extended seals are available which overcome worn shafts



## The industry standard

Oilite® has been acknowledged as the undisputed market leader in self-lubricating bearings for more than 80 years, and today sets the standard for other products with its quality and reliability.

The extensive technical knowledge and manufacturing resources behind Oilite® have resulted in a vast array of sophisticated, high quality components that are supplied to a wide range of industries, throughout the world.

### Widest range in Europe

As well as being the UK's number one choice, Oilite® bearings are also produced for other EU markets and offer the widest choice of self-lubricating bearings anywhere in Europe. Standard stock ranges are available in metric and inch. To ensure that customers have the benefit of fast delivery, a large range of European sizes are always stocked.

- 1000 European standard sizes
- Stock holding for fast delivery

There are now five standard stock ranges, ISO Metric, Inch, DIN 1850, French Metric and Scandinavian Metric.

### Bespoke products

Where customer requirements are not met by stock items, our bespoke service enables us to produce both bronze and iron bearings and customer specified structural parts that are specifically designed to meet individual requirements.

### Manufacturing quality and efficiency

Our manufacturing facilities are highly automated for maximum efficiency and competitiveness. Rigorous quality control procedures are adopted at all stages of manufacture.

### Custom Machining

We also specialise in machining Oilite® self-lubricating bearings and plates to meet individual specifications and tolerances. This service provides, for example, one-off requirements in machine maintenance or limited production runs in the OEM design field or for prototype testing before committing to tooling. Specialist tools and machining techniques are employed. This maintains the performance characteristics and physical properties which are the prerequisite of these components.

### Certification

The company is certified to the Quality Management Systems requirement of ISO 9001:2008 by LRQA Certificate No. LRQ0960929 and is approved for use by:

- Augusta Westland
- Messier Dowty
- Hawker Beechcraft Corporation

Certificates of conformity & Certificates of material analysis are supplied by request.

### Special Lubricants & Additives

The standard stock range of Oilite® bearings is impregnated with a mineral oil SAE 30 viscosity; all machined Oilite® bearings and plates are supplied fully impregnated after machining. A wide range of lubricants with varying temperature ranges are available to meet specific requirements. Lubricant additives are also available to impart anti-wear properties in marginal lubrication conditions such as stainless steel shaft applications.

### Technical Advice

Extensive technical resources are available to resolve bearing problems. Engineers are always available to discuss projects in detail, without obligation.

### Oilite® conforms to DIN 1850/ISO 2795

Oilite® metric bearings are manufactured to the tolerances set out in ISO 2795 - Plain Bearings from Sintered Material. The German stock range of bearings conform to DIN 1850.

### Material Choice

**Standard Oilite®** - oil retaining tin bronze is the generally specified material. It gives a good balance between strength, wear resistance, conformability and durability in operation. Ideal in a wide variety of applications where "self lubricating" properties are required over a long period of time.

**Super Oilite®** - an iron copper material suited to high static loads and slow oscillatory motion.

**Iron Oilite®** - 100% iron oil-retaining bearings provide an ideal solution in high stress low revolution applications.

## WMU® and W/MLF Self Lubricated Bearings WMX® Externally Lubricated Bearings



(Dimensions and tolerances to ISO 3547)

### Stock range includes

- Metric plain
- Metric flanged
- Metric washers
- Metric strip
- Imperial plain
- Imperial washers
- Imperial strip\*



(Dimensions and tolerances to ISO 3547)

### Stock range includes

- Metric plain
- Metric washers
- Metric strip
- Imperial plain\*
- Imperial washers\*
- Imperial strip\*

Structure	Steel support strip S.A.E 1010. Sintered Bronze layer. PTFE.
Static load	250 N/mm <sup>2</sup>
Dynamic load	140 N/mm <sup>2</sup>
Maximum sliding speed	2.5 m/s dry 5.0 m/s with oil
Operating temperature	-200°C to +280°C
Thermal conductivity	46 W/mK
Coefficient of friction	
W/MU Dry	0.02 to 0.20
W/MU Oiled	0.02 to 0.15
W/MLF Dry	0.04 to 0.30
W/MLF Oiled	0.02 to 0.10
Recommended housing tolerance	4.5mm/5.5mm H6 7.0mm/305mm H7
Recommended shaft tolerance	3.0mm/4.0mm h6 5.0mm/75mm f7 80mm/300mm h8
Recommended shaft finish	Ra ≤ 0.4um (N5)
Recommended shaft hardness	HB > 200

Structure	Steel support strip S.A.E 1010. Sintered Bronze layer. Co-Acetal polymer.
Static load	140 N/mm <sup>2</sup>
Dynamic load	70 N/mm <sup>2</sup>
Maximum sliding speed	2.5 m/s with grease
Operating temperature	-40°C to +110°C
Intermittent maximum temperature	130°C
Thermal conductivity	2W/mK
Coefficient of friction	0.05 to 0.12 with grease
Recommended housing tolerance	H7
Recommended shaft tolerance	h8
Recommended shaft finish	HB > 200
Recommended shaft hardness	HB > 200

### W/MUB Bronze Support Strip instead of Steel

Has greater resistance to corrosion than standard W/MU product.

Range, dimensions and tolerances are as standard W/MU product.

### Fitting Guidelines

1. Always use a fitting pin and fitting collar. See our fitting data sheet.
2. Lubricate back of bearing prior to assembly.
3. Chamfer lead in on housing to assist with assembly.



## WMX® Wrapped Imperial Plain. Acetal X Type

Reference	I.D. O.D.		Recommended Tolerances				Bearing Size when fitted		Oil hole	Standard Length Options (L)			
	Nominal		Housing		Shaft		Bore		Diameter	Tolerance +/- 0.010"			
	(inch)		(inch)				(inch)		(inch)	(inch)			
TFPI06TX x L	3/8	15/32	0.4694	0.4687	0.3648	0.3639	0.3694	0.3667	5/32	3/8	1/2	3/4	
TFPI07TX x L	7/16	17/32	0.5319	0.5312	0.4273	0.4263	0.4319	0.4292	5/32	1/2	3/4		
TFPI08TX x L	1/2	19/32	0.5944	0.5937	0.4897	0.4887	0.4944	0.4917	5/32	3/8	1/2	5/8	7/8
TFPI09TX x L	9/16	21/32	0.6569	0.6562	0.5522	0.5512	0.5569	0.5542	5/32	1/2	3/4		
TFPI10TX x L	5/8	23/32	0.7195	0.7187	0.6146	0.6136	0.6195	0.6167	5/32	1/2	3/8	3/4	7/8
TFPI11TX x L	11/16	25/32	0.7820	0.7812	0.6770	0.6760	0.6820	0.6792	5/32	7/8			
TFPI12TX x L	3/4	7/8	0.8758	0.8750	0.7390	0.7378	0.7444	0.7412	5/32	1/2	3/4	1	
TFPI14TX x L	7/8	1	1.0008	1.0000	0.8639	0.8627	0.8694	0.8662	1/4	3/4	7/8	1	
TFPI16TX x L	1	1 1/8	1.1258	1.1250	0.9888	0.9876	0.9944	0.9912	1/4	3/4	1	1 1/2	
TFPI18TX x L	1 1/8	1 9/32	1.2822	1.2812	1.1138	1.1126	1.1202	1.1164	1/4	3/4	1		
TFPI20TX x L	1 1/4	1 13/32	1.4072	1.4062	1.2387	1.2371	1.2452	1.2414	1/4	3/4	1	1 1/4	1 3/4
TFPI22TX x L	1 3/8	1 17/32	1.5322	1.5312	1.3635	1.3619	1.3702	1.3664	1/4	1	1 3/8	1 3/4	
TFPI24TX x L	1 1/2	1 21/32	1.6572	1.6562	1.4884	1.4868	1.4952	1.4914	5/16	1	1 1/4	1 1/2	2
TFPI26TX x L	1 5/8	1 25/32	1.7822	1.7812	1.6133	1.6117	1.6202	1.6164	5/16	1	1 1/2		
TFPI28TX x L	1 3/4	1 15/16	1.9385	1.9375	1.7393	1.7367	1.7461	1.7415	5/16	1	1 1/2	1 3/4	2
TFPI30TX x L	1 7/8	2 1/16	2.0637	2.0625	1.8632	1.8616	1.8713	1.8665	5/16	1	1 7/8	2 1/4	
TFPI32TX x L	2	2 1/16	2.1887	2.1875	1.9881	1.9863	1.9963	1.9915	5/16	1	1 1/2	2	2 1/2
TFPI36TX x L	2 1/4	2 7/16	2.4387	2.4375	2.2378	2.2360	2.2463	2.2415	5/16	2	2 1/4	2 1/2	
TFPI40TX x L	2 1/2	2 11/16	2.6887	2.6875	2.4875	2.4857	2.4963	2.4915	5/16	2	2 1/2		
TFPI44TX x L	2 3/4	2 15/16	2.9387	2.9395	2.7351	2.7333	2.7457	2.7393	5/16	2	2 1/2	3	3 1/2
TFPI48TX x L	3	3 3/16	3.1889	3.1875	3.9849	3.9831	2.9959	2.9893	3/8	2	3	3 3/4	
TFPI56TX x L	3 1/2	3 11/16	3.6889	3.6875	3.4844	3.4822	3.4959	3.4893	3/8	2 1/2	3	3 3/4	
TFPI64TX x L	4	4 3/16	4.1889	4.1872	4.9839	4.9817	3.9959	3.9893	3/8	3	3 3/4	4 3/4	

Non-standard lengths can be supplied. If the size you require is not listed please contact our sales dept. We also offer a specialised machining service for low volume non-standard sizes and tolerances.



### Lubricated Sliding Bearings



Oil or grease lubricated bearings. Carbon steel shell with sintered bronze layer with a co- acetal polymer layer. Available in metric and imperial sizes from stock.



### Dry Sliding Bearings



Self lubricated plain & flanged bearings & strip. Carbon steel shell with sintered bronze layer filled with PTFE. Available in metric and imperial sizes from stock. Also bronze shell versions can be supplied to order.

### White Metal Bearings



White metal bearings can be manufactured to order in various material grades.

### Plastic Bearings Moulded & Machined



Available in metric sizes from stock. Can also be manufactured in many different types of plastic material to suit various applications. Machined for small quantities and moulded for large quantities.

### Standard Wrapped Bearings



Oil or grease lubricated bearings. Carbon Steel shell with sintered bronze lining. Various metric and imperial sizes available from stock.



### Ball Bearings



Ball bearings in chrome or stainless steel. ABEC 1, 3 or 5. With or without seals. Various ranges available from stock.

### Machined Parts



Standard bearings modified. Custom shafts and bearings manufactured in cast bronze, plastic and other materials.

### Cast Bronze Bearings with Solid Graphite Lubrication



Various material specifications are offered. Standard and special shapes are available.



### Cast bronze bearings with solid graphite lubrication



**All these bearings are made to order. Other shapes can be offered.**

Graphite loaded bearings can withstand very high temperatures up to 425 °C (800 °F) as well as cryogenic temperatures down to -200°C (-400 °F) depending on the bronze material and graphite selected. This makes them ideal where conventional lubricants would carbonise. Please contact our technical department to ascertain which would be the most suitable combination to suit your application.

Typical applications are ovens, kilns, dryers, injection moulding machines, dust collectors, louvers and hot conveyors.

These bearings are also ideal in dry environments where contamination is undesirable. Typical applications would be printing, textile, and food machinery, as well as machines for making pills and cosmetic products.

They are also used extensively for wet applications where there is high humidity, or in submersed pumps, textile finishing machinery, lock gates, water turbines, chemical processing and plating applications.

This type of bearing is also useful where the bearings are in an inaccessible location, as they are lubricated for life.

#### Technical Data

Standard Material	Cu 65%, Zn 25%, Ai 6%, Mn 4%
Density	8 g/cm <sup>3</sup>
Hardness	> 210 HB
Tensile Strength	750 N/mm <sup>2</sup>
Elongation	> 12%
Linear Expansion	1.9 – 10 <sup>-5</sup> / °C
Max Temp	300 °C (570 °F)
Static Load	100 N/mm <sup>2</sup>
Max Speed	15 m/s
PV	200 N/mm <sup>2</sup> s m/s

Other cast bronze materials/specifications are available which can operate up to 425 °C.

Different shapes can be manufactured to suit customer requirements.

**OPTIBELT**  
**POWER TRANSMISSION**



# EXPECT MORE

...FROM YOUR BELT DRIVES

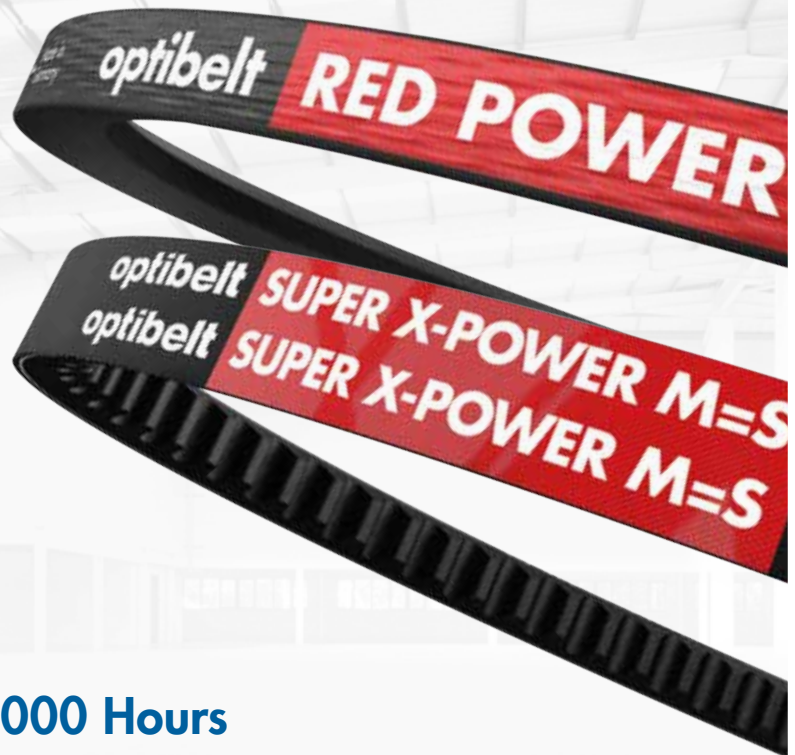

**25,000 Hours**

- Design life of our V-belts.  
That's  $\approx$  6 years! (14hr/6 day)

**Maintenance-Free**

- Our optibelt **RED POWER 3** belts

Optibelt (UK) • 01925 415777 • info@optibelt.co.uk • www.optibelt.com

**Optibelt** have been manufacturing transmission belts in Germany since 1948 and today are market leaders in belt technology. Our belts are made in our own European factories using in-house developed processes and advanced materials. The result is a range of belts which outperform other brands and deliver substantial cost savings and productivity improvements to our customers.



## OPTIBELT V-BELT PRODUCT RANGE

**25,000 hours design life** – That's  $\approx$  3 years running 24/7 or over 6 years running 12h/6d/wk. Optibelt V-belts are designed to outlast other brands. While 25,000 hours is a theoretical value assuming correct fitting and running conditions, it is a realistic and useful benchmark. Belt life significantly less than this indicates that improvements can be achieved.

Contact Optibelt via your local IADA branch for expert advice.



### **optibelt SK** – Premium quality, standard wrapped construction

High quality materials and advanced production processes result in a high performance, low stretch belt with extremely consistent properties allowing predictable and extended maintenance schedules with outstanding reliability and efficiency.

- **S=C Plus** precise length tolerance exceeds ISO set requirements so belts can be combined in sets without matching.



### **optibelt RED POWER 3** – Maintenance-free, Extra High Power

Special polyester tension cords combined with layers of transversely aligned fibre filled rubber give our **optibelt Red Power 3** belts truly maintenance-free properties. No re-tensioning is required throughout the life of the belt.

- **S=C Plus** precise length tolerance as with **optibelt SK**
- Up to 50% more power than standard **optibelt SK** belts – higher power or fewer belts.
- Direct, drop-in replacement for standard belts – no disadvantages or limitations.



### **optibelt SUPER X-POWER** – High performance Cogged Raw Edge belt

Our moulded cogged raw edge belts can transmit extremely high powers and are suitable for use with small pulley diameters on account of their flexible, cogged design making them particularly well suited for applications where space is limited.

- **M=S** process means that every belt is individually ground to precise length tolerance for use in sets without matching and smooth running.
- Extremely low stretch / Low maintenance



### **optibelt VB** – Premium quality, wrapped classical section V-belt

Classical profile V-belts to ISO 4184 / DIN 2215

- **S=C Plus** precise length tolerance exceeds ISO set requirements so belts can be combined in sets without matching.

	Temperature Range °C	Static Conductive to ISO 1813	Oil Resistance	Max. Belt Speed m/s	Profiles
<b>optibelt SK</b>	-40 / +70	Yes	Good	$\geq 42$	SPZ, SPA, SPB, SPC
<b>optibelt RED POWER 3</b>	-30 / +100	Yes	Good	$\geq 55$	SPZ, SPA, SPB, SPC
<b>optibelt SUPER X-POWER</b>	-30 / +90	Yes	Good	$\geq 55$	XPZ, XPA, XPB, XPC
<b>optibelt VB</b>	-40 / +70	Yes	Limited	$\geq 30$	5, 6, 8, Z, A, B, 20, C, 25, D, E

Our standard range of V-belts listed above are generally available from UK stock. Optibelt also manufacture a wide range of belts with special and high performance constructions for applications which require properties beyond those offered by standard belts.



## V-BELT TECHNICAL DATA

### Power ratings

BELT DRIVES

#### SPZ / XPZ

	Speed (rpm)	Datum diameter of small pulley (mm)						
		56	63	85	100	125	160	200
SK	700	-	0.5	1	1.33	1.88	2.63	3.47
	950	-	0.63	1.29	1.74	2.46	3.45	4.54
	1450	-	0.87	1.84	2.49	3.54	4.96	6.51
	2850	-	1.38	3.13	4.27	6.07	8.34	10.55
RP3	700	-	0.72	1.37	1.8	2.5	3.47	4.56
	950	-	0.92	1.78	2.35	3.29	4.56	5.99
	1450	-	1.3	2.56	3.4	4.75	6.6	8.63
	2850	-	2.16	4.44	5.93	8.28	11.29	14.26
S X-P	700	0.72	0.92	1.53	2.26	2.61	3.51	4.53
	950	0.92	1.18	1.98	2.94	3.39	4.58	5.9
	1450	1.27	1.65	2.83	4.22	4.87	6.58	8.44
	2850	2.07	2.76	4.86	7.3	8.42	11.26	14.17

#### SPA / XPA

	Speed (rpm)	Datum diameter of small pulley (mm)						
		71	90	100	125	160	200	250
SK	700	-	1.17	1.55	2.47	3.73	5.14	6.85
	950	-	1.49	1.98	3.2	4.86	6.7	8.92
	1450	-	2.04	2.76	4.53	6.92	9.52	12.58
	2850	-	3.14	4.4	7.43	11.25	14.97	18.43
RP3	700	-	1.61	2.08	3.24	4.84	6.64	8.82
	950	-	2.06	2.69	4.22	6.34	8.69	11.56
	1450	-	2.88	3.79	6.05	9.13	12.52	16.57
	2850	-	4.69	6.35	10.36	15.6	21.02	26.82
S X-P	700	1.12	1.78	2.48	3.63	5.22	7	9.18
	950	1.43	2.31	3.24	4.77	6.87	9.22	12.08
	1450	2.01	3.31	4.68	6.93	10	13.39	17.46
	2850	3.31	5.7	8.2	12.21	17.49	22.98	28.88

#### SPB / XPB

	Speed (rpm)	Datum diameter of small pulley (mm)						
		112	140	180	224	280	315	400
SK	700	-	3.46	5.77	8.26	11.33	13.21	17.59
	950	-	4.42	7.46	10.69	14.66	17.04	22.5
	1450	-	6.09	10.44	14.96	20.3	23.36	29.83
	2850	-	9.07	15.71	21.57	26.4	27.68	
RP3	700	-	4.82	7.8	11.02	15.02	17.48	23.33
	950	-	6.23	10.18	14.41	19.66	22.86	30.38
	1450	-	8.8	14.54	20.65	28.09	32.54	42.65
	2850	-	14.53	24.35	34.12	44.76	50.24	
S X-P	700	3.32	5.36	8.26	11.4	15.34	17.77	23.56
	950	4.38	7.12	10.98	15.16	20.36	23.54	31.02
	1450	6.41	10.49	16.18	22.25	29.65	34.07	44.02
	2850	11.36	18.67	28.4	37.94	47.97	52.8	

#### SPC / XPC

	Speed (rpm)	Datum diameter of small pulley (mm)						
		112	140	180	224	280	315	400
SK	700	-	10.46	16.13	19.58	27.68	36.64	47.28
	950	-	13.27	20.58	24.97	35.05	45.7	57.27
	1450	-	17.79	27.64	33.3	45.25	55.51	61.37
	2850	-	20.63	29.58	31.96	Belt speed $\geq$ 42m/s		
RP3	700	-	13.31	20.38	24.71	15.02	46.63	61.01
	950	-	17.08	26.33	31.97	19.66	59.86	77.33
	1450	-	23.68	36.76	44.57	28.09	80.51	99.23
	2850	-	34.84	53.33	62.76	Belt speed $\geq$ 42m/s		
S X-P	700	10.79	15.29	20.94	24.43	32.74	42.18	53.82
	950	14.4	20.39	27.86	32.42	43.16	55.01	68.91
	1450	21.27	29.98	40.6	46.91	61.06	75.11	88.17
	2850	37.09	50.58	64.43	70.83	Belt speed $\geq$ 42m/s		

Note: Power ratings are for rough guidance only. Service and other design factors should be taken into consideration. Consult Optibelt technical catalogue or Drive design software for more info.

#### SERVICE FACTORS

Type of machine driver >	„Soft start“ motors with starting torque $\leq$ 1.8* nominal. Engines with > 4 cylinders	Motors with hard / high torque start > 1.8* nominal torque. Engines with <4 cylinders.					
Type of Application	Daily Operating Hours			Daily Operating Hours			
	< 10	10-16	> 16	< 10	10-16	> 16	
Light Duty	1.1	1.1	1.2	1.1	1.2	1.3	
Medium Duty	1.1	1.2	1.3	1.2	1.3	1.4	
Heavy Duty	1.2	1.3	1.4	1.4	1.5	1.6	
Very Heavy Duty	1.3	1.4	1.5	1.5	1.6	1.8	

#### BELT LENGTH CONVERSION FACTORS

Profile	$L_d \rightarrow L_i$	$L_d \rightarrow L_o$	Profile	$L_d \rightarrow L_i$	$L_d \rightarrow L_o$
SPZ / XPZ	- 38	+ 13	Z / ZX	- 22	+ 16
SPA / XPA	- 45	+ 18	A / AX	- 30	+ 20
SPB / XPB	- 60	+ 22	B / BX	- 40	+ 29
SPC / XPC	- 83	+ 30	C / CX	- 58	+ 30

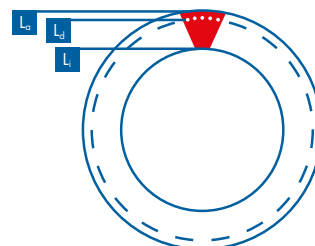

## OPTIBELT WEDGE BELTS

### optibelt RED POWER 3



Maintenance Free  
Up to 50% more power  
Up to 97% efficient  
Precision length tolerance  
Available from  
SPZ 1202 – SPC 10000

### optibelt SK



Premium quality as standard  
Precise length tolerance  
Up to 97% efficient

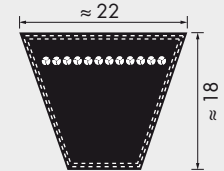
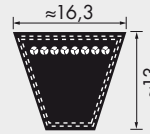
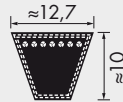
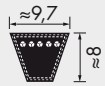

SPZ			SPA			SPB		SPC	
Min. Rec. Pulley Ø = 63 mm			Min. Rec. Pulley Ø = 90 mm			Min. Rec. Pulley Ø = 140 mm		Min. Rec. Pulley Ø = 224 mm	
487	1112	1837	732	1482	2360	1250	4250	2000	
512	1120	1850	757	1500	2382	1320	4300	2120	
562	1137	1862	782	1507	2432	1400	4500	2240	
587	1162	1887	800	1532	2482	1450	4560	2360	
612	1180	1900	807	1557	2500	1500	4750	2500	
630	1187	1937	832	1582	2532	1600	4820	2650	
637	1202	1987	850	1600	2582	1700	5000	2800	
662	1212	2000	857	1607	2607	1750	5070	3000	
670	1237	2037	882	1632	2632	1800	5300	3150	
687	1250	2120	900	1657	2650	1850	5600	3350	
710	1262	2137	907	1682	2682	1900	6000	3550	
722	1287	2150	932	1700	2732	2000	6300	3750	
737	1312	2187	950	1707	2782	2020	6700	4000	
750	1320	2240	957	1732	2800	2060	7100	4250	
762	1337	2287	982	1757	2832	2120	7500	4500	
772	1347	2360	1000	1782	2847	2150	8000	4750	
787	1362	2500	1007	1800	2882	2180		5000	
800	1387	2540	1032	1807	2932	2240		5300	
812	1400	2650	1060	1832	2982	2280		5600	
825	1412	2690	1082	1857	3000	2360		6000	
837	1437	2800	1107	1882	3032	2391		6300	
850	1462	2840	1120	1900	3082	2400		6700	
862	1487	3000	1132	1907	3150	2500		7100	
875	1500	3150	1157	1932	3182	2650		7500	
887	1512	3350	1180	1957	3282	2680		8000	
900	1537	3550	1207	1982	3350	2800		8500	
912	1562		1232	2000	3382	2840		9000	
925	1587		1250	2032	3550	2850		9500	
937	1600		1257	2057	3750	2900		10000	
950	1612		1272	2082	4000	3000		10600	
962	1637		1282	2120	4250	3150		11200	
987	1650		1307	2132	4500	3250		12500	
1000	1662		1320	2182		3350			
1012	1687		1332	2207		3450			
1024	1700		1357	2232		3550			
1037	1737		1382	2240		3650			
1047	1762		1400	2282		3750			
1060	1787		1407	2300		3800			
1077	1800		1432	2307		4000			
1087	1812		1457	2332		4050			

#### OPTIBELT PULLEYS AVAILABLE TO SUIT

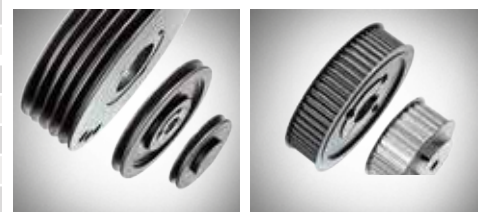

Intermediate and longer lengths available  
Also available in American standard 3V/5V/8V

## OPTIBELT RAW EDGE COGGED BELTS

### optibelt SUPER X-POWER M=S

BELT DRIVES

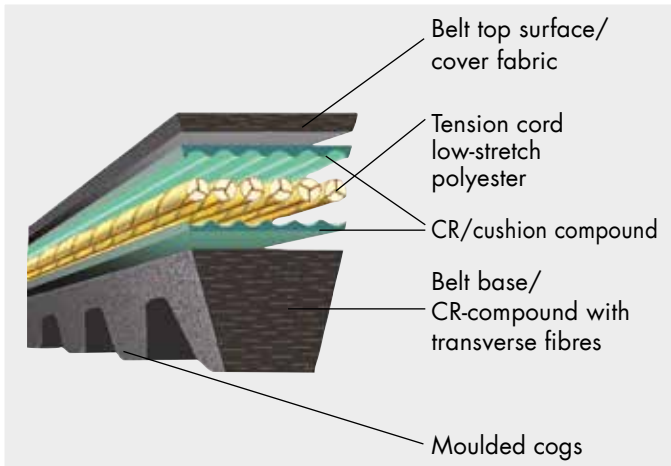

Ideal for very high power drives  
 Cogging allows very small pulley diameters  
 Individually ground flanks for precise length tolerance and smooth running.  
 Very low stretch / low maintenance  
 High temperature to 90°  
 Specify SUPER E-POWER for extreme temperatures (-50°C to +120°C)

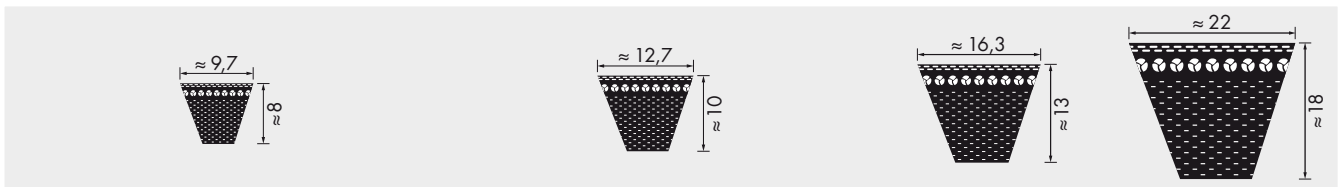

XPZ			XPA			XPB	XPC
Min. Rec. Pulley Ø = 56 mm			Min. Rec. Pulley Ø = 71 mm			Min. Rec. Pulley Ø = 112 mm	Min. Rec. Pulley Ø = 180 mm
587	1012	1562	707	1272	1882	1250	2000
612	1037	1587	732	1282	1900	1320	2120
630	1060	1600	757	1307	1932	1400	2240
637	1077	1612	782	1320	1950	1500	2360
662	1087	1662	800	1332	1982	1600	2500
670	1112	1700	807	1357	2000	1700	2650
687	1120	1750	832	1382	2120	1750	2800
710	1137	1762	850	1400	2240	1800	3000
730	1162	1800	857	1432	2360	1850	3150
737	1180	1850	882	1450	2500	1900	3350
750	1187	1900	900	1457	2650	2000	3550
762	1202	1950	907	1482	2800	2020	
772	1212	2000	932	1500	3000	2120	
787	1237	2120	950	1507	3150	2150	
800	1250	2150	957	1532	3350	2240	
812	1262	2240	982	1557	3550	2280	
825	1287	2360	1000	1582		2360	
837	1312	2500	1007	1600		2400	
850	1320	2540	1030	1607		2500	
862	1337	2650	1060	1632		2650	
875	1362	2690	1082	1650		2680	
887	1387	2800	1107	1682		2800	
900	1400	2840	1120	1700		2840	
912	1412	3000	1132	1732		3000	
925	1437	3150	1157	1750		3150	
937	1462	3350	1180	1757		3350	
950	1487	3550	1207	1782		3550	
962	1500		1232	1800			
987	1512		1250	1832			
1000	1537		1257	1850			

Also available in American standard 3VX, 5VX  
 optibelt SUPER TX Classical profiles available ZX, AX, BX, CX

# OPTIBELT CLASSICAL V-BELTS

optibelt **VB**

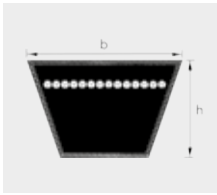

Profile	Z	A	B	C
b [mm]	10	13	17	22
h [mm]	6	8	11	14

BELT DRIVES

Premium quality as standard for reliability and long life.  
Precision length tolerance means no matching required – \*within indicated S=C Plus range.

Z/10									A/13								
Min. Rec. Pulley Ø = 50 mm									Min. Rec. Pulley Ø = 71 mm								
Belt No.	Datum length L <sub>d</sub>	Inside length L <sub>i</sub>	Belt No.	Datum length L <sub>d</sub>	Inside length L <sub>i</sub>	Belt No.	Datum length L <sub>d</sub>	Inside length L <sub>i</sub>	Belt No.	Datum length L <sub>d</sub>	Inside length L <sub>i</sub>	Belt No.	Datum length L <sub>d</sub>	Inside length L <sub>i</sub>	Belt No.	Datum length L <sub>d</sub>	Inside length L <sub>i</sub>
Z 11	312	290	Z 38½	997	975	Z 68	1747	1725	A 16	437	407	A 46½	1210	1180	A 87	2240	2210
Z 12½	337	315	Z 39	1022	1000	Z 69	1772	1750	A 18	487	457	A 47	1230	1200	A 88	2270	2240
Z 14	397	375	Z 40	1038	1016	Z 70	1797	1775	A 19	510	480	A 47½	1245	1215	A 89	2291	2261
Z 15	422	400	Z 40½	1052	1030	Z 71	1822	1800	A 20	538	508	A 48	1250	1220	A 90	2316	2286
Z 16	447	425	Z 41	1063	1041	Z 73	1872	1850	A 21	565	535	A 48½	1255	1225	A 91	2341	2311
Z 17	472	450	Z 41½	1072	1050	Z 75	1922	1900	A 22	590	560	A 49	1280	1250	A 92	2367	2337
Z 18	497	475	Z 42	1082	1060	Z 78	1997	1975	A 23	605	575	A 50	1300	1270	A 93	2390	2360
Z 19	502	480	Z 43	1102	1080	Z 79	2022	2000	A 23½	630	600	A 51	1330	1300	A 94	2418	2388
Z 19¾	522	500	Z 43¼	1122	1100	Z 83½	2142	2120	A 24	640	610	A 52	1350	1320	A 95	2443	2413
Z 20	537	515	Z 44	1142	1120	Z 88	2262	2240	A 25	660	630	A 53	1380	1350	A 96	2468	2438
Z 20½	547	525	Z 45	1172	1150	Z 93	2382	2360	A 26	680	650	A 54	1405	1375	A 97	2494	2464
Z 21	552	530	Z 46	1187	1165	Z 98	2522	2500	A 26½	700	670	A 55	1430	1400	A 98	2530	2500
Z 21¼	562	540	Z 46½	1202	1180				A 27	716	686	A 56	1452	1422	A 100	2570	2540
Z 22	582	560	Z 47	1216	1194				A 27½	730	700	A 57	1480	1450	A 102	2621	2591
Z 23	597	575	Z 48	1237	1215				A 28	740	710	A 58	1505	1475	A 104	2680	2650
Z 24	622	600	Z 48½	1247	1225				A 29	760	730	A 59	1530	1500	A 105	2697	2667
Z 25	652	630	Z 49	1272	1250				A 29½	780	750	A 60	1555	1525	A 107	2755	2725
Z 26	672	650	Z 50	1292	1270				A 30	797	767	A 61	1580	1550	A 108	2773	2743
Z 27	692	670	Z 51	1317	1295				A 31	805	775	A 62	1605	1575	A 110	2830	2800
Z 27½	722	700	Z 52	1342	1320				A 31½	830	800	A 63	1630	1600	A 112	2875	2845
Z 28	732	710	Z 53	1368	1346				A 32	843	813	A 64	1655	1625	A 114	2926	2896
Z 28½	747	725	Z 54	1393	1371				A 32½	855	825	A 65	1680	1650	A 116	2976	2946
Z 29	752	730	Z 55	1422	1400				A 33	871	841	A 66	1706	1676	A 118	3030	3000
Z 29½	772	750	Z 56	1444	1422				A 34	880	850	A 67	1730	1700	A 120	3078	3048
Z 30	787	765	Z 57	1472	1450				A 34½	905	875	A 68	1755	1725	A 124	3180	3150
Z 31	797	775	Z 58	1497	1475				A 35	919	889	A 69	1780	1750	A 128	3280	3250
Z 31½	822	800	Z 59	1522	1500				A 35½	930	900	A 70	1805	1775	A 132	3380	3350
Z 32	842	820	Z 60	1546	1524				A 36	944	914	A 71	1830	1800	A 136	3484	3454
Z 33	847	825	Z 61	1572	1550				A 37	955	925	A 72	1855	1825	A 140	3580	3550
Z 33½	872	850	Z 62	1597	1575				A 37½	980	950	A 73	1884	1854	A 144	3688	3658
Z 34	887	865	Z 63	1622	1600				A 38	995	965	A 74	1910	1880	A 148	3780	3750
Z 35	897	875	Z 64	1648	1626				A 38½	1005	975	A 75	1930	1900	A 158	4030	4000
Z 36	922	900	Z 65	1673	1651				A 39	1030	1000	A 76	1960	1930	A 167	4280	4250
Z 37	947	925	Z 66	1697	1675				A 40	1046	1016	A 77	1986	1956	A 187	4780	4750
Z 38	972	950	Z 67	1722	1700				A 40½	1060	1030	A 78	2010	1980	A 197	5030	5000
									A 41	1071	1041	A 79	2030	2000			
									A 41½	1080	1050	A 80	2062	2032			
									A 42	1090	1060	A 81	2090	2060			
									A 42½	1105	1075	A 82	2113	2083			
									A 43	1130	1100	A 83	2130	2100			
									A 43½	1135	1105	A 83½	2150	2120			
									A 44	1150	1120	A 84	2164	2134			
									A 45	1173	1143	A 84½	2180	2150			
									A 45½	1180	1150	A 85	2190	2160			
									A 46	1198	1168	A 86½	2230	2200			

Also available in sections 5/6/8/20/25/D/E – see Optibelt catalogue for details



## OPTIBELT LAWMOWER BELTS

### optibelt GREEN GARDEN



As one of Europe's leading suppliers of belts to mower original equipment manufacturers, Optibelt know what it takes to make a good mower belt. **optibelt GREEN GARDEN** belts are designed to give outstanding performance on the toughest mower applications.

- Standard 3L, 4L, 5L sections with aramid tension cords for resistance to high shock loading with tough, semi-friction outer cover to cope with clutching applications.
- Double sided AA/HAA belts with aramid cords

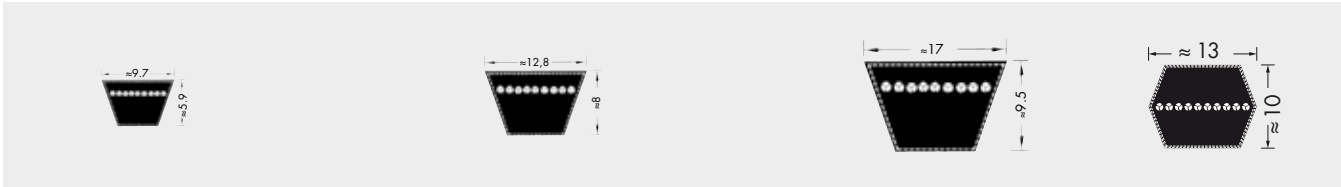

3L	4L	5L	AA / HAA	
3L 160 / 406 La	4L 180 / 457 La	4L 620 / 1575 La	5L 350 / 889 La	HAA 71 / 1856 Lb
3L 170 / 432 La	4L 200 / 508 La	4L 630 / 1600 La	5L 490 / 1245 La	HAA 72 / 1882 Lb
3L 180 / 457 La	4L 210 / 533 La	4L 640 / 1626 La	5L 500 / 1270 La	HAA 73 / 1907 Lb
3L 190 / 483 La	4L 220 / 559 La	4L 650 / 1651 La	5L 510 / 1295 La	HAA 74 / 1933 Lb
3L 200 / 508 La	4L 230 / 584 La	4L 660 / 1676 La	5L 520 / 1321 La	HAA 75 / 1958 Lb
3L 210 / 533 La	4L 240 / 610 La	4L 670 / 1702 La	5L 530 / 1346 La	HAA 77 / 2007 Lb
3L 220 / 559 La	4L 250 / 635 La	4L 680 / 1727 La	5L 540 / 1372 La	HAA 78 / 2034 Lb
3L 230 / 584 La	4L 260 / 660 La	4L 690 / 1753 La	5L 550 / 1397 La	HAA 80 / 2085 Lb
3L 240 / 610 La	4L 270 / 686 La	4L 700 / 1778 La	5L 560 / 1422 La	HAA 81 / 2108 Lb
3L 250 / 635 La	4L 280 / 711 La	4L 710 / 1803 La	5L 570 / 1448 La	HAA 82 / 2136 Lb
3L 260 / 660 La	4L 290 / 737 La	4L 720 / 1829 La	5L 580 / 1473 La	HAA 83 / 2161 Lb
3L 270 / 686 La	4L 300 / 762 La	4L 730 / 1854 La	5L 590 / 1499 La	HAA 85 / 2212 Lb
3L 280 / 711 La	4L 310 / 787 La	4L 740 / 1880 La	5L 600 / 1524 La	HAA 86 / 2237 Lb
3L 290 / 737 La	4L 320 / 813 La	4L 750 / 1905 La	5L 610 / 1549 La	HAA 88 / 2288 Lb
3L 300 / 762 La	4L 330 / 838 La	4L 760 / 1930 La	5L 620 / 1575 La	HAA 89 / 2311 Lb
3L 310 / 787 La	4L 340 / 864 La	4L 770 / 1956 La	5L 630 / 1600 La	HAA 90 / 2339 Lb
3L 320 / 813 La	4L 350 / 889 La	4L 780 / 1981 La	5L 640 / 1626 La	HAA 91 / 2364 Lb
3L 330 / 813 La	4L 360 / 914 La	4L 790 / 2007 La	5L 650 / 1651 La	HAA 92 / 2390 Lb
3L 340 / 864 La	4L 370 / 940 La	4L 800 / 2032 La	5L 660 / 1676 La	HAA 93 / 2415 Lb
3L 350 / 889 La	4L 380 / 965 La	4L 810 / 2057 La	5L 670 / 1702 La	HAA 94 / 2441 Lb
3L 360 / 914 La	4L 390 / 991 La	4L 820 / 2083 La	5L 680 / 1727 La	HAA 95 / 2466 Lb
3L 370 / 940 La	4L 400 / 1016 La	4L 830 / 2108 La	5L 690 / 1753 La	HAA 96 / 2491 Lb
3L 380 / 965 La	4L 410 / 1041 La	4L 840 / 2134 La	5L 700 / 1778 La	HAA 98 / 2542 Lb
3L 390 / 991 La	4L 420 / 1067 La	4L 850 / 2159 La	5L 710 / 1803 La	HAA 99 / 2568 Lb
3L 400 / 1016 La	4L 430 / 1092 La	4L 860 / 2184 La	5L 720 / 1829 La	HAA 102 / 2644 Lb
3L 410 / 1041 La	4L 440 / 1118 La	4L 870 / 2210 La	5L 730 / 1854 La	HAA 105 / 2720 Lb
3L 420 / 1067 La	4L 450 / 1143 La	4L 880 / 2235 La	5L 740 / 1880 La	HAA 108 / 2796 Lb
3L 430 / 1092 La	4L 460 / 1168 La	4L 890 / 2261 La	5L 750 / 1905 La	HAA 110 / 2847 Lb
3L 440 / 1118 La	4L 470 / 1194 La	4L 900 / 2286 La	5L 760 / 1930 La	HAA 112 / 2898 Lb
3L 450 / 1143 La	4L 480 / 1219 La	4L 910 / 3211 La	5L 770 / 1956 La	HAA 116 / 2997 Lb
3L 460 / 1168 La	4L 490 / 1245 La	4L 920 / 2337 La	5L 780 / 1981 La	HAA 120 / 3101 Lb
3L 470 / 1194 La	4L 500 / 1270 La	4L 930 / 2362 La	5L 790 / 2007 La	HAA 121 / 3126 Lb
3L 480 / 1219 La	4L 510 / 1295 La	4L 940 / 2388 La	5L 800 / 2032 La	HAA 123 / 3175 Lb
3L 490 / 1245 La	4L 520 / 1321 La	4L 950 / 2413 La	5L 810 / 2057 La	HAA 126 / 3251 Lb
3L 500 / 1270 La	4L 530 / 1346 La	4L 960 / 2438 La	5L 820 / 2083 La	HAA 128 / 3304 Lb
3L 520 / 1321 La	4L 540 / 1372 La	4L 970 / 2464 La		HAA 129 / 3327 Lb
	4L 550 / 1397 La	4L 980 / 2489 La		HAA 134 / 3454 Lb
	4L 560 / 1422 La	4L 990 / 2515 La		HAA 136 / 3505 Lb
	4L 570 / 1448 La	4L 1000 / 2540 La		HAA 144 / 3708 Lb
	4L 580 / 1473 La	4L 1030 / 2616 La		HAA 150 / 3861 Lb
	4L 590 / 1499 La	4L 1100 / 2794 La		HAA 161 / 4140 Lb
	4L 600 / 1524 La	4L 1120 / 2845 La		HAA 178 / 4572 Lb
	4L 610 / 1549 La	4L 1170 / 2972 La		HAA 183 / 4699 Lb

In addition to the standard range of profiles listed above, Optibelt offer an extensive cross reference of OE equivalent mower belts of all types.

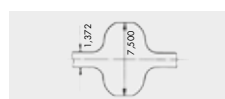

Double sided timing belts are also in the Green Garden range e.g. DS8M 1800 200

## OPTIBELT VARIABLE SPEED BELTS

### optibelt VARIO POWER

BELT DRIVES

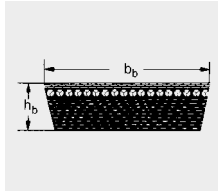

Ordering example :

13x5 468 :

13mm  $b_b$  x 5mm  $h_b$  x 468mm  $L_i$  (inside length)

optibelt VARIO POWER variable speed belts are manufactured in raw edge, cogged construction as standard.

A wide range of sizes available from UK stock.

Additional constructions and profiles including wrapped, double sided and American standard available to order.

Description $L_i$	Description $L_w$	Description $L_i$	Description $L_w$	Description $L_i$	Description $L_w$	Description $L_i$	Description $L_w$
<b>DIN/ISO</b>		26X8 962	W 25 1000	32X10 950	W 31.5 1000	47X13 1060	-
13x5 468	-	26X8 1082	W 25 1120	32X10 1000	W 31.5 1050	47X13 1120	-
13x5 500	-	28X8 600	-	32X10 1073	W 31.5 1120	47X13 1180	-
17x5 426	W 16 450	28X8 650	-	32X10 1120	W 31.5 1170	47X13 1250	-
17x5 476	W 16 500	28X8 700	-	32X10 1180	W 31.5 1230	47X13 1320	-
17x5 536	W 16 560	28X8 750	-	32X10 1200	W 31.5 1250	47X13 1400	-
17x5 570	W 16 600	28X8 800	-	32X10 1353	W 31.5 1400	47X13 1500	-
17x5 606	W 16 630	28X8 850	-	37X10 660	-	47X13 1600	-
17x5 776	W 16 800	28X8 900	-	37X10 800	-	47X13 1700	-
21X6 530	W 20 560	28X8 950	-	37X10 850	-	47X13 1800	-
21X6 600	W 20 630	28X8 1000	-	37X10 900	-	52X16 1180	W 50 1250
21X6 610	W 20 640	28X8 1060	-	37X10 950	-	52X16 1250	W 50 1320
21X6 675	W 20 710	28X8 1120	-	37X10 1000	-	52X16 1325	W 50 1400
21X6 770	W 20 800	28X8 1180	-	37X10 1020	-	52X16 1400	W 50 1480
21X6 870	W 20 900	28X8 1250	-	37X10 1060	-	52X16 1525	W 50 1600
21X6 970	W 20 1000	28X8 1320	-	37X10 1120	-	52X16 1600	W 50 1680
21X6 1220	W 20 1250	28X8 1400	-	37X10 1180	-	52X16 1725	W 50 1800
22X8 485	-	28X8 1500	-	37X10 1250	-	52X16 1925	W 50 2000
22X8 525	-	30X10 650	-	37X10 1320	-	52X16 2165	W 50 2240
22X8 565	-	30X10 665	-	37X10 1400	-	52X16 2240	W 50 2320
22X8 610	-	30X10 700	-	37X10 1500	-	55X16 1400	-
22X8 650	-	30X10 800	-	37X10 1600	-	55X16 1500	-
22X8 700	-	30X10 850	-	37X10 1700	-	55X16 1600	-
22X8 750	-	30X10 875	-	37X10 1800	-	55X16 1700	-
22X8 800	-	30X10 900	-	41X13 925	W 40 990	55X16 1800	-
22X8 850	-	30X10 950	-	41X13 1000	W 40 1060	65X20 1706	W 63 1800
22X8 900	-	30X10 1000	-	41X13 1040	W 40 1100	65X20 1906	W 63 2000
22X8 950	-	30X10 1035	-	41X13 1060	W 40 1120	70X18 1600	-
22X8 1000	-	30X10 1120	-	41X13 1120	W 40 1180	70X18 1700	-
22X8 1060	-	30X10 1200	-	41X13 1180	W 40 1240	70X18 1800	-
22X8 1185	-	30X10 1340	-	41X13 1190	W 40 1250	70X18 1900	-
26X8 655	W 25 690	30X10 1500	-	41X13 1250	W 40 1310	70X18 2000	-
26X8 672	W 25 710	30X10 1600	-	41X13 1340	W 40 1400	70X18 2240	-
26X8 710	W 25 750	32X10 750	W 31.5 800	41X13 1440	W 40 1500	70X18 2500	-
26X8 750	W 25 762	32X10 790	W 31.5 840	41X13 1600	W 40 1660		
26X8 762	W 25 800	32X10 820	W 31.5 870	41X13 1740	W 40 1800		
26X8 800	W 25 840	32X10 850	W 31.5 900	41X13 1940	W 40 2000		
26X8 862	W 25 900	32X10 900	W 31.5 950	47X13 1000	-		

## OPTIBELT TIMING BELT PRODUCT RANGE POWER TRANSMISSION

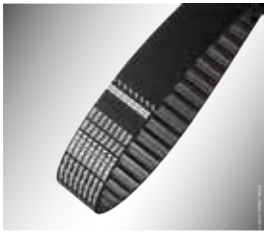

### optibelt **OMEGA** – Premium quality, metric pitch timing belt for HTD / RPP pulleys

High quality chloroprene rubber with glass fibre tension cords. Ideal for general power transmission applications. Omega belts are quiet running and up to 98% efficient.

- Available in pitch 3M, 5M, 8M, 14M & Double Sided D5M, D8M, D14M

The Omega tooth profile is designed to run perfectly in both standard HTD and RPP pulleys. The small dent in the tip of the tooth allows air to escape easily resulting in a quieter running belt.



### optibelt **OMEGA HP** – High Power

A special aramid fibre filled rubber compound and cover fabric gives the teeth far greater shear strength and dimensional stability allowing

**optibelt OMEGA HP** to transmit up to 2.5-3 X more power than standard

HTD belts while using the same pulleys.

Available in pitch (2MHP MTO), 3MHP, 5MHP, 8MHP, 14MHP & Double sided D8MHP

### COST ADVANTAGE

Due to its far higher power rating, **optibelt OMEGA HP** can significantly reduce the size and purchase cost of a drive. The table opposite compare three drives transmitting the same power with similar service factors.

Width is reduced from 3 inches (76 mm) to 30mm and cost is reduced by 63% V's a classical H pitch and 52% V's a standard 8M belt.

	Classical	8M	8MHP
Belt	400-H-300	1040-8M-50	920-8MHP-30
Pulley 1	TB-21-H-300	TB 34-8M-50	TB-24-8M-30
Pulley 2	TB-30-H-300	TB-48-8M-50	TB-34-8M-30
Total Cost	100%	77%	37%
<b>Saving</b>		<b>23%</b>	<b>63% / 52%</b>



### optibelt **ZR** – Classical timing belts

High quality chloroprene rubber compound with glass fibre reinforcing cords. Classical timing belts have mostly been superseded by modern, higher power belts such as **optibelt OMEGA** and **optibelt DELTA CHAIN Carbon** but are still widely used on older applications.

Available in classical tooth pitches MXL, XL, L, H, XH, XXH and double sided DXL, DL, DH



### optibelt **DELTA CHAIN Carbon** – High Performance Timing Belts

Tough polyurethane teeth with Carbon fibre tension cords allow exceptionally high power and torque transmission with a relatively narrow belt. Up to 100% more power than even

**optibelt OMEGA HP**. **optibelt DELTA CHAIN Carbon** is also particularly well suited to low speed, high torque applications making it a credible, clean and maintenance-free alternative to roller chain in many applications.

Our standard range of timing belts for transmission applications listed above are generally available from UK stock.

Optibelt also manufacture a wide range of other timing belts including belts with special and high performance constructions.



### optibelt **STD / STD HP**

Constructions similar to Omega/Omega HP but with tooth profile to suit STD pulleys.

Available in profiles: S5M, S8M, S14M, DS8M



### optibelt **OMEGA FAN POWER**

High performance belt tailored to Fin-Fan applications common in the petrochemical industry.

Anti-static to ISO 9563  
Available profiles 8MFP, 14MFP



### optibelt **OMEGA HL**

Extra heavy duty glass tension cords for improved resistance to shock loading.  
Available profiles :8MHL, 14MHL

### Special properties – made to order

- High temp ≤ 140°C
- Low temp ≥ -40°C
- Extra abrasion resistance
- Extra oil resistance
- Aramid cord
- Directional tracking
- Special tolerances



## OPTIBELT TIMING BELTS

### optibelt OMEGA / optibelt OMEGA HP

BELT DRIVES



Exceptional reliability and consistency  
Runs perfectly in both standard HTD® & RPP® Pulleys  
Unique low noise tooth profile  
Up to 98% efficient

**optibelt OMEGA HP** – High Performance, allows up to 2.5X power on standard pulleys  
Also available in selected sizes 8M & 14M:

**optibelt OMEGA HL** – for high shock load applications

**optibelt OMEGA FAN POWER** – Ultra high performance for fan drives in the petro/Chem industry

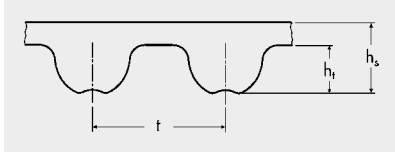

Section	2M	3M	5M	8M	14M
Tooth height ht [mm]	0.70	1.10	1.90	3.20	5.60
Total belt thickness hs [mm]	1.30	2.30	3.40	5.40	9.50
Tooth pitch t [mm]	2.00	3.00	5.00	8.00	14.00

3M				5M			
Pitch Length (mm)	No. Teeth	Pitch Length (mm)	No. Teeth	Pitch Length (mm)	No. Teeth	Pitch Length (mm)	No. Teeth
111	37	384	128	180	36	700	140
129	43	390	130	225	45	710	142
141	47	420	140	255	51	720	144
144	48	426	142	265	53	740	148
150	50	435	145	270	54	750	150
159	53	447	149	280	56	755	151
165	55	462	154	295	59	775	155
168	56	474	158	300	60	790	158
171	57	480	160	305	61	800	160
174	58	486	162	325	65	825	165
177	59	495	165	330	66	830	166
180	60	501	167	340	68	835	167
183	61	513	171	350	70	850	170
186	62	519	173	360	72	860	172
192	64	522	174	365	73	890	178
195	65	525	175	370	74	900	180
201	67	531	177	375	75	925	185
204	68	537	179	385	77	935	187
207	69	558	186	400	80	940	188
210	70	564	188	415	83	950	190
213	71	570	190	420	84	965	193
225	75	582	194	425	85	975	195
240	80	597	199	450	90	980	196
246	82	600	200	460	92	1000	200
249	83	606	202	475	95	1025	205
252	84	615	205	490	98	1035	207
255	85	633	211	500	100	1050	210
267	89	669	223	520	104	1100	220
276	92	675	225	525	105	1125	225
282	94	711	237	535	107	1135	227
285	95	738	246	540	108	1200	240
288	96	804	268	550	110	1270	254
291	97	816	272	560	112	1380	276
294	98	843	281	565	113	1400	280
300	100	882	294	575	115	1420	284
312	104	888	296	580	116	1425	285
315	105	1062	354	600	120	1500	300
318	106	1569	523	610	122	1595	319
330	110	1692	564	615	123	1690	338
333	111			630	126	1790	358
339	113			635	127	1870	374
345	115			640	128	1895	379
357	119			645	129	2000	400
363	121			650	130	2110	422
366	122			665	133	2350	470
				670	134	2525	505

## OPTIBELT TIMING BELTS

### optibelt **OMEGA** / optibelt **OMEGA HP**

8M				14M			
Pitch Length (mm)	No. Teeth	Pitch Length (mm)	No. Teeth	Pitch Length (mm)	No. Teeth	Pitch Length (mm)	No. Teeth
288	36	1224	153	966	69	2450	175
352	44	1248	156	1092	78	2590	185
376	47	1256	157	1190	85	2800	200
416	52	1264	158	1344	96	3150	225
424	53	1280	160	1400	100	3360	240
480	60	1304	163	1456	104	3500	250
512	64	1328	166	1512	108	3850	275
520	65	1344	168	1610	115	4326	309
560	70	1360	170	1680	120	4578	327
576	72	1400	175	1778	127		
600	75	1424	178	1890	135		
608	76	1440	180	2100	150		
624	78	1520	190	2310	165		
632	79	1552	194				
640	80	1584	198				
656	82	1600	200				
680	85	1680	210				
712	89	1696	212				
720	90	1728	216				
760	95	1760	220				
776	97	1800	225				
784	98	1904	238				
800	100	1936	242				
824	103	2000	250				
840	105	2080	260				
848	106	2104	263				
856	107	2240	280				
880	110	2248	281				
896	112	2272	284				
912	114	2400	300				
920	115	2504	313				
960	120	2600	325				
976	122	2800	350				
1000	125	3280	410				
1040	130						
1056	132						
1064	133						
1080	135						
1096	137						
1120	140						
1128	141						
1160	145						
1184	148						
1200	150						
1216	152						

#### OPTIBELT PULLEYS AVAILABLE TO SUIT

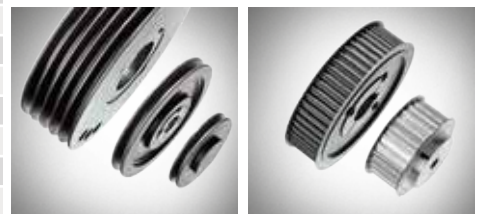

#### OTHER PROFILES

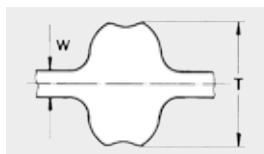

Double Sided in pitches  
D5M, D8M, D14M, DS8M

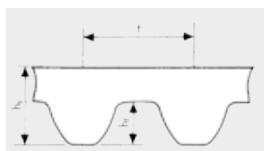

STD® Profile in pitches  
S3M, S5M, S8M, S14M  
Also in High Power  
OMEGA HP  
(S5MHP, S8MHP)

#### OPEN ENDED LENGTHS



Supplied in 30m rolls or cut to length.

Available in sizes:

3M in Widths 6, 9, 15, 20 mm

5M in Widths 6, 9, 10, 15, 20, 25, 30 mm

8M in Widths 10, 15, 20, 25, 30 mm

High Power Omega HP version  
available on request

## OPTIBELT CLASSICAL TIMING BELTS

optibelt ZR

BELT DRIVES

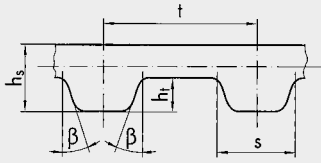

Section	MXL	XL	L	H	XH	XXH
Total belt thickness $h_s$ [mm]	1.14	2.30	3.60	4.30	11.20	15.70
Tooth pitch $t$ [mm]	2.032	5.08	9.525	12.70	22.225	31.75
Tooth height $h_t$ [mm]	0.51	1.27	1.91	2.29	6.35	9.53

MXL				XL			
Pitch Length (mm)	No. Teeth	Pitch Length (mm)	No. Teeth	Pitch Length (mm)	No. Teeth	Pitch Length (mm)	No. Teeth
67.06	33	274.32	135	152.40	30	584.20	115
91.44	45	282.45	139	177.80	35	609.60	120
109.73	54	284.48	140	203.20	40	619.76	122
111.76	55	288.54	142	218.44	43	629.92	124
113.79	56	298.70	147	223.52	44	635.00	125
115.82	57	300.74	148	228.60	45	660.40	130
117.86	58	304.80	150	233.68	46	685.80	135
121.92	60	310.90	153	238.76	47	690.88	136
123.95	61	323.09	159	243.84	48	695.96	137
136.14	67	325.12	160	248.92	49	711.20	140
138.18	68	335.28	165	254.00	50	726.44	143
142.24	70	345.44	170	259.08	51	736.60	145
144.27	71	355.60	175	269.24	53	751.84	148
146.30	72	365.76	180	274.32	54	762.00	150
152.40	75	373.89	184	279.40	55	777.24	153
154.43	76	386.08	190	284.48	56	787.40	155
160.53	79	396.24	195	294.64	58	802.64	158
162.56	80	406.40	200	299.72	59	812.80	160
166.62	82	449.07	221	304.80	60	817.88	161
168.66	83	457.20	225	314.96	62	838.20	165
170.69	84	479.55	236	320.04	63	863.60	170
172.72	85	503.94	248	325.12	64	873.76	172
178.82	88	505.97	249	330.20	65	889.00	175
182.88	90	510.03	251	340.36	67	914.40	180
184.91	91	520.19	256	345.44	68	965.20	190
186.94	92	544.58	268	350.52	69	970.28	191
191.01	94	568.96	280	355.60	70	985.52	194
193.04	95	605.54	298	360.68	71	990.60	195
197.10	97	629.92	310	375.92	74	995.68	196
203.20	100	640.08	315	381.00	75	1046.48	206
205.23	101	680.72	335	396.24	78	1051.56	207
207.26	102	705.10	347	406.40	80	1097.28	216
209.30	103	731.52	360	411.48	81	1102.36	217
213.36	105	741.68	365	421.64	83	1112.52	219
215.39	106	812.80	400	426.72	84	1168.40	230
217.42	107	881.89	434	431.80	85	1264.92	249
219.46	108	920.50	453	441.96	87	1285.24	253
223.52	110	940.82	463	447.04	88	1305.56	257
227.58	112	1011.94	498	452.12	89	1473.20	290
229.62	113	1026.16	505	457.20	90	1600.20	315
231.65	114			462.28	91		
233.68	115			467.36	92		
243.84	120			477.52	94		
247.90	122			482.60	95		
249.94	123			487.68	96		
254.00	125			492.76	97		
256.03	126			497.84	98		
264.16	130			508.00	100		
268.22	132			533.40	105		
272.29	134			558.80	110		



## OPTIBELT HIGH PERFORMANCE TIMING BELTS

### optibelt DELTA CHAIN Carbon



Carbon fibre reinforcing cords embedded in tough polyurethane deliver exceptionally high power and torque transmission with a relatively narrow belt. **optibelt DELTA CHAIN Carbon** is also particularly well suited to low speed, high torque applications making it a credible, clean and maintenance-free alternative to roller chain.

- Up to 100% more power than even **optibelt OMEGA HP**
- Good resistance to chemicals / oils
- Smooth back allows use with back-side idler
- Up to 98% efficient

Standard Widths*	12, 21, 36, 62
Minimum pulley Ø	22 teeth = 56.02 mm
Temperature Range	-30°C to 80°C

\* Special widths available on request.

NEW POLYAMIDE FABRIC COATED TEETH FOR REDUCED WEAR, NOISE & FRICTION

CARBON TENSION CORD FOR ULTIMATE TENSILE STRENGTH

TOUGH POLYURETHANE

SMOOTH BACK SURFACE

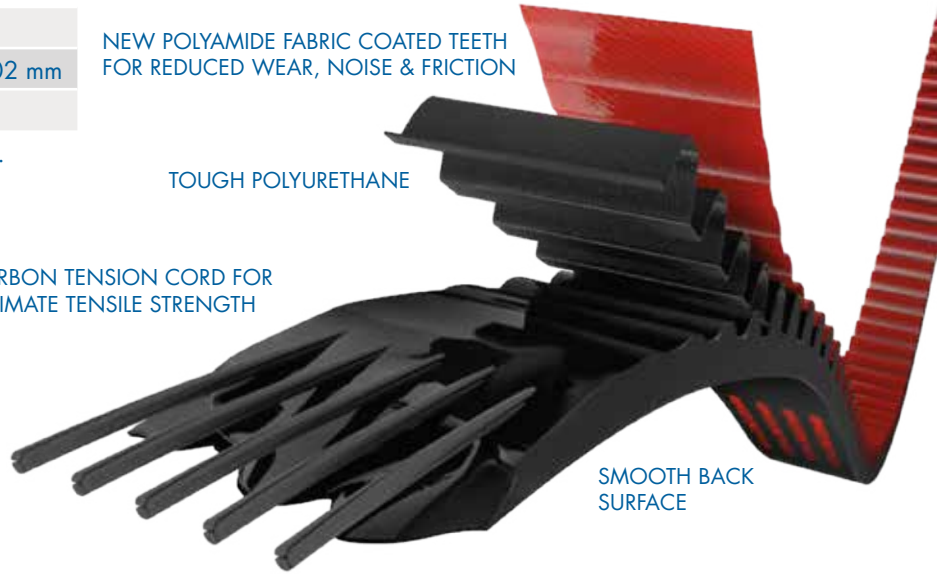

### optibelt ZRS DC PULLEYS

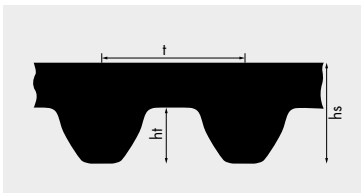

Profile	8MDC
t [mm]	8
h <sub>s</sub> [mm]	5.9
h <sub>t</sub> [mm]	3.4



Profile, length	Pitch length L <sub>w</sub> [mm]	Number of teeth
8MDC 640	640.00	80
8MDC 720	720.00	90
8MDC 800	800.00	100
8MDC 896	896.00	112
8MDC 960	960.00	120
8MDC 1000	1000.00	125
8MDC 1040	1040.00	130
8MDC 1120	1120.00	140
8MDC 1200	1200.00	150
8MDC 1224	1224.00	153
8MDC 1280	1280.00	160
8MDC 1440	1440.00	180
8MDC 1600	1600.00	200
8MDC 1760	1760.00	220
8MDC 1792	1792.00	224

**optibelt DELTA CHAIN Carbon** is designed to run in **optibelt ZRS DC** pulleys and is also compatible with alternative brands of timing pulley/"sprocket" including PC & CTD. It is not compatible with HTD pulleys.

Standard sizes are available to order from stock in 8MDC – Taperbore form. 14MDC and special versions are available to order.

Ordering Examples:

Belt: 720 8MDC 21

720mm Pitch length, 8MDC tooth pitch & profile, 21mm wide.

Taperbore Pulley: 8MDC 21 TB 34

8MDC tooth pitch & profile, to suit belt 21mm wide, Taperbore, 34 tooth.

Pilot bore Pulley: 8MDC 21 22

8MDC tooth pitch & profile, to suit belt 21mm wide, 22 tooth.

# OPTIBELT POLYURETHANE TIMING BELTS

## optibelt ALPHA TORQUE

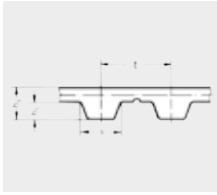

	t [mm]	h <sub>i</sub> [mm]	h <sub>s</sub> [mm]	s [mm]
<b>T2.5</b>	2.5	0.70	1.30	1.50
<b>T5</b>	5.0	1.20	2.20	2.65
<b>T10</b>	10.0	2.50	4.50	5.30

BELT  
DRIVES

T2.5		T5				T10			
Pitch Length (mm)	No. Teeth	Pitch Length (mm)	No. Teeth	Pitch Length (mm)	No. Teeth	Pitch Length (mm)	No. Teeth	Pitch Length (mm)	No. Teeth
120	48	165	33	690	138	260	26	1460	146
145	58	185	37	700	140	320	32	1500	150
160	64	200	40	720	144	350	35	1560	156
177,5	71	215	43	725	145	370	37	1600	160
180t	72	220	44	750	150	400	40	1610	161
200	80	225	45	780	156	410	41	1700	170
210	84	245	49	800	160	440	44	1750	175
230	92	250	50	815	163	450	45	1780	178
245	98	255	51	840	168	500	50	1800	180
265	106	260	52	850	170	530	53	1880	188
277,5	111	270	54	860	172	550	55	1960	196
285	114	275	55	900	180	560	56	2250	225
290	116	280	56	940	188	600	60		
305	122	295	59	990	198	610	61		
317,5	127	300	60	1000	200	630	63		
330	132	305	61	1075	215	650	65		
342,5	137	320	64	1100	220	660	66		
380	152	325	65	1115	223	690	69		
420	168	330	66	1140	228	700	70		
480	192	340	68	1215	243	720	72		
500	200	350	70	1315	263	750	75		
540	216	355	71	1350	270	780	78		
600	240	360	72	1380	276	800	80		
620	248	365	73	1440	288	810	81		
650	260	375	75			840	84		
780	312	390	78			850	85		
915	366	400	80			880	88		
950	380	410	82			890	89		
		420	84			900	90		
		425	85			910	91		
		430	86			920	92		
		440	88			950	95		
		445	89			960	96		
		450	90			970	97		
		455	91			980	98		
		460	92			1000	100		
		475	95			1010	101		
		480	96			1050	105		
		500	100			1080	108		
		510	102			1100	110		
		525	105			1110	111		
		545	109			1140	114		
		550	110			1150	115		
		560	112			1200	120		
		575	115			1210	121		
		590	118			1240	124		
		600	120			1250	125		
		610	122			1300	130		
		620	124			1320	132		
		625	125			1350	135		
		630	126			1390	139		
		640	128			1400	140		
		650	130			1420	142		
		660	132			1440	144		
		675	135			1450	145		

**OPTIBELT PULLEYS  
AVAILABLE TO SUIT**



## OPTIBELT POLYURETHANE TIMING BELTS

### optibelt ALPHA TORQUE



	t [mm]	h <sub>1</sub> [mm]	h <sub>2</sub> [mm]	b [mm]
<b>AT5</b>	5.0	1.20	2.70	2.50
<b>AT10</b>	10.0	2.50	5.00	5.00

AT5				AT10			
Pitch Length (mm)	No. Teeth	Pitch Length (mm)	No. Teeth	Pitch Length (mm)	No. Teeth	Pitch Length (mm)	No. Teeth
225	45	860	172	500	50	1150	115
255	51	975	195	530	53	1200	120
280	56	1050	210	560	56	1210	121
300	60	1125	225	600	60	1250	125
340	68	1500	300	610	61	1280	128
375	75			660	66	1300	130
390	78			700	70	1320	132
420	84			730	73	1350	135
450	90			780	78	1360	136
455	91			800	80	1400	140
500	100			840	84	1420	142
545	109			890	89	1480	148
600	120			920	92	1500	150
610	122			960	96	1600	160
660	132			980	98	1700	170
710	142			1000	100	1720	172
720	144			1010	101	1800	180
750	150			1050	105	1860	186
780	156			1080	108	1940	194
825	165			1100	110		

Other Profiles: Double Sided DT2.5, DT5, DT10    Classical MXL, XL, L

### optibelt ALPHA LINEAR & V (JOINED)

Polyurethane Timing Belts supplied open ended or joined to any length (multiple of pitch). Available with steel reinforcing cords as standard or Aramid cords for rust free applications.

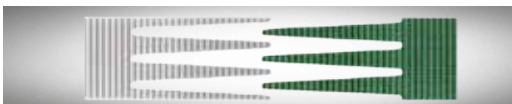
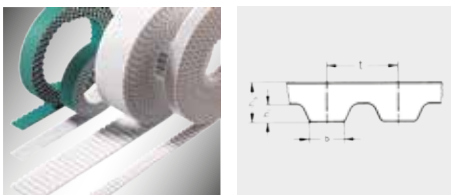

Alpha V joined belts can be welded to any length (multiple of pitch). Typically used for conveying applications.

Joint strength = approx. 50% of belt

Profile	Standard Widths	Profile	Standard Widths
<b>T5*</b>	6, 8, 10, 12, 16, 20, 25, 32, 50	<b>XL</b>	6.35; 7.94; 9.53; 12.70; 19.05; 25.40
<b>T10*</b>	10, 12, 16, 20, 25, 32, 40, 50, 75, 100	<b>L</b>	9.53; 12.70; 19.05; 25.40; 38.10; 50.80
<b>T20</b>	25, 32, 40, 50, 75, 100	<b>H</b>	12.70; 19.05; 25.40; 38.10; 50.80; 76.20; 101.60
<b>AT5*</b>	6, 8, 10, 16, 25, 32, 50, 75, 100	<b>XH</b>	25.40; 50.80; 76.20; 101.60
<b>AT10*</b>	16, 25, 32, 50, 75, 100, 150	<b>5M</b>	10.00; 15.00; 20.00; 25.00; 50.00
<b>AT20</b>	25, 32, 50, 75, 100, 150	<b>8M</b>	20.00; 25.00; 30.00; 50.00; 85.00; 100.00
		<b>14M</b>	25.00; 40.00; 55.00; 85.00; 100.00; 150.00

\*Available with tracking guides K6/K13

### optibelt ALPHA FLEX Truly Endless PU Timing Belts



Polyurethane is moulded around continuously wound steel or aramid tension cords allowing the production of long, truly endless belts with no join. Typically used for heavy duty motion control, indexing and conveying applications.

- Length range 1,100mm-12,000mm depending on profile. (Lengths up to 24,000mm possible by request)
- Available in profiles: T5,T10, T20, AT5, AT10, AT20, 5M, 8M, 14M, H
- Special options include : High flex, Stainless cords, PAZ fabric on teeth...

## OPTIBELT MODIFIED TIMING BELTS

### optibelt ALPHA SPECIAL

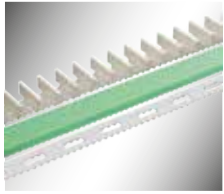

optibelt ALPHA SPECIAL belts are used wherever materials need to be conveyed, positioned or fed. An almost infinite number of solutions are possible including special backings, attachments and machining all produced at our dedicated factory.

#### COATED / BACKED BELTS

A huge variety of different backing materials can be added to the back of our Alpha timing belts (or other belts) to suit different material handling applications. Foam materials in PU or rubber can cushion and grip conveyed items while backings with profiled or textured surfaces can give additional purchase. Common backing materials include Rubber, Polyurethane and PVC all of which are available in various hardnesses, thicknesses and colours and with different chemical and mechanical properties. Due to space restrictions we are unable to list all varieties but some common types are shown below. Ask Optibelt via your IADA representative for further info.

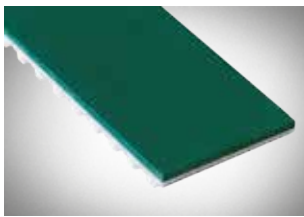

**PAR Fabric** – reduces wear and friction. Ideal for accumulation conveyors where belt needs to slide under product.



**Linatex Rubber**  
Hard wearing high grip. Thickness range 1.5-8.0mm

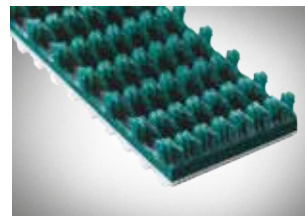

**Super Grip-Top**  
High positive grip. PVC & Rubber options.

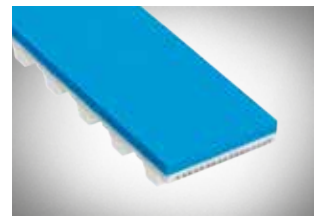

**Blue PU FDA**  
Blue FDA approved Polyurethane. Ideal for food conveying applications.

#### CLEATED / ATTACHMENT BELTS

A wide range of attachments can be welded or mechanically fastened onto our belts. We have many standard stock cleats but are also able to machine or injection mould custom made profiles. Cleats are ideal where accurate positioning or positive drive of a conveyed item is required e.g. pushing items up an incline or holding an item in a jig during processing.

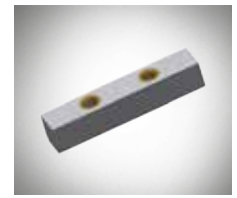
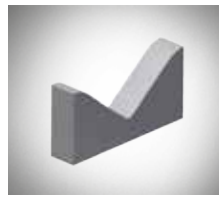
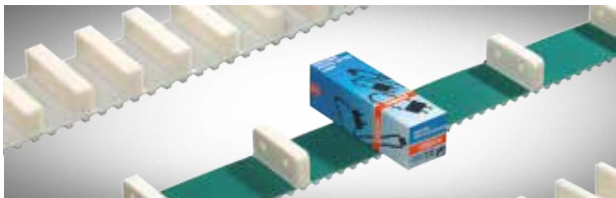

#### EXAMPLE OF COMMON CLEATS

#### MECHANICAL PROCESSING

Belts can be mechanically processed in a variety of ways including:

- Grinding (belt top surface or teeth)
- Milling (grooves in top surface or coatings)
- Waterjet cutting (cutting holes or slots in the belt)
- Punching (finger splicing)
- Drilling (longitudinal drilled hole in tooth)
- Cutting, carving (separating the coating)



#### MECHANICAL JOINTING

In addition to a permanent welded join in belts, Optibelt offer mechanical jointing methods:

**Pin Joint** : Allows belts to be joined to length on site, avoiding the need to disassemble machines to fit the belts.

Available in profiles : T10 & AT10 in widths 25, 32 & 50mm

**ZS/ZSI joint** allows belts to be joined via stainless or brass plates and is ideal where it is necessary to regularly remove and then re-assemble the belts e.g. for cleaning or re-tooling.

Available in profiles : T10 & AT10 in widths 25,32 & 50mm and H pitch in widths 1, 1.5 & 2 inch.

#### PIN JOIN

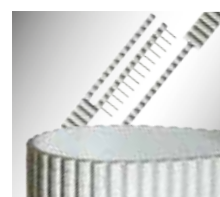

#### ZS/ZSI JOINT





## OPTIBELT RIBBED BELTS

### optibelt RB

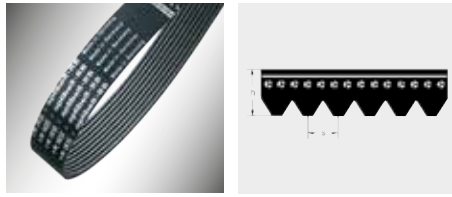

Profile	PH	PJ	PK	PL	PM
s [mm]	1.60	2.34	3.56	4.70	9.40
h [mm]	2.50	3.50	4.60	7.00	13.00

PH		PJ				PK				PL				PM	
Effective Length (mm)	Effective Length (inch)	Effective Length (mm)	Effective Length (inch)	Effective Length (mm)	Effective Length (inch)	Effective Length (mm)	Effective Length (inch)	Effective Length (mm)	Effective Length (inch)	Effective Length (mm)	Effective Length (inch)	Effective Length (mm)	Effective Length (inch)	Effective Length (mm)	Effective Length (inch)
698	27.50	280	11.00	1301	51.20	630	24.80	1570	61.80	954	37.50	4051	159.50	2286	90.00
735	28.90	330	13.00	1309	51.50	648	25.50	1600	63.00	991	39.00	4191	165.00	2388	94.00
762	30.00	356	14.00	1316	51.80	698	27.50	1655	65.20	1075	42.30	4470	176.00	2515	99.00
813	32.00	362	14.30	1321	52.00	730	28.70	1690	66.50	1194	47.00	4622	182.00	2693	106.00
858	33.80	381	15.00	1333	52.50	775	30.50	1755	69.10	1270	50.00	5029	198.00	2832	111.50
864	34.00	406	16.00	1355	53.40	800	31.50	1854	73.00	1333	52.50	5385	212.00	2921	115.00
886	34.90	414	16.30	1371	54.00	812	32.00	1885	74.20	1371	54.00	6096	240.00	3010	118.50
955	37.60	432	17.00	1397	55.00	830	32.70	1930	76.00	1397	55.00			3124	123.00
965	38.00	457	18.00	1428	56.20	865	34.00	1956	77.00	1422	56.00			3327	131.00
975	38.40	483	19.00	1439	56.70	875	34.50	1980	78.00	1562	61.50			3531	139.00
990	39.00	508	20.00	1475	58.10	890	35.00	2030	79.90	1613	63.50			3734	147.00
1016	40.00	559	22.00	1549	61.00	913	36.00	2050	80.70	1664	65.50			4089	161.00
1080	42.50	584	23.00	1600	63.00	920	36.20	2080	82.00	1715	67.50			4191	165.00
1092	43.00	610	24.00	1651	65.00	940	37.00	2120	83.50	1764	69.50			4470	176.00
1096	43.10	660	26.00	1663	65.50	954	37.60	2145	84.40	1803	71.00			4648	183.00
1168	46.00	711	28.00	1752	69.00	962	37.80	2170	85.40	1841	72.50			5029	198.00
1194	47.00	723	28.50	1780	70.00	990	39.00	2235	88.00	1943	76.50			5410	213.00
1200	47.20	737	29.00	1854	73.00	1015	40.00	2255	88.80	1981	78.00			6121	241.00
1222	48.10	762	30.00	1895	74.60	1080	42.50	2362	93.00	2020	79.50			6883	271.00
1230	48.40	813	32.00	1910	75.20	1090	43.00	2460	96.90	2070	81.50			7646	301.00
1262	49.70	836	32.90	1915	75.40	1125	44.30	2515	99.00	2096	82.50			8408	331.00
1270	50.00	864	34.00	1930	76.00	1150	45.30	2845	112.00	2134	84.00			9169	361.00
1285	50.60	914	36.00	1956	77.00	1165	45.90			2197	86.50			9931	391.00
1290	50.80	955	37.60	1965	77.40	1190	46.80			2235	88.00			10693	421.00
1301	51.20	965	38.00	1981	78.00	1200	47.20			2324	91.50			12217	481.00
1309	51.50	1016	40.00	1992	78.40	1222	48.10			2362	93.00			13741	541.00
1316	51.80	1092	43.00	2083	82.00	1230	48.40			2476	97.50			15266	601.00
1321	52.00	1105	43.50	2155	84.80	1245	49.00			2515	99.00				
1333	52.50	1110	43.70	2210	87.00	1270	50.00			2705	106.50				
1371	54.00	1123	44.20	2337	92.00	1285	50.60			2743	108.00				
1397	55.00	1130	44.50	2489	98.00	1290	50.80			2845	112.00				
1439	56.70	1150	45.30			1321	52.00			2895	114.00				
1475	58.10	1168	46.00			1330	52.40			2921	115.00				
1600	63.00	1194	47.00			1345	53.00			2997	118.00				
1854	73.00	1200	47.30			1371	54.00			3086	121.50				
1895	74.60	1222	48.10			1397	55.00			3124	123.00				
1915	75.40	1244	49.00			1439	56.70			3289	129.50				
1930	76.00	1262	49.70			1460	57.50			3327	131.00				
1956	77.00	1270	50.00			1520	59.80			3492	137.50				
1992	78.40	1285	50.60			1560	61.40			3696	145.50				
2083	82.00														
2155	84.80														

## OPTIBELT BELTS & KITS

### AUTOMOTIVE TECHNOLOGY

Optibelt are an Original Equipment supplier to many of the world's leading car and truck manufacturers and stock a wide range of OE quality belts and tensioner kits for the automotive aftermarket. The range includes : AVX V-belts, PK Ribbed belts, Timing belts, Timing belt kits and tensioners.



optibelt ZRK



optibelt TRUCK POWER  
MARATHON 2 M=S



optibelt RB



optibelt KIT

# INSTALLATION & MAINTENANCE – TOOLS & ADVICE

## HOW TO GET THE MOST OUT OF YOUR DRIVES

Optibelt only manufacture premium quality, high performance belts from which customers can expect to see lower running costs, reduced maintenance, increased productivity and reliability. But even Optibelt products can't perform to their best if they're not installed and, where necessary, maintained properly. Just a few simple steps which constitute maintenance good practice can ensure that your drives keep running efficiently and reliably for longer.

**Safety First: Before starting any work, always check that machinery is turned off and secure to work on.**

### 1. Check for pulley wear.

Worn V-pulleys place additional stresses on V-belts and result in premature wear. Optibelt pulley gauges help to show when pulleys are worn as shown



### 2. Always reduce centre distance

before fitting belts and then extend to tension. Never roll on belts under tension as this is likely to damage the cords inside the belt which will result in premature and unpredictable failure

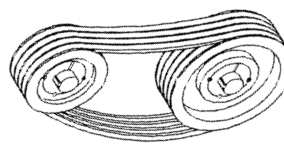

Tension cords likely to be damaged by rolling belts onto pulleys.

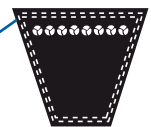

### 3. Check for pulley alignment.

Misaligned pulleys rapidly wear out belts and significantly reduce a drive's efficiency. It can also lead to other problems such as increased noise, vibration and heat. Alignment can be roughly checked with a straight edge but Optibelt's laser alignment tool makes the job quicker and more accurate. The laser simply clips magnetically onto the face of the pulley and beams a line onto magnetic targets placed on the other pulley(s) allowing the fitter to check for alignment and make adjustments while viewing the result.



optibelt LASER POINTER II - alignment tool



Optibelt CAP 6.0 drive calculation software is available as a free download from [www.optibelt.com](http://www.optibelt.com)

### 4. Fit belts at the correct tension:

Correct belt tension is critical to the longevity and efficiency of a drive. Tensioning information is provided by some machine manufacturers but, where that's not the case, Optibelt are able to advise and provide free drive calculation software. Because the optimum tension varies significantly from drive to drive, it is not possible to accurately check the tension by feel. Optibelt tension gauges allow a belt's tension to be measured quickly and accurately.

### 5. Maintain correct running tension:

After a short run-in period it is good practice to re-check the tension. With V-belts an initial drop of approx. 25% is expected and is planned for in the installation tension. Following this, tension should be checked periodically as part of routine maintenance. In particular, V-belts loose tension over time and will occasionally need to be re-tensioned in order to last and run efficiently. If this is not practical then we recommend the use of **optibelt RED POWER 3** – maintenance-free belts.



optibelt TT electronic tension measuring device



### Improved performance example - Air Compressor

3x XPZ 1400 belts on critical medical air compressors were lasting less than 12 months and required regular maintenance to avoid failure. A set of **optibelt RED POWER 3** belts were installed and correctly tensioned using an **optibelt TT** tension tester. 3 Years later the belts were still running and in good condition, having required no maintenance or re-tensioning during this time.

# BANDO

**BANDO** started as the **first belt manufacturer in Japan** over 100 years ago. BANDO offers **reliable and efficient solutions** for your **belt drives** with a wide range of **friction** and **synchronous** power transmission belts.

With our **worldwide** footprint in 14 countries with **19 manufacturing plants** in **Europe**, North America, and Asia, we meet the individual market requirements. We offer **tailored solutions** for our customer needs with our two distribution branches and one production facility in Europe. BANDO constantly strive to consider our customers' requirements in our daily work, and their **satisfaction** is our top priority.



PREMIUM QUALITY  
POWER TRANSMISSION BELTS  
— SINCE 1906 —



# BANDO BANFLEX™

**BANDO BANFLEX™** and **BANDO BANFLEX SCRUM™** V-belts were developed for **high speed drives** with a belt speed of up to 60 m/s.

Polyurethane rubber with **excellent abrasion resistance** and **large friction factor**. The enlarged profile angle provides **extremely low vibration** running.

Can be used with **small pulley** diameters for **high speed** ratios. Ideal for **lightweight** and **compact** transmission systems.

The back of the belt is diagonally grooved for more **flexibility**, **extended durability** and **energy efficiency**.

BANDO BANFLEX™



BANDO BANFLEX SCRUM™



Belt profiles of BANDO BANFLEX™ and BANDO BANFLEX SCRUM™

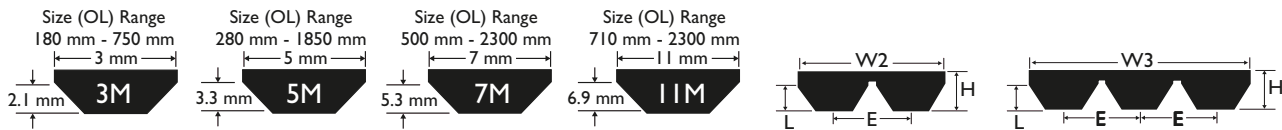

Table: Size list of BANDO BANFLEX™ and BANDO BANFLEX SCRUM™

Outside length [mm]	BANFLEX				BANFLEX SCRUM		
	3M	5M	7M	11 M	5MS	7MS	11 MS
180	•						
185	•						
190	•						
195	•						
200	•						
206	•						
212	•						
218	•						
224	•						
230	•						
236	•						
243	•						
250	•						
258	•						
265	•						
272	•						
280	•	•			•		
290	•	•			•		
300	•	•			•		
307	•	•			•		
315	•	•			•		
325	•	•			•		
335	•	•			•		
345	•	•			•		
355	•	•			•		
365	•	•			•		
375	•	•			•		

Outside length [mm]	BANFLEX				BANFLEX SCRUM		
	3M	5M	7M	11 M	5MS	7MS	11 MS
387	•	•			•		
400	•	•			•		
412	•	•			•		
425	•	•			•		
437	•	•			•		
450	•	•			•		
462	•	•			•		
475	•	•			•		
487	•	•			•		
500	•	•	•		•	•	
515	•	•	•		•	•	
518		•			•		
530	•	•	•		•	•	
545	•	•	•		•	•	
560	•	•	•		•	•	
563						•	
580	•	•	•		•	•	
600	•	•	•		•	•	
615	•	•	•		•	•	
630	•	•	•		•	•	
650	•	•	•		•	•	
670	•	•	•		•	•	
690	•	•	•		•	•	
710	•	•	•	•	•	•	•
730	•	•	•	•	•	•	•
750	•	•	•	•	•	•	•
775		•	•	•	•	•	•
800		•	•	•	•	•	•
805		•			•		
825		•	•	•	•	•	•
837						•	
850		•	•	•	•	•	•
875		•	•	•	•	•	•
900		•	•	•	•	•	•
925		•	•	•	•	•	•
950		•	•	•	•	•	•
975		•	•	•	•	•	•
1000		•	•	•	•	•	•
1030		•	•	•	•	•	•
1060		•	•	•	•	•	•
1090		•	•	•	•	•	•
1120		•	•	•	•	•	•
1150		•	•	•	•	•	•
1180		•	•	•	•	•	•
1220		•	•	•	•	•	•
1250		•	•	•	•	•	•
1280		•	•	•	•	•	•
1320		•	•	•	•	•	•
1360		•	•	•	•	•	•
1400		•	•	•	•	•	•
1450		•	•	•	•	•	•
1500		•	•	•	•	•	•
1550			•	•		•	•
1600			•	•		•	•
1650			•	•		•	•
1700			•	•		•	•
1750			•	•		•	•
1800			•	•		•	•
1850		•	•	•	•	•	•
1900			•	•		•	•
1950			•	•		•	•
2000			•	•		•	•
2060			•	•		•	•
2120			•	•		•	•
2180			•	•		•	•
2240			•	•		•	•
2300			•	•		•	•

## BANDO STS (STD) profile synchronous belt

**BANDO STS** belts are perfect for high torque synchronous power transmission applications previously driven by chains and gears.



Profile	Dimension [mm]			Material		Performance			Material		
	P	H1	H2	Rubber	Standard	High	Ceptor-VI	Ceptor-X	Polyurethane	Standard	King Power
SI.5M	1.5	1.12	0.57	●							
S2M	2.0	1.31	0.76	●					●	●	
S3M	3.0	2.10	1.14	●			●		●	●	
S4.5M	4.5	2.70	1.71	●							
S5M	5.0	3.61	1.91			●	●				
S8M	8.0	5.00	3.05			●	●	●			●
SI4M	14.0	8.70	5.30			●	●	●			●

## BANDO HTS (HTD) profile synchronous belt

**BANDO HP-HTS** tooth profile is designed to fit both, HTD pulleys and Generation II HTD pulleys.

Profile	Material		Performance	
	Rubber	Standard	High	
5M	●	●		
8M	●	●	●	
14M	●	●	●	



## BANDO Trapez profile synchronous belt

**Bancollan Timing Belts** made from highly durable polyurethane with steel cords for all industrial sectors.

Profile	Material	
	Rubber	Polyurethane
MXL	●	●
XL	●	●
L	●	●
H	●	
XH	●	
XXH	●	
T2.5		●
T5		●
T10		●





## Welcome to **MEGADYNE**

Founded in 1957 and based in Mathi (Italy), Megadyne is a global manufacturer of rubber and urethane drive belts and associated components used in power transmission, product handling and linear positioning applications. Megadyne has grown from being a small family company to an international leader in its related fields.

As part of the Ammega Group, we share the same vision:

*"We aspire to be the local partner of choice for belting solutions – around the globe."*



14 Factories in Europe, Asia and America  
+50 Commercial locations, + 2,000 Employees  
3 main hubs, one per Region

## Our strengths

After six decades of progressive expansion, organic development and strategic acquisitions, Megadyne remains committed to investing in best-in-class manufacturing, distribution and fabrication capabilities.

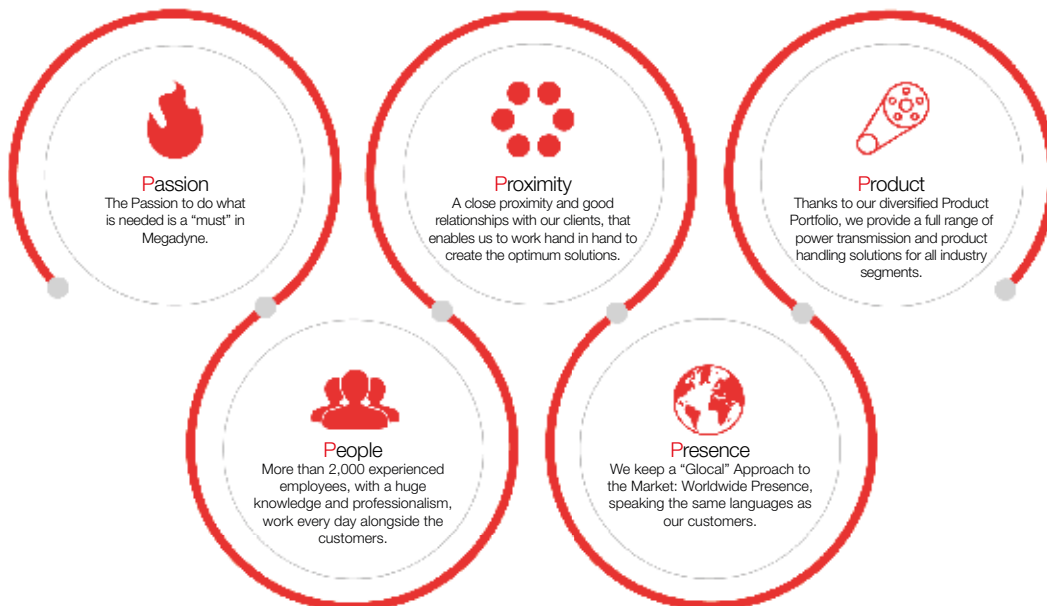

## TIMING BELTS

### ISORAN RUBBER TIMING BELTS

Rubber Endless Timing Belts available in single or double sided version, in classical pitches and RPP profiles. A large range of products available from stock.

**SECTIONS**

MXL - XL - L - H - XH - XXH - XL DD - L DD - H DD  
 RPP3 - RPP5 - RPP8 - RPP14  
 RPP5 DD - RPP8 DD - RPP14 DD  
 SLV5 - SLV2 8M - SLV2 14M - SLV8 DD - SLV14 DD  
 GOLD8 - GOLD14  
 PLT8 - PLT14



### ISORAN OPEN END BELTS

Open End Belts especially suitable for linear drives, accurate positioning and bidimensional drives, where the rotation has to be translated into a linear position. Available in classical and RPP profiles.



**SECTIONS**

MXL - XL - L - H - RPP3 - RPP5 - RPP8  
 RPP STEEL 8M - RPP STEEL 14M  
 SLV5 - SLV8 - STD8

### MEGAPOWER

Polyurethane Endless Timing Belts manufactured using a unique thermoset moulding process.

**SECTIONS**

MXL - XL - L\* - H\* - T2 - T2,5 - T2,5 DD  
 T5\* - T10\* - T5 DD\* - T10 DD\*  
 AT5 - AT10\*

(\*) available also with FC material



### MEGAFLEX

Polyurethane Endless Timing Belts made of thermoplastic polyurethane, with a continuous spiral cord.

**SECTIONS**

XL - L - H - XH - XL DD - L DD - H DD - XH DD  
 T5 - T10 - T20 - T5 DD - T10 DD - T20 DD  
 AT5 - AT10 - AT15 - AT20 - AT5 DD - AT10 DD - AT15 DD - AT20 DD  
 MTD 8M - ATG10 K13  
 RPP5 - RPP8 - RPP14 - RPP5 DD - RPP8 DD - RPP14 DD  
 P2



### MEGALINEAR

Open end timing belts made in thermoplastic polyurethane, available in both open-end or joined versions.

**SECTIONS**

MXL - XL - L - H - XH - T2,5 - T5\* - T10\* - T20  
 AT3 - AT5 - AT10 - AT20  
 RPP5 - RPP8 - RPP14 - RPP14 XHP  
 MTD3 - MTD5 - MTD8 - MTD14  
 STD5 - STD8  
 TG5 - TG10 K6 - TG10 K13 - TG20  
 ATG5 - ATG10 K6 - ATG10 K13 - ATG20 - HG  
 QST5 - QST8 - QST14  
 GW14 - GW20 - P1 - P2 - P3 - P4

(\*) available also with FC material





## FLAT BELTS

### MEGAFLAT (PU and RUBBER)

Flat Belts truly endless mandrel moulded, available with polyester, aramid or cotton reinforcements.

#### MEGAFLAT POLYURETHANE

SECTIONS: P0 - P102 - P105 - P107 - P108 - P110 - P120 - P155 - S108 - S110 - S120 - S155

#### MEGAFLAT RUBBER

SECTIONS: T75 - T108 - T110 - T120 - T150 - T155 - T200



## MULTI RIB BELTS



Endless Rubber Belts with longitudinal V shaped grooves providing high flexibility and great power performance.

### PV BELTS

SECTIONS: PH - PJ - PK - PL - PM

### MEGARIB

Ribbed Belts manufactured using a thermoset compound with polyester or polyamide high tension cord.

SECTIONS: PJ - PH - PTB2

## V-BELTS

### OLEOSTATIC GOLD – OLEOSTATIC – EXTRA

OLEOSTATIC GOLD in Z - A - B - C - D - E - SPZ - SPA - SPB - SPC  
EXTRA in Z - A - B - C - SPZ - SPA - SPB - SPC  
OLEOSTATIC in 20 - 25 - 45 - 50 - 3V - 5V - 8V

### ESAFLEX

SECTIONS: AA - BB - CC

### XDV2

SECTIONS: XDV 38 - XDV 48 - XDV 58



### LINEA GOLD

#### SECTIONS

AX - BX - CX - XPZ - XPA - XPB - XPC

### LINEA-X

#### SECTIONS

XPZ - XPA - XPB - XPC



### VARISECT

#### SECTIONS

13x6 - 17x6 - 21x7 - 22x8 - 26x8 - 28x8 - 30x10  
32x10 - 36x12 - 37x10 - 42x13 - 47x13  
52x16 - 55x16 - 65x20 - 70x20

### PLURIBAND

#### SECTIONS

RA - RB - RC - RSPZ - RSPA - RSPB - RSPC  
R3V - R5V - R8V - R3VX - R5VX

### ACCU-LINK

Accu-link may be used as an emergency belt in place of V-belts in case of unexpected failure, but is also originally installed in many industrial sectors.



## SPECIAL & FABRICATED BELTS

### MEGAWELD

A wide selection of trapezoidal and round weldable belts made in thermoplastic polyurethane by a unique extrusion process and suitable for numerous applications.



### COVERS and MODIFICATIONS

Megadyne can fully customise its belts with a variety of covers - in Polyurethane, Rubber elastomer, foam, PVC - and the following special modifications:



- Cleats
- False Teeth
- Custom shapes
- Grinding
- Notching/Knife Cut
- Fabric added to the tooth side of belt
- Holes/Perforations/Grooves/Vacuum Countersinks
- Pockets
- Slots
- Saw Tooth



### PPJ SYSTEM

Very fast belt replacement system to join belts directly on the machine.

## MECHANICAL POWER TRANSMISSION COMPONENTS

Megadyne stocks and supplies an extensive range of pulleys and accessories like timing bars, taper bushes, flanges, clamping plates... to offer a complete drive transmission system.



Never a problem,  
always a...

POWER  
TRANSMISSION



 **CHALLENGE** ®



[www.challengept.com](http://www.challengept.com)

## Challenge Engineering Pedigree

The Challenge brand represents 40 years of development, manufacture and refinement of the most comprehensive range of quality power transmission and engineered products available from any single source.

Challenge's global network of Regional Distribution Centers act as master importers; supplying Trade and OEMs with quality products on a wholesale-distribution basis. End users are served by their local sub distributor.

Quality, value and service are the foundations of the Challenge brand; we have unparalleled expertise in the manufacture and distribution of engineering products complying with all international standards, tolerances and technical requirements.

All Challenge manufacturing facilities are staffed by experienced engineers who are also able to offer custom made machine parts, ranging from raw castings to the finished product.

Our products are branded and bar coded using the latest technology for ease of replacement, order, stock and dispatch.

So don't forget; Never a problem, always a... ®

## Chain



Challenge's extensive range of Roller, Leaf, Timber, Agricultural and Conveyor chains not only offer all the manufacturing refinements and life optimising characteristics that today's engineers and designers expect; they do so without compromise in value or quality.

A full range of attachments are also available as are many types of specially designed chain to suit customer's specific requirements (e.g. sugar, cement, palm oil, bulk material handling etc).

This makes the Challenge chain range the ideal choice for any new build or replacement application.



## Sprockets

Sprockets are manufactured to the same exacting standards as Challenge chain. The range includes both taper bore and pilot bore sprockets in simplex, duplex and triplex. Double simplex sprockets are also available.

Challenge offers all standard sprockets ex-stock including BS and ANSI sprockets, plate wheels and idler sprockets.

Special sprockets are manufactured to order according to customer requirements.



## Belts

All belts feature international labeling and fully comply with ISO, BS, DIN and other international standards. The extensive Challenge range of quality belts include our:

- Classical V-Belts (Z, A, B, C, D)
- Classical CRE V-Belts (AX, BX)
- Wedge Belts (SPZ, SPA, SPB, SPC, SPP)
- CRE Wedge Belts (SPAX, SPBX, SPCX)
- Narrow V belts (3V, 5V, 8V)
- Classical Timing Belts including sleeves (XL, L, H, XH)
- Curved Tooth Timing Belts including sleeves (HTD in 3M, 5M, 8M and 14M)
- Other belts to suit agricultural and automotive applications are available to special order



## Pulleys

The Challenge range of 'V' pulleys are produced with taper bore configuration and conform to ISO 4183. Pulleys are produced from phosphated GG25 grade cast iron and are balanced to Q6.3 or better.

Challenge also manufacture taper bore and pilot bore classical pulleys, HTD and metric timing pulleys, plus special timing pulleys to the same demanding specifications.



## Taper Bushes & Hubs

For torque transmission you need the maximum contact area. Challenge's high machining tolerances deliver just that, with over 500 metric and imperial bore sizes of taper bush available and manufactured from close grain cast iron.

To complement our range of shaft fixings, Challenge also manufacture precision machined low carbon steel Weld-on-Hubs, as well as phosphated Bolt-on-Hubs in GG22 cast iron, plus a broad range of keyed and keyless adaptors; ideal for our pilot bored components.



## Cone Clamping Elements

Challenge Shaftlock keyless shaft fixings come in a wide range of size and configurations and are simple to install and uninstall.

Challenge Shaftlock is a premium grade locking assembly with high machining tolerances and surface finishes resulting in high torque ratings.



## Shaft Mounted Speed Reducers (SMSR)

The workhorse on many conveyors, Challenge's range of metric SMSRs and imperial TXT units are fully interchangeable with other manufacturers and are supplied complete with a torque arm. The Metric SMSR is available with the Grip-Loc hub system or standard output hubs with reducing bushes. The TXT unit is available with a full range of imperial output hub bushings. Backstops for both units are available and sold separately.

Consistent quality and close tolerances are guaranteed by Challenge's production line manufacturing and all units are fully traceable via a unique serial number. Challenge gearboxes are test run for 30 minutes before final quality control and drained of oil before shipment.



## Torque Limiters

The torque limiter range from Challenge will save money in damage and downtime, with its zero manual re-setting and simple installation, this unit works with our plate wheels, sprockets, gears, pulleys, couplings etc.



## Shaft Couplings

Challenge shaft couplings are suitable for use in a wide range of applications.

The range encompasses FFX tyre coupling, HRC, Jaw and Chain shaft couplings as well as our NPX, RPX and CNM couplings which match industry standards.

Whether you need to absorb shock from a crusher or drive a smooth running generator, Challenge has a suitable coupling for your application.



## Motor Mounts

Manufactured from galvanized steel, Challenge motor mounts maintain your motor's alignment and drive tension, whilst reducing vibration and noise. They are easily adjustable and available in five motor frame sizes covering 63 to 180.

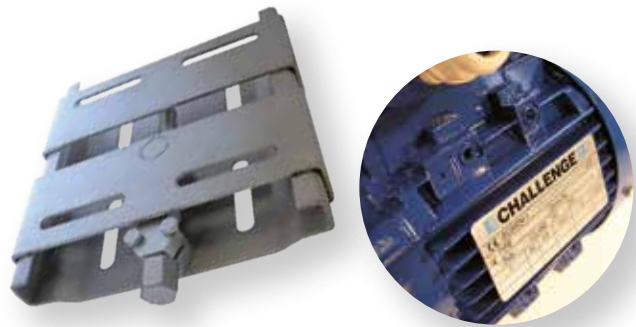

POWER  
TRANSMISSION

## Electric Motors

The Challenge range of three phase electric motors comply with IEC 60034 standards and are available in IE1, IE2 and IE3 efficiencies. The motors are approved having fan cooled, high grade cast aluminium alloy squirrel caged construction, incorporating engineering grade plastic terminal boxes. All motors have multi-mount feet and thus can achieve numerous mounting positions.



## Worm Gear Units

Challenge offer a range of worm gear units with aluminium alloy cases. This extremely versatile unit can be offered with output shafts, electric motors, input flanges, torque arms with many different configurations to fulfil most application criteria. The sizes match industry standards.



## Bearings

Our range of bearings includes metric 1600, 6000, 6200, 6300 and 6800/6900 series, and R series imperial bearings. All our roller bearings are shielded for longer life and ease of maintenance. We also stock a popular range of metric and imperial taper roller bearings and spherical roller bearings. Special + non standard bearings are available upon request.





### Bearing Units

Challenge Triple Seal Pillow blocks, 2 and 4 hole flange units and take-up units all have triple lipped seals fitted as standard. These triple seals ensure the longevity of these bearing units and make them ideal for high dust environments such as in agriculture, mining and quarrying applications. Additional options include: pressed steel housings, plastic housings + stainless steel housings + inserts.

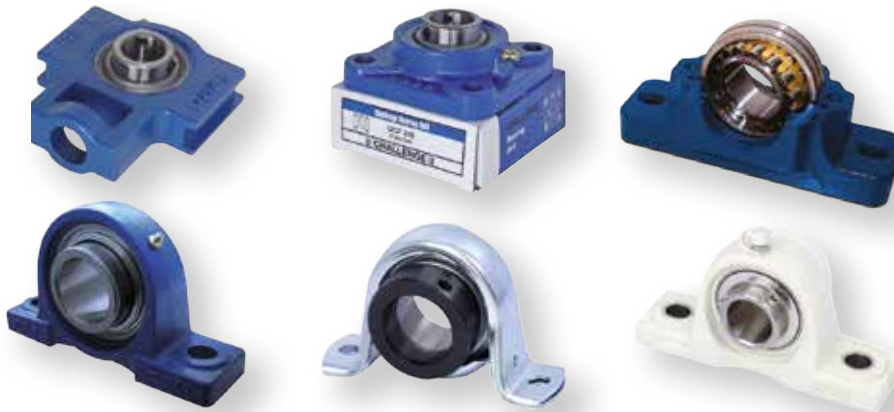

### Agri Range



Challenge AGRI Chain – These chains for agricultural machinery are fully interchangeable with major machinery manufacturers and are aimed at the replacement market. Incorporating the most advanced heat treatment processes and a special lubricant, these chains are engineered specifically to cope with the conditions persistent in agricultural applications.

Challenge AGRI Bearings – This expanding range consists mainly of industry standard bearing units with double lipped seals and wheel bearing kits for specific machines. These industry standard bearings are manufactured using chromium bearing steels and filled with proprietary lithium based grease.



Challenge AGRI Belts – This range of high quality fan and drive belts for agricultural machinery are produced to the same exacting specification as our standard range of V and Wedge belts. Top quality together with excellent stock availability and reasonable pricing mean that these popular belts are quickly becoming the standard for agricultural users around the world.

The new generation Challenge hub for tillage, seeding and marking discs with a special sealing arrangement and brand new range of PTO units are also available within our agricultural range.



### Challenge Technical Catalogue

The Challenge Power Transmission Technical Catalogue covers our entire range of products in our 430 page publication. Contact your local Challenge Sales office for your copy now.



Never a problem always a ...

**CHALLENGE**<sup>®</sup>  
www.challengept.com

POWER  
TRANSMISSION

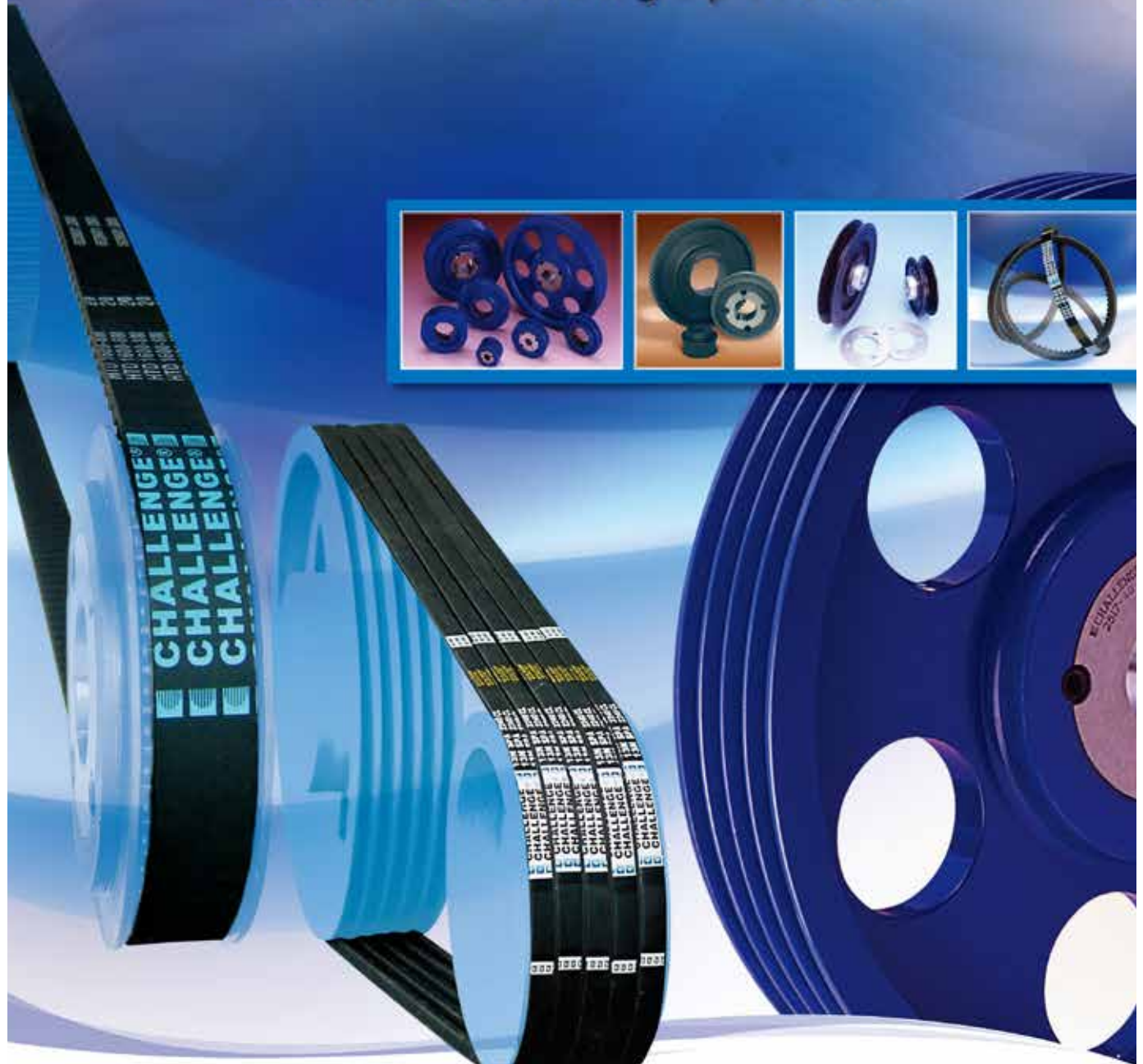

# Belt Drives

**CHALLENGE**<sup>®</sup>  
www.challengept.com



Never a problem always a ...

**CHALLENGE**®

www.challengept.com



# Chain Drives

**CHALLENGE**®  
www.challengept.com



Never a problem always a ...

**CHALLENGE**  
www.challengept.com



# Couplings

**CHALLENGE**  
www.challengept.com



Never a problem always a ...

**CHALLENGE**<sup>®</sup>  
www.challengept.com



# Shaft Fixings

**CHALLENGE**<sup>®</sup>  
www.challengept.com





Flange Units



Plummer Blocks



Bolt on Hubs



Taper Bore Pulleys



Pillow blocks



Electric Motors



AFX Couplings



Pop Metric Bearings

Taper Roller Bearings



Conveyor Sprockets



Taper bushes



Torque Limiters



Timing Pulleys

THE WIDEST RANGE OF  
POWER TRANSMISSION  
PRODUCTS UNDER  
ONE BRAND



Weld on Hubs

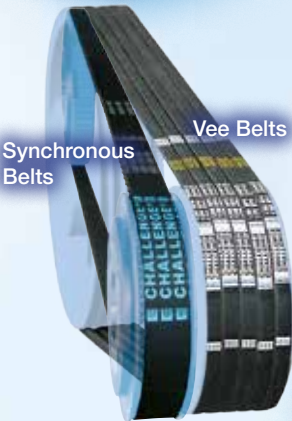

Synchronous Belts

Vee Belts



Clamping Elements



Transmission Sprockets

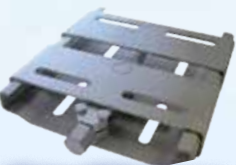

Motor Slide Bases



Geared Drives



Shaft Mounted Speed Reducers



All types of Chain



Leaf Chain



CRE Belts



RPX Couplings



HRC Couplings



CNM Couplings



Jaw Couplings



Chain Couplings



NPX Couplings

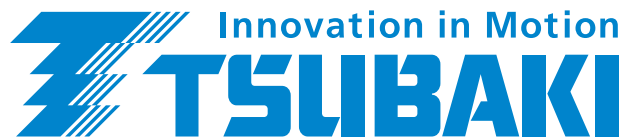

## JAPANESE PRECISION



Located in Kansai Science City, the Kyotanabe plant embodies our wide spectrum of cutting-edge technological solutions. Our aim is to develop this environmentally friendly facility into the world's number one chain plant. Furthermore, Kyotanabe's Technical Centre plays a vital role within the Tsubaki Group through its R&D activities and distribution of knowledge. The Kyotanabe plant is an excellent example of a facility built on the foundation of Tsubaki's technical expertise.



### Consideration for the Global Environment

The Tsubaki Group is working to conserve the environment and reduce the environmental impact of its operations by improving the efficiency of its manufacturing activities.



In addition, the Tsubaki Group will continually take on the challenge of sustainable value creation by advancing the development of environmentally friendly products.

These eco-products help customers reduce energy consumption and improve the economic aspects of their operations.

### About TSUBAKI

Established in 1917, Tsubakimoto Chain Company is the world's premier manufacturer of power transmission products with strong market positions in premium quality ANSI & BS roller conveyor & engineering chains and associated power transmission components such as Cam Clutches, reducers & linear actuators.

At TSUBAKI we know that customers want the best. Indeed, we take pride in our ability to deliver an extensive product lineup that satisfies these high expectations. We are also aware that each and every one of our customers has unique requirements. Our focus is on providing our customers around the world with concrete solutions by developing products to suit different countries, regions and business environments. Tsubakimoto UK in Nottingham, serves the markets of the UK, Ireland and Iceland.

### Stockholding UK/Europe

TSUBAKI stocks a wide range of standard power transmission products; many of which provide innovative solutions. We pride ourselves on customer service excellence and understand the importance of having stock available to fulfil our customer's requirements. The UK and European warehouse hold stock in excess of £1.8m and offer a wide product range of drive, conveyor, attachment chains & sprockets. We also supply power transmission component products such as Cam Clutches, torque limiters and couplings.

[tsubaki.eu](http://tsubaki.eu)

## TSUBAKI SOLUTIONS LINE-UP



POWER  
TRANSMISSION



### GT4 Winner: General Purpose

- Seamless bushing and lubrication grooves to improve wear resistance
- Centre sink pin rivet for easy disassembly
- Ring coined connecting link for maximum transmission capacity



### Lambda: Lube Free

- Provides low maintenance and clean operation, no external lubrication required
- Bushing impregnated with lubrication for improved wear resistance
- Centre sink pin rivet for easy disassembly
- Ring coined connecting link for maximum transmission capacity



### Titan: Anti Dust and Abrasives

- Special coated pin for wear resistance in harsh/dusty applications
- Seamless bushing and lubrication grooves to improve wear resistance
- Centre sink pin rivet for easy disassembly
- Ring coined connecting link for maximum transmission capacity



### HEAVY DUTY

### Heavy Series: Increased Strength

- Extra transmission capacity
- Highly resistant to shock loads
- Superior tensile strength and fatigue resistance
- Extended life due to perfectly cylindrical solid bush



### NEPTUNE™

### Neptune: Anti Corrosion

- Special coating provides excellent corrosion protection
- Resists common food industry wash down chemicals and salt water
- Seamless bushing and lubrication grooves to improve wear resistance
- Centre sink pin rivet for easy disassembly
- Ring coined connecting link for maximum transmission capacity



### PC CHAIN

### PC Chain: Anti Corrosion

- Stainless Steel links to resist corrosion
- Engineering plastic provides self lubrication
- Light weight and low noise



### STAINLESS STEEL

### Stainless Steel: Anti Corrosion

- Highly resistant in corrosive environments
- Wide temperature range (-20 degC to 400 degC)
- All components made of 304SS austenite stainless steel (SUS304)



## ROLLER CHAIN GT4 WINNER

TSUBAKI GT4 Winner is the most advanced BS/DIN standard roller chain in the European market. Since 1917 Tsubakimoto Chain Company has maintained a line-up of cutting-edge chain products with exceptional quality and performance. TSUBAKI is proud of the 4th generation, enhanced European premium BS/DIN chain.

### Advantages

TSUBAKI RS roller chain GT4 Winner is enhanced with the following advantages:

#### Wear resistance

TSUBAKI's patented LG (Lube Groove) seamless bushes are precision components and perfectly cylindrical. Our special lube grooves hold oil at the point of contact, where the chain needs it most. The result is a chain that lasts longer with lower maintenance costs over the lifetime of the chain. The Lube Groove is applied to RS16B, RS20B and RS24B.

#### Easy disassembling with centre sink pin design

The chains can be easily and safely disassembled with a standard screw type cutter without damaging bushes. Center sink riveting is applied to RS08B up to RS16B single strand chain.

#### Increased kW Rating

The TSUBAKI Ring Coining process on the connecting link plate allows the chain to be specified up to its full kW rating.



Ring Coined Connecting Link Plate

In general, connecting links have a 20% lower fatigue strength than the chain itself. However, TSUBAKI developed a special process to eliminate that loss of fatigue strength and still satisfy the customers demand for easy assembly: the Ring Coining process. Generating a cold deformation around the pin hole of the connecting link plate results in residual stress around this region, thereby adding strength. By using this process we can achieve 100% transmission capacity of the base chain.

### Constant Quality Level

In pursuit of outstanding quality, every TSUBAKI chain is made of a special steel alloy, the specification of which has been developed by the TSUBAKI engineering department for selected steel mills to work with. TSUBAKI produces the GT4 Winner under highly controlled conditions in its advanced heat treatment facilities. This, in combination with TSUBAKI fatigue strength tests, ensures that our customers can always rely on a constant level of quality whenever using TSUBAKI products.

### Customized Pre-Lubrication Service

Proper lubrication is the key to extending the life and improving the performance of a chain. In order to get the best performance in general applications (-10°C to +60°C), all GT4 Winner drive chains are pre-lubricated.

For special applications, TSUBAKI can provide chains which are pre-lubricated with a special lubricant on customer demand:

- High temperature
- Low temperature
- Food safe
- Outdoor exposure
- Dusty environment

Please consult TSUBAKI for more detailed information.



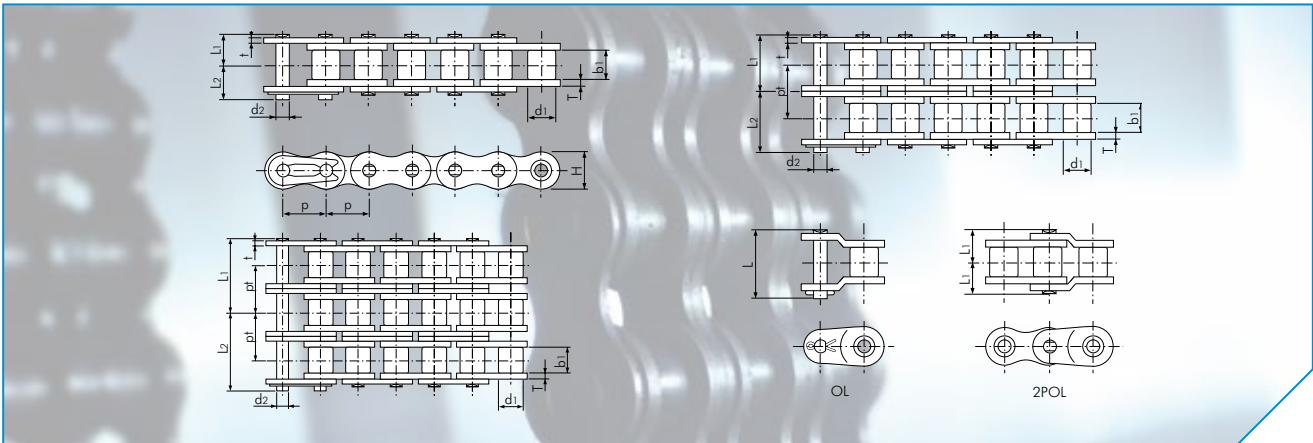

POWER TRANSMISSION

## GT4 WINNER

Dimensions in mm

TSUBAKI Chain No.	Pitch p	Roller Diameter d1	Inner Width b1	Pin			Link Plate			Transverse Pitch pt	Min. Tensile Strength acc. to ISO 606 kN	Min. Tensile Strength acc. to TSUBAKI kN	Approx. Mass kg/m			
				Diameter d2	Length L1	Length L2	Length L	Thickness T	Thickness t					Height H (max)		
RS05B-1	8.00 (0.315")	5.00	3.00	2.30	3.80	4.70	-	0.75	0.75	7.10	-	4.4	5.0	0.18		
RS05B-2					6.65	7.55	-				5.64	7.8	7.8	0.35		
RS05B-3					9.45	10.35	-				5.64	11.1	11.1	0.53		
RF06B-1	9.525 (3/8")	6.35	5.72	3.27	6.10	7.70	15.10	1.30	1.00	8.20	-	8.9	9.0	0.39		
RF06B-2					11.20	12.80	25.90				10.24	16.9	17.0	0.75		
RF06B-3					16.40	17.90	36.10				10.24	24.9	24.9	1.11		
RS08B-1	12.70 (1/2")	8.51	7.75	4.45	8.40	10.00	18.60	1.60	1.60	11.80	-	17.8	19.0	0.70		
RS08B-2					15.30	16.90	34.50				13.92	31.1	32.0	1.35		
RS08B-3					22.25	23.85	48.40				13.92	44.5	47.5	2.00		
RS10B-1	15.875 (5/8")	10.16	9.65	5.08	9.55	11.25	20.80	1.50	1.50	14.70	-	22.2	23.0	0.95		
RS10B-2					17.85	19.55	39.40				16.59	44.5	44.5	1.85		
RS10B-3					26.15	27.85	56.00				16.59	66.7	66.8	2.80		
RS12B-1	19.05 (3/4")	12.07	11.68	5.72	11.10	13.00	24.40	1.80	1.80	16.10	-	28.9	31.0	1.25		
RS12B-2					20.85	22.75	45.90				19.46	57.8	61.0	2.50		
RS12B-3					30.60	32.50	65.40				19.46	86.7	92.0	3.80		
RS16B-1	25.40 (1")	15.88	17.02	8.28	17.75	19.95	41.10	4.00	3.20	21.00	-	60.0	70.0	2.70		
RS16B-2					33.55	35.75	75.20				31.88	106.0	128.0	5.40		
RS16B-3					49.50	51.70	107.10				31.88	160.0	192.0	8.00		
RS20B-1	31.75 (1 1/4")	19.05	19.56	10.19	19.90	23.10	46.60	4.40	3.40	26.00	-	95.0	98.1	3.85		
RS20B-2					38.25	41.45	84.60				36.45	170.0	197.0	7.65		
RS20B-3					56.50	59.70	121.00				36.45	250.0	295.0	11.45		
RS24B-1	38.10 (1 1/2")	25.40	25.40	14.63	26.65	31.85	61.70	6.00	5.60	33.40	-	160.0	167.0	7.45		
RS24B-H-1					29.30	34.20	-				7.50	6.00	36.20	-	234.0	8.20
RS24B-2					50.80	56.00	112.80				48.36	280.0	335.0	14.65		
RS24B-3	75.10	80.20	161.10	48.36	425.0	500.0	21.75									
RS28B-1	44.45 (1 3/4")	27.94	30.99	15.90	32.45	37.45	74.40	7.50	6.30	36.40	-	200.0	200.0	9.45		
RS28B-2					62.15	67.15	136.60				59.56	360.0	374.0	18.80		
RS28B-3					91.95	96.95	195.90				59.56	530.0	560.0	28.20		
RS32B-1	50.80 (2")	29.21	30.99	17.81	32.10	37.70	73.30	7.00	6.30	42.20	-	250.0	255.0	10.25		
RS32B-2					61.25	66.85	134.50				58.55	450.0	485.0	20.10		
RS32B-3					90.50	96.10	192.60				58.55	670.0	729.0	29.90		
RS40B-1	63.50 (2 1/2")	39.37	38.10	22.89	39.25	45.05	88.60	8.50	8.00	52.90	-	355.0	373.0	16.35		
RS40B-2					75.40	81.20	163.20				72.29	630.0	716.0	32.00		
RS40B-3					111.50	117.30	235.30				72.29	950.0	1080.0	47.75		
RS48B-1	76.20 (3")	48.26	45.72	29.23	49.30	58.80	117.70	12.10	10.00	63.80	-	565.0	565.0	25.00		
RS48B-2					95.00	104.40	209.00				91.21	1000.0	1000.0	50.00		
RS48B-3					140.60	150.00	300.20				91.21	1500.0	1520.0	75.00		

**Note:**

- For sizes RS16B - RS24B Lube Grooves (LG) are applied
- Connecting links are clip type for sizes up to RS16B, and cotter type for sizes RS20B to RS48B.
- RF06B chain has flat-shaped link plates.
- Intermediate plate of multi strand RF06B-2 and RS08B-2 chain is a solid plate.
- Center sink riveting is applied to RS08B-1 to RS16B-1 single strand chain.
- Double stake riveting is applied to all other sizes including multi-strand chain.
- When a single pitch offset link is used, please calculate a 40% reduction of the fatigue strength.
- RS24B-H-1 chain is a reinforced RS24B-1 chain.

## LAMBDA LUBE FREE ROLLER CHAIN

TSUBAKI's LAMBDA Chains were the first in the industry to use a special oil impregnated bush. Since their launch in 1988, they have been adopted for diverse industries and applications, and their performance has been highly rated. TSUBAKI has a wide line-up of lube-free, long life products that help customers reduce costs.

### Technical Evolution

As a pioneer in the lube-free chain market, TSUBAKI will reveal some of the key elements behind LAMBDA's outstanding performance:

#### Sintered Oil Impregnated Bush

The microscopic pores in the seamless sintered bush are vacuum filled with high performance NSF-H1 lubricant. This innovation provides a 30%\* longer wear life.

\* Average increase compared to the previous generation of Lambda chain.

#### Special Coated Pin

The special coating on the pin surface enhances the long term internal lubrication.

#### Centre Sink Rivet

The unique centre sink pin design offers easy chain disassembly and the markings on the rivet head will identify pin rotation.

#### Ring Coin

The Ring Coin connecting link ensures that the chain can be specified up to its full chain capacity.

#### Special Environments

TSUBAKI LAMBDA has outstanding performance in temperatures up to +150°C.

For temperatures above +150°C: Due to special NSF-H1 certified lubrication impregnated bushes, TSUBAKI LAMBDA KF Series is usable in a wide temperature range (from -10°C to +230°C) while at the same time being kind to the environment. Please consult TSUBAKI for more detailed information.

### Advantages

TSUBAKI has enhanced the LAMBDA with the following advantages:

#### Save Maintenance Costs

No expensive labour costs as it is not required to manually lubricate this chain.

#### Save Purchasing Costs

Lower frequency of purchasing due to the high quality of the chain and its long economic life. No purchasing of lubricants or lubrication systems necessary.

### Higher Productivity

No unforeseen downtime due to chain breakdown. Less time required for maintenance and therefore more time for production.

### Environmental Friendly

Applications run clean thus reducing the risk of contaminating products, machines, floor etc. In addition, the LAMBDA chain is ideally suited for food industry applications due to the use of a NSF-H1 lubricant.

### Interchangeability

*Chains:*

BS LAMBDA Chains are fully interchangeable with standard BS roller chains.

*Sprockets:*

Standard BS roller chain sprockets can be used. However, due to the extended lifetime of BS LAMBDA chain, TSUBAKI recommends to install sprockets with hardened teeth in every LAMBDA application.



Basic Construction

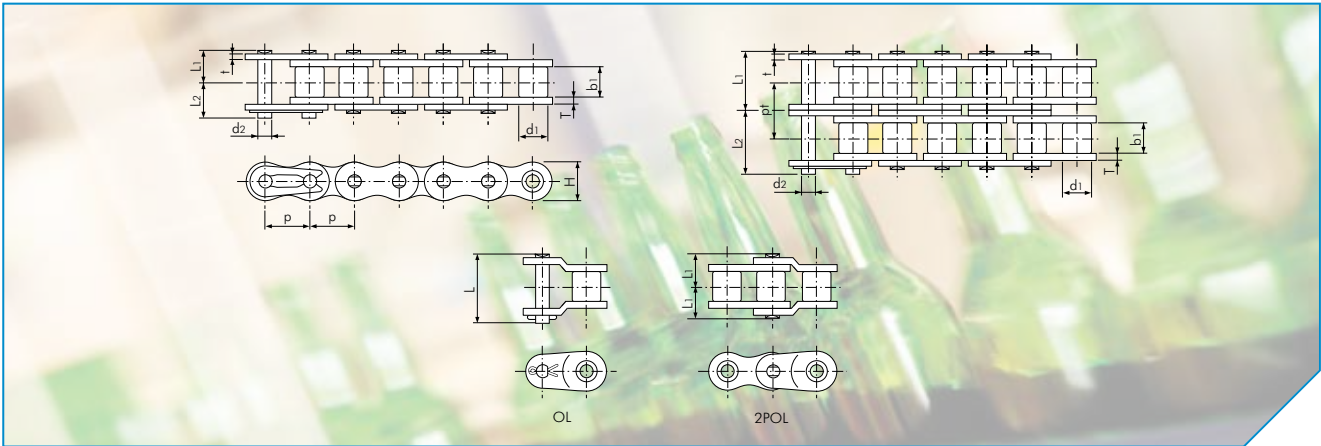

**POWER TRANSMISSION**

## BS LAMBDA Chain

Dimensions in mm

TSUBAKI Chain No.	Pitch p	Roller Diameter d1	Inner Width b1	Pin				Link Plate			Transverse Pitch pt	Min. Tensile Strength acc. to ISO 606 kN	Approx. Mass kg/m
				Diameter d2	Length L1	Length L2	Length L	Thickness T	Thickness t	Height H (max)			
RF06B-1M-1	9.525 (3/8")	6.35	5.72	3.28	6.10	7.70	15.10	1.30	1.00	8.20	-	8.9	0.39
RF06B-1M-2					11.20	12.80	25.90				10.24	16.9	0.75
RS08B-1M-1	12.70 (1/2")	8.51	7.75	4.45	8.40	10.00	18.60	1.60	1.60	11.80	-	17.8	0.70
RS08B-1M-2					15.30	16.90	34.50				13.92	31.1	1.35
RS10B-1M-1	15.875 (5/8")	10.16	9.65	5.08	9.55	11.25	20.80	1.50	1.50	14.70	-	22.2	0.95
RS10B-1M-2					17.85	19.55	39.40				16.59	44.5	1.85
RS12B-1M-1	19.05 (3/4")	12.07	11.68	5.72	11.10	13.00	24.40	1.80	1.80	16.10	-	28.9	1.25
RS12B-1M-2					20.85	22.75	45.90				19.46	57.8	2.50
RS16B-1M-1	25.40 (1")	15.88	17.02	8.28	17.75	19.95	41.10	4.00	3.20	21.00	-	60.0	2.70
RS16B-1M-2					33.55	35.75	75.20				31.88	106.0	5.40
RS20B-1M-1	31.75 (1 1/4")	19.05	19.56	10.19	19.90	23.10	46.60	4.40	3.40	26.40	-	95.0	3.85
RS20B-1M-2					38.25	41.45	84.60				36.45	170.0	7.65
RS24B-1M-1	38.10 (1 1/2")	25.40	25.40	14.63	26.65	31.85	61.70	6.00	5.60	33.40	-	160.0	7.45
RS24B-1M-2					50.80	56.00	112.80				48.36	280.0	14.65

## ANSI LAMBDA Chain

Dimensions in mm

TSUBAKI Chain No.	Pitch p	Roller Diameter d1	Inner Width b1	Pin				Link Plate			Transverse Pitch pt	Min. Tensile Strength acc. to TSUBAKI kN	Approx. Mass kg/m
				Diameter d2	Length L1	Length L2	Length L	Thickness T	Thickness t	Height H (max)			
RS40-1MD-1	12.70 (1/2")	7.92	7.55	3.97	8.75	10.45	20.00	2.00	1.50	12.00	-	17.7	0.70
RS40-1MD-2					16.50	18.10	-				15.40	35.3	1.40
RS50-1MD-1	15.875 (5/8")	10.16	9.26	5.09	10.75	12.45	24.00	2.40	2.00	15.00	-	28.4	1.11
RS50-1MD-2					20.20	22.00	-				19.00	56.9	2.20
RS60-1MD-1	19.05 (3/4")	11.91	12.28	5.96	13.70	15.70	32.00	3.20	2.40	18.10	-	40.2	1.72
RS60-1MD-2					26.05	28.05	-				24.52	80.4	3.40
RS80-1MD-1	25.40 (1")	15.88	15.48	7.94	17.15	20.25	39.90	4.00	3.20	24.10	-	71.6	2.77
RS80-1MD-2					32.70	35.90	-				31.10	143.0	5.50
RS100-1MD-1	31.75 (1 1/4")	19.05	18.70	9.54	20.65	23.85	47.50	4.80	4.00	30.10	-	107.0	4.30
RS100-1MD-2					39.50	42.50	-				37.60	214.0	8.60
RS120-1MD-1	38.10 (1 1/2")	22.23	24.75	11.11	25.75	29.95	59.00	5.60	4.80	36.20	-	148.0	6.40
RS140-1MD-1					44.45	32.20	63.70				6.40	5.60	42.20

**TITAN**  
TSUBAKI TITAN CHAINS

## OUR LATEST INNOVATION

TSUBAKI Titan chain is the latest innovation from TSUBAKI's research & development with the goal to increase wear life in harsh conditions that cause dust contamination and abrasion.

Our TSUBAKI Titan chain combines the best features of our general purpose GT4 Winner chain with new and unique specifications, delivering the ultimate in wear performance.

### Chain features

#### Special Coated Pins

Special coated pins provide an extra hard and low friction surface, thus increasing wear life. As a result, maintenance cost, downtime and the Total Cost of Ownership are reduced to a minimum.

#### Seamless Bushes with Lube Grooves

TSUBAKI LG (Lube Groove) seamless bushes are precision components and perfectly cylindrical. The special Lube Grooves hold oil at the point of contact, where the chain needs it most. This limits the wear between pin and bush, significantly improving the wear life as a result.

#### Corrosion Resistance

Nickel plated outer link plates combined with blackoxide inner link plates provide an extra layer of protection against corrosion.

#### Ring Coin

TSUBAKI's unique Ring Coin Connecting Links ensure that the chain can be specified up to its full capacity.



1 Lube Grooves (LG)  
RS16B - RS24B

2 Seamless Bush

3 Special Coated Pin

4 Nickel Plated Outer  
Link Plates

5 Ring Coin



Selecting the right chain for the job is often overlooked. Harsh conditions where dust / abrasive particles infiltrate moving parts significantly shorten the lifetime of standard chain. This results in high cost caused by downtime, production loss, replacement parts & labour.

The TSUBAKI Titan chain is specially developed to deliver the ultimate wear performance in these harsh conditions. The resulting longer intervals between maintenance / replacement work will notably reduce your Total Cost of Ownership.

## ANTI DUST & ABRASIVES

NEPTUNE  
ANTI  
CORROSION

HEAVY DUTY  
SHOCK  
RESISTANT



LAMBDA  
LUBE FREE

### Typical uses for TSUBAKI Titan chain include:

- Sawmills / wood processing
- Brick / tile manufacturing
- Gypsum board manufacturing
- Mining
- Metal working
- Cement processing
- Sugar processing
- Paper processing

## ANSI HEAVY DUTY ROLLER CHAIN

The superior performance of Tsubaki Heavy Duty chains is the result of a comprehensive quality control network that begins with selection of the world's finest steel materials. It continues with inspection and analysis of quality and performance in 20 different work areas. At Tsubaki quality control is not just a one time check; it is a total dedication. It is your assurance of long lasting and dependable performance.

Tsubaki offers Heavy Duty chains for applications that exceed the capabilities of Tsubaki ANSI G8 standard roller chain. Heavy Duty chain should be considered in the following situations:

1. Harsh environments where the chain will be subjected to heavy impact.
2. Compact drives for equipment or machines that must work in tight spaces.
3. When higher transmission power, allowable load or tensile strength is required.
4. When a lower rate of elastic elongation is required.

### H Series

H Series chain differs only from the ANSI G8 Series chain in the thickness of the link plates. The link plates have the same thickness as the link plates of the next larger pitch size in ANSI G8 Series. The increased thickness of the link plates provides a 10% greater capacity for fatigue strength. In addition, the solid bushes provide twice the wear life on average compared to the previous generation. In short, H Series chains are especially suitable for situations where the load is heavy and operating speed is low (up to 50 m/min) or where operating conditions are severe.

### HT Series

HT Series chain provides a (10% to 20%) higher Tensile Strength than ANSI G8 Series chain by using through-hardened pins and link plates of the next larger pitch size in ANSI G8 series. The solid bushes provide twice the wear life on average compared to the previous generation. HT Series chain also provides a higher fatigue strength and is best suited for low operating speeds - up to 50 m/min. Dimensions of the chain are identical to the H Series chain.

### SUPER Series

The dimensions of these series are identical to those of ANSI G8 Series chain. The special design of the SUPER Series link plate delivers exceptional performance. The pin holes are critically formed and ball drifted and the pins are through-hardened for greater fatigue strength (40%). SUPER Series chains offer 10% higher tensile strength than the equivalent size ANSI G8 Series chain. SUPER Series chains can be used to replace the next larger pitch size of ANSI G8 Series, making them ideal for applications where chain space is limited. Best suited for low

### SUPER-H Series

The thickness of the SUPER-H Series link plates is the same as the next larger pitch size of SUPER Series chain. The pins are also through-hardened which provides a higher tensile strength (12%\*). Higher fatigue strength (15%\*) is achieved by Ring Coining on the inner plates. The pin holes are critically formed and ball drifted. SUPER-H Series chains can be used to replace the next larger size of ANSI standard chain, making them ideal for applications where space is limited. Best suited for low speed operating conditions - up to 50 m/min.

\* Average increase in comparison with the SUPER Series.

### ULTRA SUPER Series

ULTRA SUPER Series offer longer wear life, greater fatigue strength (>60%) and higher tensile strength (>45%) than any other Tsubaki roller chain. The pins are through-hardened and the pin holes are critically formed and ball drifted. This chain is well suited for applications where there are space limitations. The heavy duty construction of the ULTRA SUPER Series chain allows it to replace chains up to two pitch sizes larger ANSI G8 Series chain. It is best suited for low speed operating conditions up to 50 m/min.

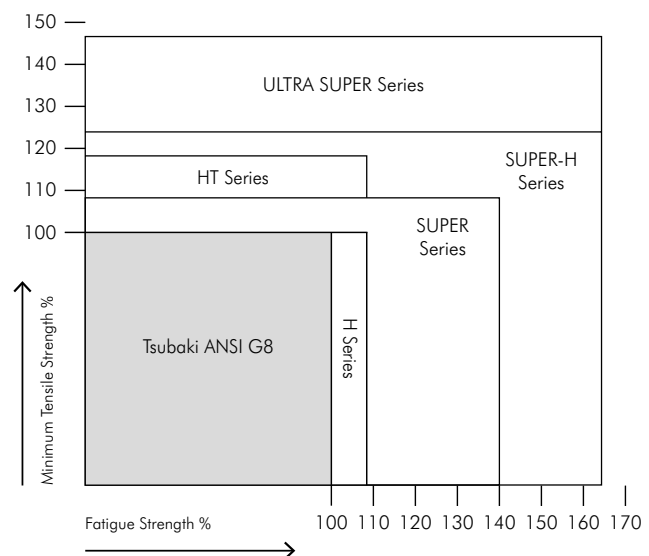

Comparison of Tensile Strength / Fatigue Strength

# HEAVY DUTY

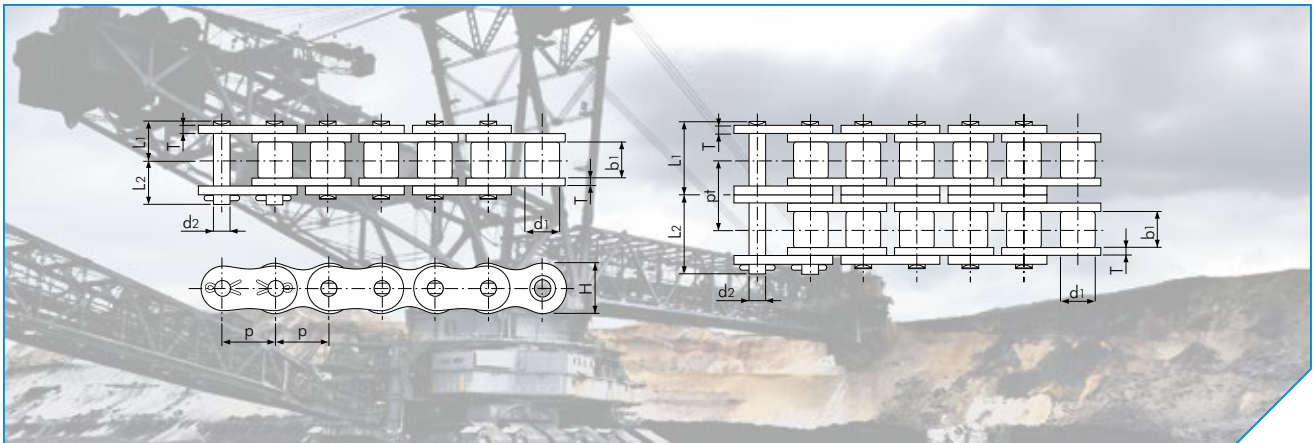

POWER TRANSMISSION

## H Series

Dimensions in mm

TSUBAKI Chain No.	Pitch p	Roller Diameter d1	Inner Width b1	Pin			Link Plate		Transverse Pitch pt	Min. Tensile Strength acc. to TSUBAKI kN	Approx. Mass kg/m
				Diameter d2	Length L1	Length L2	Thickness T	Height H (max)			
RS60-H1	19.05 (3/4")	11.91	12.70	5.96	14.80	17.00	3.20	18.10	-	40.2	1.80
RS60-H2					27.80	29.90			26.10	80.4	3.59
RS80-H1	25.40 (1")	15.88	15.88	7.94	18.30	20.90	4.00	24.10	-	71.6	3.11
RS80-H2					34.60	37.20			32.60	143.0	6.18
RS100-H1	31.75 (1 1/4")	19.05	19.05	9.54	21.80	24.50	4.80	30.10	-	107.0	4.58
RS100-H2					41.40	44.10			39.10	214.0	9.03
RS120-H1	38.10 (1 1/2")	22.23	25.40	11.11	26.95	30.55	5.60	36.20	-	148.0	6.53
RS120-H2					51.40	55.00			48.90	296.0	12.90
RS140-H1	44.45 (1 3/4")	25.40	25.40	12.71	28.90	33.10	6.40	42.20	-	193.0	8.27
RS140-H2					55.00	59.50			52.20	386.0	16.38
RS160-H1	50.80 (2")	28.58	31.75	14.29	33.95	38.45	7.15	48.20	-	255.0	10.97
RS160-H2					64.90	69.60			61.90	510.0	21.78
RS200-H1	63.50 (2 1/2")	39.68	38.10	19.85	42.90	48.10	9.50	60.30	-	427.0	18.41

## SUPER Series

Dimensions in mm

TSUBAKI Chain No.	Pitch p	Roller Diameter d1	Inner Width b1	Pin			Link Plate		Transverse Pitch pt	Min. Tensile Strength acc. to TSUBAKI kN	Av. Tensile Strength acc. to TSUBAKI kN	Approx. Mass kg/m	
				Diameter d2	Length L1	Length L2	Length L	Thickness T					Height H (max)
RS80-SUP-1	25.40 (1")	15.88	15.88	7.94	16.25	19.25	39.30	3.20	24.10	-	74.2	85.3	2.81
RS80-SUP-2					30.90	33.90	-			29.30	148.0	171.0	5.62
RS100-SUP-1	31.75 (1 1/4")	19.05	19.05	9.54	19.75	22.85	48.00	4.00	30.10	-	111.0	127.0	4.25
RS100-SUP-2					37.70	40.80	-			35.80	222.0	255.0	8.38
RS120-SUP-1	38.10 (1 1/2")	22.23	25.40	11.11	24.90	28.90	59.90	4.80	36.20	-	162.0	186.0	6.30
RS120-SUP-2					47.60	51.60	-			45.40	324.0	373.0	12.44
RS140-SUP-1	44.45 (1 3/4")	25.40	25.40	12.71	26.90	31.70	65.70	5.60	42.20	-	213.0	245.0	8.04
RS160-SUP-1	50.80 (2")	28.58	31.75	14.29	31.85	36.85	77.20	6.40	48.20	-	273.0	314.0	10.79
RS200-SUP-1	63.50 (2 1/2")	39.68	38.10	19.85	39.00	44.80	94.90	8.00	60.30	-	439.0	505.0	17.63
RS240-SUP-1	76.20 (3")	47.63	47.63	23.81	47.90	55.50	116.00	9.50	72.40	-	639.0	735.0	25.63



## CHAIN FOR CORROSIVE ENVIRONMENTS

Whether your operation requires a sanitary environment, is exposed to corrosive chemicals, is heated to extreme temperatures, runs through a freezer, is exposed to the outdoors or is affected by excessive moisture: our specially designed and tested chains will outlast your current chains and contribute to a cost effective application.

### Corrosion Resistant Chain (Stainless Steel base)

#### BS PC Engineering Plastic Combination Chain

The pins and pin link plates of these chains are made of SUS304 equivalent (spring clips SUS301). Engineering plastic (white) is used for the inner link. This combination makes it a lube-free, low noise (5 dB lower than BS standard roller chain) and lightweight chain (50% lighter than BS standard roller chain). Working temperature range: -20°C to +80°C.

For details on corrosion resistance, please check out the table in the back of this catalogue.

#### BS SS Stainless Steel Chain

All basic components of this chain are made of Stainless Steel SUS304 equivalent (except the spring clips, which are made of SUS301). This chain can be used in special environments such as underwater, acidic and alkaline applications. It can also be used in high and low temperatures (-20°C to +400°C). SUS304 equivalent is only marginally magnetic, which is the result of the cold-forging process. For details on corrosion resistance, please check out the table in the back of this catalogue.

### Corrosion Protected Chain (Carbon Steel base)

#### BS NEPTUNE™ Surface Treated Chain

BS NEPTUNE™ Chain is a TSUBAKI BS chain that has undergone a special surface treatment.

The link plates, bushes and bearing pins have a special three stage layer applied in order to provide the maximum protection from the operating or environmental conditions. (Spring clips are SUS301). NEPTUNE™ Rollers have a special coating designed to resist the corrosive conditions as well as the severe dynamic contact between roller and sprocket.

This chain is suitable for use in environments exposed to sea-water, acid-rain and other adverse weather conditions. This chain does not contain any chemically hazardous substances such as Hexavalent Chromium, Lead, Cadmium and Mercury as regulated by RoHSV. The kilowatt ratings are the same as those of the corresponding BS chain with a working temperature range: -10°C to +150°C. Above +60°C a special high-temperature lubrication is required. Of course, BS LAMBDA NEPTUNE™ chain is also available.

#### BS NP Nickel Plated Chain

BS NP Chain is a TSUBAKI BS chain that has been plated with Nickel. NP Chain has a light corrosion resistance and an attractive appearance. NP Chain is suitable for outdoor conditions exposed to water. There is a 15% reduction in Maximum Allowable Load compared to the corresponding BS chain, so please take this into account when making your chain selection. It has a working temperature range of: -10°C to +60°C. Of course, BS LAMBDA NP chain is also available.

√ RoHS = Restriction of Hazardous Substances

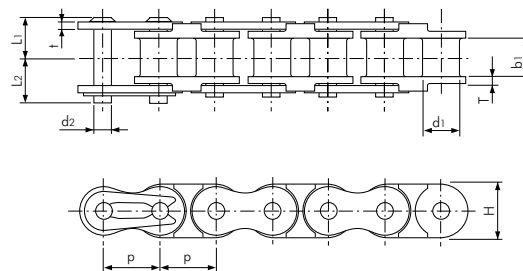

## PC Chain

Dimensions in mm

TSUBAKI Chain No.	Pitch p	Bush Diameter d1	Inner Width b1	Pin			Link Plate			Max. Allowable load acc. to TSUBAKI kN	Approx. Mass kg/m
				Diameter d2	Length L1	Length L2	Thickness T	Thickness t	Height H (max)		
RF06B-PC-1	9.525 (3/8")	6.35	5.72	3.28	6.50	7.25	1.30	1.00	8.20	0.20	0.23
RS08B-PC-1	12.70 (1/2")	8.51	7.75	4.45	8.35	10.05	1.60	1.50	12.00	0.46	0.40
RS10B-PC-1	15.875 (5/8")	10.16	9.65	5.08	9.55	11.25	1.50	1.50	14.70	0.53	0.51
RS12B-PC-1	19.05 (3/4")	12.07	11.68	5.72	11.10	13.00	1.80	1.80	16.10	0.70	0.67

PC CHAIN

NEPTUNE™

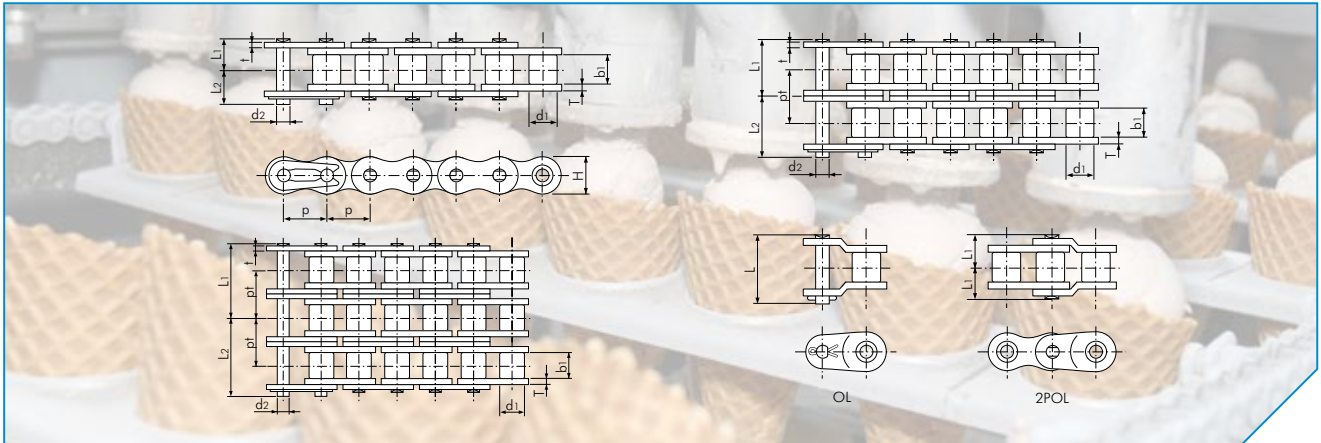

POWER TRANSMISSION

SS Chain

Dimensions in mm

TSUBAKI Chain No.	Pitch p	Roller Diameter d1	Inner Width b1	Pin			Link Plate			Transverse Pitch pt	Max. Allowable Load acc. to TSUBAKI kN	Approx. Mass kg/m	
				Diameter d2	Length L1	Length L2	Length L	Thickness T	Thickness t				Height H (max)
RF06B-SS-1	9.525 (3/8")	6.35	5.72	3.28	6.50	7.25	15.45	1.30	1.00	8.20	-	0.27	0.39
RF06B-SS-2					11.60	12.30	25.85				10.24	0.53	0.75
RS08B-SS-1	12.70 (1/2")	8.51	7.75	4.45	8.35	10.05	20.05	1.50	1.50	11.80	-	0.48	0.70
RS08B-SS-2					15.30	17.00	34.60				13.92	0.96	1.35
RS08B-SS-3					22.25	23.95	48.60				13.92	1.44	2.00
RS10B-SS-1	15.875 (5/8")	10.16	9.65	5.08	9.55	11.25	22.90	1.50	1.50	14.70	-	0.66	0.95
RS10B-SS-2					17.85	19.55	39.40				16.59	1.32	1.85
RS10B-SS-3					26.20	27.80	56.00				16.59	1.97	2.80
RS12B-SS-1	19.05 (3/4")	12.07	11.68	5.72	11.10	13.00	26.70	1.80	1.80	16.10	-	0.87	1.25
RS12B-SS-2					20.90	22.70	46.10				19.46	1.74	2.50
RS12B-SS-3					30.65	32.55	65.60				19.46	2.62	3.80
RS16B-SS-1	25.40 (1")	15.88	17.02	8.28	17.75	19.95	43.70	4.00	3.20	21.00	-	2.06	2.70
RS16B-SS-2					33.55	35.75	75.50				31.88	4.12	5.40
RS20B-SS-1	31.75 (1 1/4")	19.05	19.56	10.19	20.10	23.20	48.40	4.50	3.50	26.00	-	2.84	3.85

NEPTUNE™ Chain

Dimensions in mm

TSUBAKI Chain No.	Pitch p	Roller Diameter d1	Inner Width b1	Pin			Link Plate			Transverse Pitch pt	Min. Tensile Strength acc. to ISO 606 kN	Approx. Mass kg/m	
				Diameter d2	Length L1	Length L2	Length L	Thickness T	Thickness t				Height H (max)
RS08B-IM-NEP-1	12.70 (1/2")	8.51	7.75	4.45	8.40	10.00	18.60	1.60	1.60	11.80	-	17.8	0.70
RS08B-IM-NEP-2					15.30	16.90	34.50				13.92	31.1	1.35
RS10B-IM-NEP-1	15.875 (5/8")	10.16	9.65	5.08	9.55	11.25	20.80	1.50	1.50	14.70	-	22.2	0.95
RS10B-IM-NEP-2					17.85	19.55	39.40				16.59	44.5	1.85
RS12B-IM-NEP-1	19.05 (3/4")	12.07	11.68	5.72	11.10	13.00	24.40	1.80	1.80	16.10	-	28.9	1.25
RS12B-IM-NEP-2					20.85	22.75	45.90				19.46	57.8	2.50
RS16B-IM-NEP-1	25.40 (1")	15.88	17.02	8.28	17.75	19.95	41.10	4.00	3.20	21.00	-	60.0	2.70
RS16B-IM-NEP-2					33.55	35.75	75.20				31.88	106.0	5.40
RS20B-IM-NEP-1	31.75 (1 1/4")	19.05	19.56	10.19	19.90	23.10	46.60	4.40	3.40	26.40	-	95.0	3.85
RS24B-IM-NEP-1	38.10 (1 1/2")	25.40	25.40	14.63	26.65	31.85	61.70	6.00	5.60	33.40	-	160.0	7.45

## CHAIN WITH ATTACHMENTS

In the world of attachment chain TSUBAKI is the manufacturer you require to assure smooth operation. Whether your application requires attachments or extended pins in Carbon Steel, Neptune™, Nickel Plating or Stainless Steel, TSUBAKI is your partner. TSUBAKI's maintenance free solution, LAMBDA, is also available with a wide range of attachments. When starting with a completely new design, TSUBAKI can tailor make an attachment chain for you in any specification.



GT4 WINNER WITH  
**BENT ATTACHMENTS**



LAMBDA WITH  
**BENT ATTACHMENTS**



NEPTUNE WITH  
**STRAIGHT ATTACHMENTS**



PC WITH  
**EXTENDED PINS**



LAMBDA FOR  
**CHOCOLATE MOULDING**



NP/SS FOR  
**FILM GRIPPING**

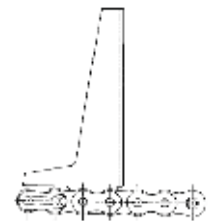

LAMBDA FOR  
**CARTONING**

## MATCH & TAG

When even more accurate tolerances are required, TSUBAKI can offer an effective solution with the Match & Tag Service. This can be useful for attachment chains which have to run parallel in pairs and where a minimum of chain length tolerance is required.

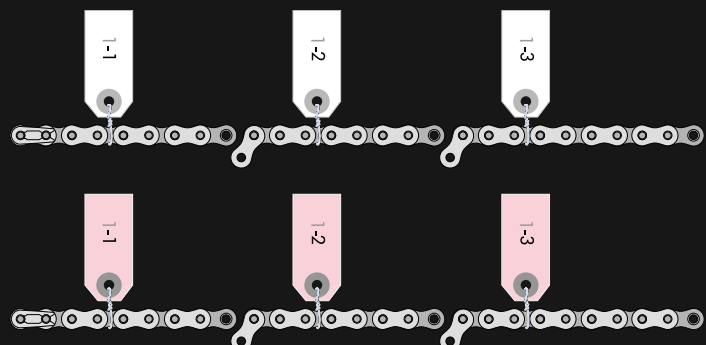

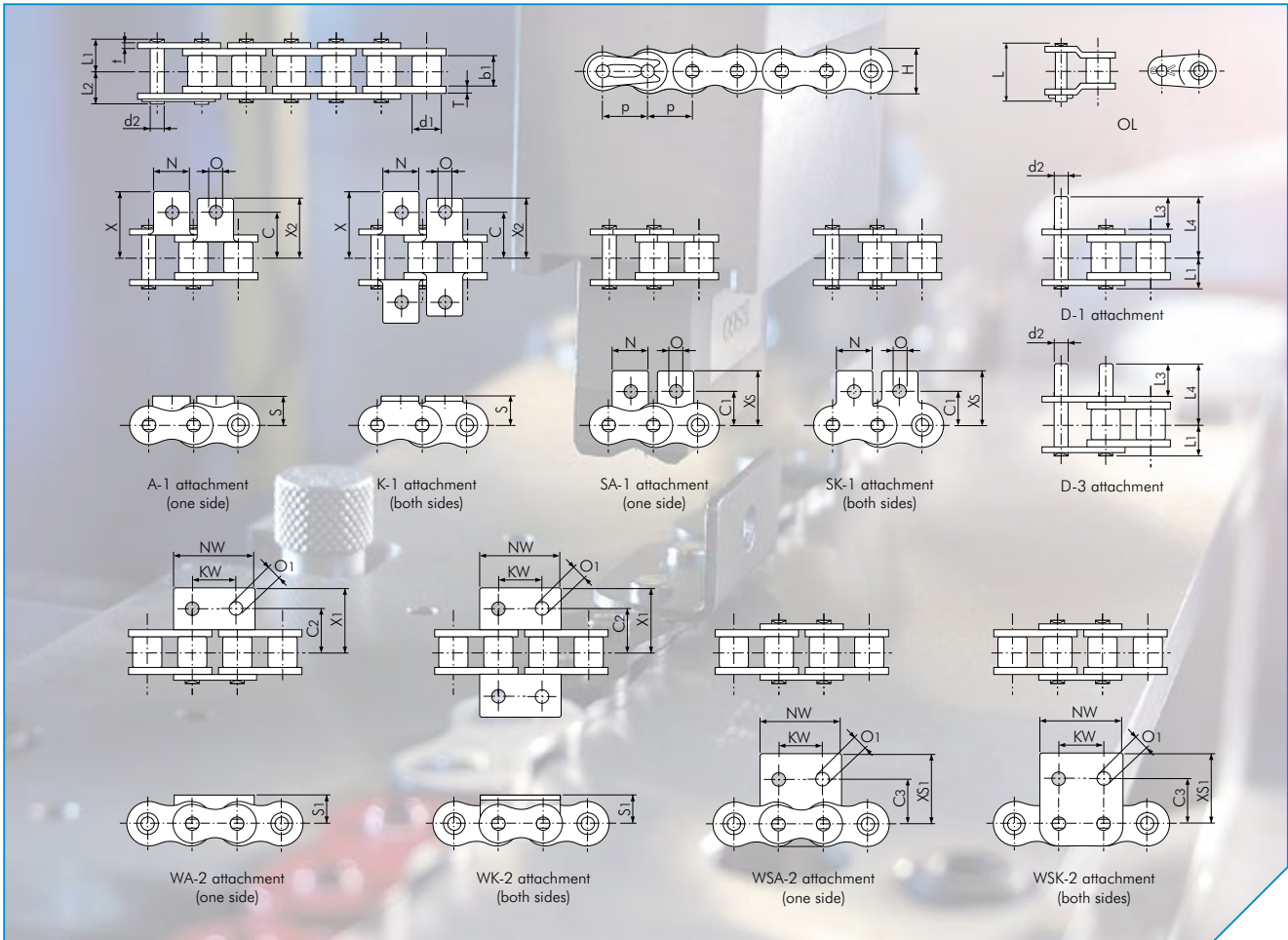

## Single Pitch Standard Chain

Dimensions in mm

TSUBAKI Chain No.	Pitch p	Roller Diameter d1	Inner Width b1	Pin						Link Plate			Approx. Mass kg/m
				Diameter d2	Length L1	Length L2	Length L3	Length L4	Length L	Thickness T	Thickness t	Height H (max.)	
RF06B	9.525 (3/8")	6.35	5.72	3.27	6.10	7.70	10.90	16.30	15.10	1.30	1.00	8.20	0.39
RS08B	12.70 (1/2")	8.51	7.75	4.45	8.40	10.00	14.70	22.20	18.60	1.60	1.60	11.80	0.70
RS10B	15.875 (5/8")	10.16	9.65	5.08	9.55	11.25	17.80	26.15	20.80	1.50	1.50	14.70	0.95
RS12B	19.05 (3/4")	12.07	11.68	5.72	11.10	13.00	20.80	30.60	24.40	1.80	1.80	16.10	1.25
RS16B	25.40 (1")	15.88	17.02	8.28	17.75	19.95	33.20	49.35	41.10	4.00	3.20	21.00	2.70
RS20B	31.75 (1 1/4")	19.05	19.56	10.19	19.90	23.10	38.40	56.90	46.60	4.40	3.40	26.00	3.85

TSUBAKI Chain No.	Attachment Dimensions															Attachment Mass						
	C	C1	C2	C3	KW	N	NW	O	O1	S	S1	X	X1	X2	XS	XS1	A SA	K SK	WA WSA	WK WSK	Ext. Pin	
RF06B	9.50	9.50	-	-	-	8.50	-	3.50	-	6.5	-	14.10	-	-	14.30	-	0.002	0.004	-	-	-	0.001
RS08B	11.90	12.70	12.70	13.10	12.70	11.40	24.60	4.20	4.90	8.90	8.90	19.05	20.30	17.15	19.30	20.70	0.002	0.004	0.005	0.010	0.001	0.001
RS10B	15.90	15.90	15.90	16.60	15.90	12.70	30.00	5.00	5.00	10.20	10.20	22.25	22.85	20.60	22.90	23.60	0.003	0.006	0.006	0.012	0.002	0.002
RS12B	19.05	22.20	17.45	17.60	19.10	16.50	34.80	7.10	5.50	13.50	11.40	29.85	25.65	27.80	32.05	25.75	0.006	0.012	0.009	0.018	0.003	0.003
RS16B	23.80	23.90	28.60	26.00	25.40	24.30	46.00	6.70	8.10	15.20	15.90	37.35	39.25	34.40	34.10	36.70	0.014	0.028	0.030	0.060	0.008	0.008
RS20B	31.75	31.80	-	-	-	25.40	-	8.70	-	19.80	-	44.85	-	-	44.00	-	0.027	0.054	-	-	-	0.014

Note:  
1. RF06B chain has flat-shaped link plates.

## TSUBAKI SPROCKET SOLUTIONS

TSUBAKI now offers a big range of high quality sprockets. Our sprockets are built from top-grade, heat-treated carbon steel to offer long wear life, resist abrasion, and withstand heavy shock loads. You get longer service life and reliable performance, turn after turn, time after time.

For extra corrosion resistance and food-grade applications, alloy and stainless steel sprockets are also available.

### Sprocket Performance

System performance highly depends on chain-sprocket interaction, which means your choice of sprockets can elevate your operation's success. Make the right and easy choice with sprockets from TSUBAKI.

- Reduced downtime maintenance
- Increased productivity
- Lower replacement costs

### Stock Line Up

In order to serve the majority of the sprocket market, Tsubakimoto Europe has stocked a vast range of sprockets.

- Carbon Steel sprockets acc. DIN 8187 standard (Simplex & Duplex)
- Stainless Steel sprockets acc. DIN 8187 standard (Simplex)
- Carbon Steel sprockets acc. ANSI standard (Simplex)
- Carbon Steel Taper Bore sprockets acc. DIN 8187 standard (Simplex)
- Taper Bushes, metric series

To ensure maximum performance of your drive system, TSUBAKI carbon steel sprockets are executed with induction hardened teeth as a standard to make a perfect match with the high quality TSUBAKI chains.

### Special Sprockets

To enjoy the advantage of the availability of customized sprockets according to customer drawings, special agreements can be made to have stock available in our warehouse. This way you are able to reduce your stock and increase delivery performance as well as production efficiency. Please contact our Sales Department for further details.



“We offer a complete line of standard and customized sprockets!”

### Design Features

TSUBAKI has selected specific design features to realize the maximum performance from your power transmission as well as your logistics handling system:

#### Hardened Teeth

All stocked carbon steel sprockets are executed with induction hardened teeth to achieve maximum wear life of both sprockets and chain.

**Hardness range:** 40 - 55 HRC

**Hardness depth:** 0,5 - 1,5 mm

#### Materials

Our sprocket range is available from stock in high quality steels:

**Carbon steel** (single piece type: C45, welded hub type: C20/Q235)

**Stainless steel** (AISI 304)

#### TSUBAKI Box

To help you reduce your handling cost, all TSUBAKI sprockets are packed in TSUBAKI boxes. Boxed packaging make the handling and storage of sprockets more efficient.

Each carbon steel sprocket is protected with a layer of rust preventive oil and is wrapped in a plastic cover inside the TSUBAKI box.

#### Bar Coding

Besides the use of a TSUBAKI box, also bar coding is applied reducing your handling cost even more.

## MADE TO ORDER SPROCKETS



TSUBAKI has designed and manufactured made-to-order (MTO) sprockets since more than 60 years.



Extensive design, engineering and manufacturing capabilities allow TSUBAKI to produce a wide variety of MTO sprocket products for a multitude of applications. Our capabilities include CNC machining for special tooth profiles, in-house heat

treatment and a variety of product finishes. Our CAD design capabilities allow us to provide highly customized solutions for almost every application.

POWER  
TRANSMISSION

### Wear Indicator

TSUBAKI Sprocket Wear Indicator Technology assures maximum uptime and drive system efficiency by providing visual confirmation of excessive sprocket wear. Incorporating this patented technology into MTO, ANSI, or Engineering Class sprockets reduces overall system cost by offering predictable maintenance intervals to avoid catastrophic failure.

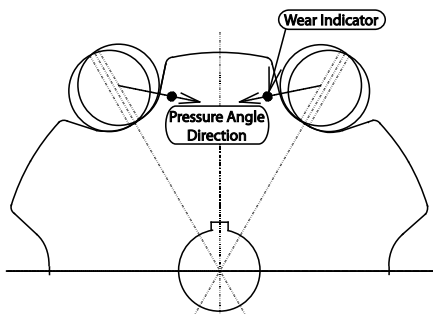

### Segmental rim and hubs

Segmental rims are designed to save time and money by reducing costly downtime. The rims can be replaced without having to remove shaft and bearings.

## CAM CLUTCH - FREEWHEEL

TSUBAKI offers the most complete and versatile selection of one-way clutches in the global industry. Cam Clutches are precision devices which lock the inner- and outer races, through a wedging action of cams, to transmit torque in one direction of rotation and overrun in the opposite direction. These units are often referred to as freewheels, sprag clutches, overrunning clutches, backstops or one-way clutches, depending upon on the application for which they are used.

### Design Features

#### Full Cam Complement

The full complement of cams provides the maximum number of load transmitting members per given diameter. The result is a higher torque capacity than other clutches.

#### Cam Design

Precision formed cams, made of special alloy steel assure extra long wear- and fatigue life.

#### High Quality Components

Outer- and inner races are made of high-quality alloy steel with high surface hardness and core toughness. The races are precision ground, providing excellent concentricity and surface finish to obtain accurate cam rotation.

#### BB, BB1K, BB2K SERIES

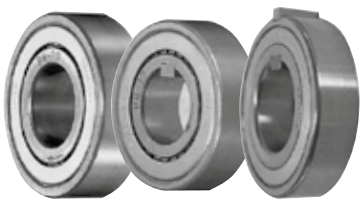

BB Series Cam Clutch Freewheels with shields have bearing characteristics and dimensions of type 62 ball bearings. Press fit, single inner race keywayed (1K) and inner and outer race keywayed (2K) versions available. Keys for inner and outer race also available.

**Bore sizes** - 15, 17, 20, 25, 30, 35, 40mm  
**Maximum torque** - 260Nm

#### BR-HT SERIES



BR-HT centrifugal lift off Cam Clutch series Backstops are designed for high speed backstopping operations with higher torque requirements. The BR-HT Series is an open type design for directly into machinery such as gear reducers, pumps and winches.

**41 Clutch sizes**  
**Bore range** - 20-320mm  
**Maximum torque** - 366000Nm

#### BSEU / BSEU 2GD SERIES



BSEU Series are pre-lubricated European style Cam Clutches designed primarily for backstopping operations. The BSEU has an integral torque arm on the outer race and is fitted with high performance V-ring seals. The BSEU Series is fitted TSUBAKI's unique self-lubricating cam/roller mechanism for longer life. The BSEU 2GD Series is fitted with a lip seal and outer cover for enhanced dust and spray protection.

**4 Clutch sizes**  
**Bore sizes** - 20, 25, 30, 35, 40, 45, 50, 55, 60, 65, 70, 75, 80, 90mm  
**Maximum torque** - 4700Nm

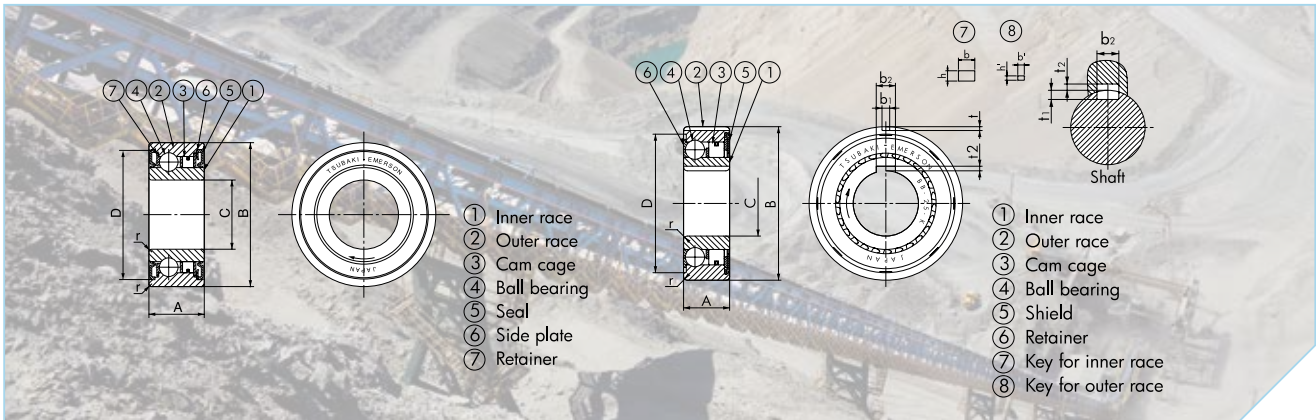

POWER TRANSMISSION

## BB, BB-1K-K, BB-2K-K, BB-2GD, BB-2GD 1K-K

Dimensions in mm

Model	Torque Capacity Nm	Max. Overrunning Speed		Drag Torque Nm		A		B	C	D		r	Bearing Loads		Approx. Mass g/pc	
		Inner Race r/min	Outer Race r/min	BB BB-1K-K BB-2K-K	BB-2GD BB-2GD 1K-K	BB BB-1K-K BB-2K-K	BB-2GD BB-2GD 1K-K			BB BB-1K-K BB-2K-K	BB-2GD BB-2GD 1K-K		C	Co	BB BB-1K-K BB-2K-K	BB-2GD BB-2GD 1K-K
BB15	29	3600	2000	0.010	0.040	11	16	35	15	32.6	32.45	0.6	5950	3230	50	70
BB17	43	3500	1900	0.010	0.050	12	17	40	17	36.1	36.45	0.6	7000	3700	80	100
BB20	61	3000	1600	0.014	0.055	14	19	47	20	41.7	42.35	1.0	8500	4900	120	150
BB25	78	2500	1400	0.017	0.055	15	20	52	25	47.1	47.05	1.0	10700	6300	150	200
BB30	140	2000	1100	0.030	0.058	16	21	62	30	56.6	55.60	1.0	11900	7900	230	280
BB35	173	1800	1000	0.034	0.060	17	22	72	35	64.0	64.60	1.1	13500	9700	320	410
BB40	260	1800	900	0.040	0.080	22	27	80	40	71.0	71.60	1.1	14500	11700	400	600

Model	Shaft Diameter	Housing Diameter	Model	Shaft Diameter	Housing Diameter	Model	Shaft Diameter	Housing Diameter		
BB15	BB15-2GD	15 +0.023 / +0.012	35 -0.012 / -0.028	BB15-1KK	BB15-2GD 1KK	15 -0.008 / -0.028	35 -0.012 / -0.028	BB15-2KK	15 -0.008 / -0.028	35 -0.002 / -0.018
BB17	BB17-2GD	17 +0.023 / +0.012	40 -0.012 / -0.028	BB17-1KK	BB17-2GD 1KK	17 -0.008 / -0.028	40 -0.012 / -0.028	BB17-2KK	17 -0.008 / -0.028	40 -0.002 / -0.018
BB20	BB20-2GD	20 +0.028 / +0.015	47 -0.012 / -0.028	BB20-1KK	BB20-2GD 1KK	20 -0.010 / -0.031	47 -0.012 / -0.028	BB20-2KK	20 -0.010 / -0.031	47 -0.003 / -0.022
BB25	BB25-2GD	25 +0.028 / +0.015	52 -0.014 / -0.033	BB25-1KK	BB25-2GD 1KK	25 -0.010 / -0.031	52 -0.014 / 0.033	BB25-2KK	25 -0.010 / -0.031	52 -0.003 / -0.022
BB30	BB30-2GD	30 +0.028 / +0.015	62 -0.014 / -0.033	BB30-1KK	BB30-2GD 1KK	30 -0.010 / -0.031	62 -0.014 / -0.033	BB30-2KK	30 -0.010 / -0.031	62 -0.003 / -0.022
BB35	BB35-2GD	35 +0.033 / +0.017	72 -0.014 / -0.033	BB35-1KK	BB35-2GD 1KK	35 -0.012 / -0.037	72 -0.014 / -0.033	BB35-2KK	35 -0.012 / -0.037	72 -0.006 / -0.025
BB40	BB40-2GD	40 +0.033 / +0.017	80 -0.014 / -0.033	BB40-1KK	BB40-2GD 1KK	40 -0.012 / -0.037	80 -0.014 / -0.033	BB40-2KK	40 -0.012 / -0.037	80 -0.006 / -0.025

Model	Keyway	Inner Race Key		Outer Race Key	
		b x h x length	b' x h' x length		
BB15-1KK	BB15-2GD 1KK	5.0	1.9	1.2	-
BB15-2KK	-	5.0	1.9	1.2	2.0
BB17-1KK	BB17-2GD 1KK	5.0	1.9	1.2	2.0
BB17-2KK	-	5.0	1.9	1.2	2.0
BB20-1KK	BB20-2GD 1KK	6.0	2.5	1.6	3.0
BB20-2KK	-	6.0	2.5	1.6	3.0
BB25-1KK	BB25-2GD 1KK	8.0	3.6	1.5	6.0
BB25-2KK	-	8.0	3.6	1.5	6.0
BB30-1KK	BB30-2GD 1KK	8.0	3.1	2.0	6.0
BB30-2KK	-	8.0	3.1	2.0	6.0
BB35-1KK	BB35-2GD 1KK	10.0	3.7	2.4	8.0
BB35-2KK	-	10.0	3.7	2.4	8.0
BB40-1KK	BB40-2GD 1KK	12.0	5.0	3.3	10.0
BB40-2KK	-	12.0	5.0	3.3	10.0

**Note:**

For BB25-1KK, BB25-2KK and BB25-2GD 1KK the dimension of t2 is 0.5 mm shallower than DIN 6885.3. To use a DIN standard key, process the keyway 0.5 mm deeper on the shaft than according to DIN standard. All other models are dimensionally interchangeable.



## TSUBAKI CHAIN WEAR INDICATOR



### CONTENT



#### **BS Set**

*(Art. no. 2017031680)*

- Chain Wear Indicator in sizes RFO6B to RS16B
- Chain Identifier for BS & ANSI chain
- Instructions on how to use

#### **ANSI Set**

*(Art. no. 2017031681)*

- Chain Wear Indicator in sizes RS35 to RS80
- Chain Identifier for BS & ANSI chain
- Instructions on how to use



#### **BS Large Size Indicator**

- Available in sizes RS20B to RS56B
- Each size sold separately in leatherette pouch

#### **ANSI Large Size Indicator**

- Available in sizes RS100 to RS240
- Each size sold separately in leatherette pouch

# MEASURE WEAR

The TSUBAKI Chain Wear Indicator is designed to measure roller chain condition and determine critical wear. The gauges are made of quality material and are resistant to corrosion. Their robust construction ensures accurate measuring everytime.

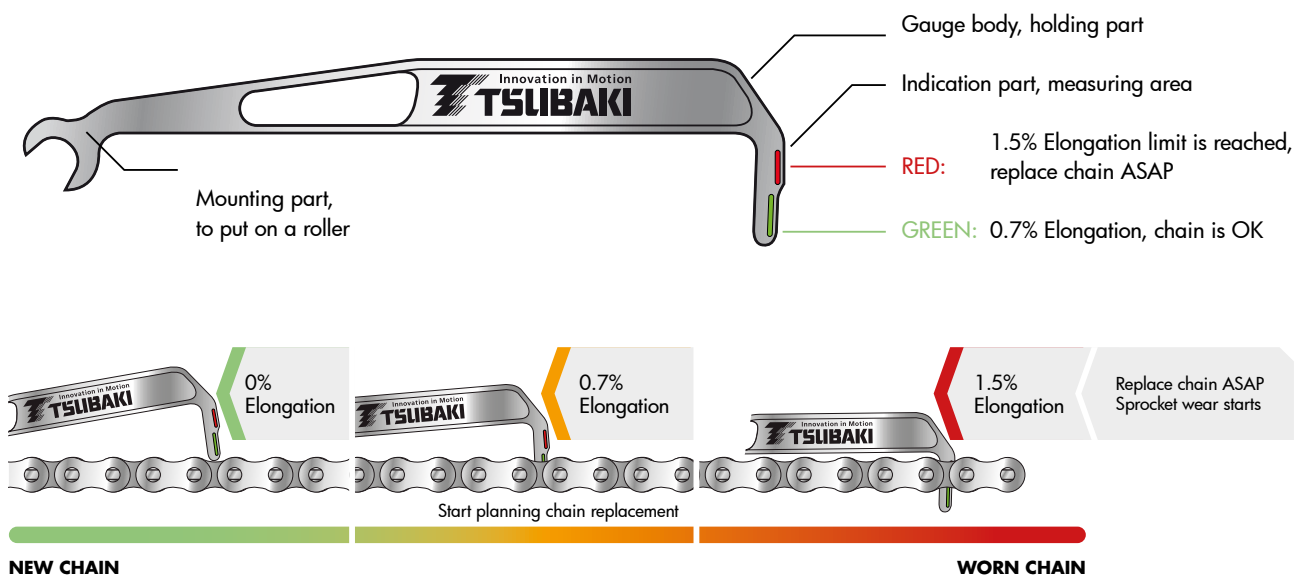

## TSUBAKI RECOMMENDATION:

- Use the Chain Wear Indicator according to your regular maintenance schedule of the machine or production line.
- Always measure on several points - do not be satisfied with one measurement, since the chain might wear unevenly.
- Regularly checking the chain for wear allows for better management of maintenance scheduling and eliminates the risk of chain breakage.
- Replacing chains before reaching 1.5% elongation will prevent significant sprocket wear, thus averting costly downtime.

For more information, please visit [www.tsubaki.eu](http://www.tsubaki.eu)



Power Transmission Solutions

# Roller Chains from Cross+Morse

POWER TRANSMISSION

## Standard Chains



Cross+Morse produce only high-performance roller chain of consistent quality as an ISO 9001:2015 company, using modern manufacturing technology combined with long established proven specifications to give long service life.

- **B.S. 3/8" to 2.1/2" pitch chains, simplex, duplex & triplex. ANSI 25 to 200.**
- **Straight sideplate simplex & duplex, Hollow pin chain, Double pitch BS chain.**
- **Short delivery lead times, free chain cutting service.**
- **Easy disassembly as pins produced using a copper plating process on BS chain 1/2" and over.**

## Special Attachment Chains



K and M plates and extended pins

We have a large range of attachments for standard roller chains, including 304 stainless steel chain components.

- **Standard K1, K2 and M1, M2 plates manufactured**
- **Extended pins manufactured on site**
- **Matched lengths stress tested**

# Roller Chains from Cross+Morse



Power Transmission Solutions

## Chain with special attachments

Cross+Morse chain systems are supplied to the food, packaging and processing industries as it provides unfailing operation throughout lengthy production cycles, 24 hours a day. Suitable for new or retrofit installation.

Custom designed attachments manufactured, both as individual components and as chain assemblies

- **Suitable for the food, drink and packaging sectors**
- **In feed, cross feed, powerbend and side guide chains supplied**
- **Chocolate moulding chain with special attachments**



## Inverted Tooth Chains

Inverted tooth chains provide a concept for the transmission of high torque combined with high shaft speeds, resulting in smooth running and quiet drives transmitting up to 4,000 kW with shaft speed to 12,000 rpm.

- **HC Hy-Vo 63-139 – 3/8" to 1"**
- **HC Hy-Vo 61-115 – 1.1/2 to 2"**
- **SC Series Inverted Tooth Chains 3/16" to 2" pitch**
- **HC + SC Sprockets manufactured in house to suit chain**





Power Transmission Solutions

## Roller Chains from Cross+Morse

### Stainless Steel & Corrosion Resistant Roller Chains

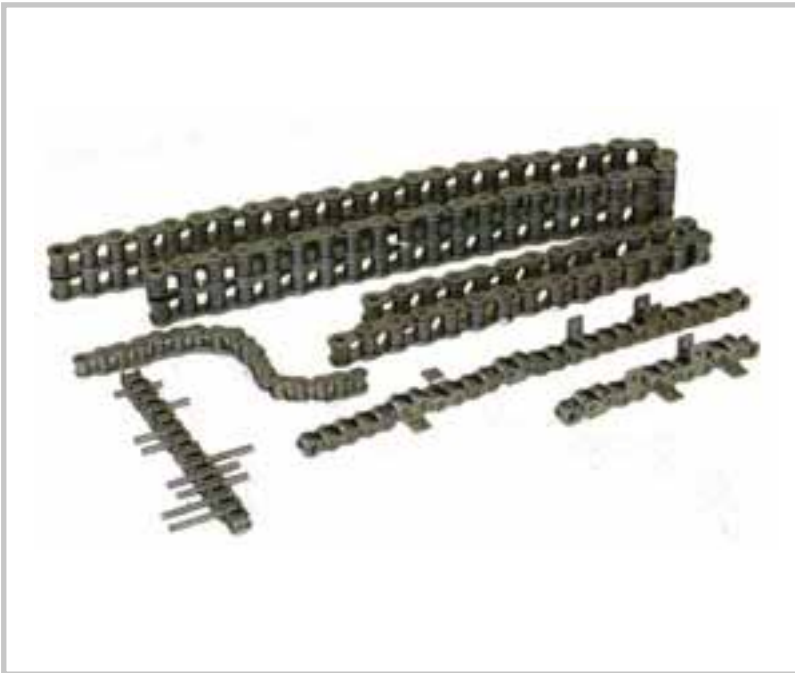

Standard stainless steel chains are manufactured in both 304 and 316 grade steels for high corrosion resistance. Especially suited to environments where water, acids, chemicals, high humidity and extremes of temperature are encountered.

- **B.S. 6mm to 1¼" pitch simplex & duplex - SS304**
- **B.S. 8mm to 1" pitch simplex – SS316**
- **ANSI standard from ¼" to 1" in simplex**
- **Simplex chains also available Nickel plated or Aquaproofed**

# Cross+Morse Overload Protection



Power Transmission Solutions

## Torque Limiters

POWER  
TRANSMISSION

Morse Torque Limiter is a protection device that limits torque transmitted in a drive, by slipping when the torque exceeds a preset value, due to shock loads, overloads, or machine jams. It automatically re-engages when the overload has passed.

- **Simple Design • Easy Adjustment • Wide Torque Adjustment • Compact**
- **Minimum Maintenance • Economical • Dependable**
- **Stocked in both pilot bore and pre-bored to popular sizes to give prompt delivery**
- **Manufactured by Cross+Morse in Birmingham. England**



## Cross Sheargard Clutch

Cross Sheargard Clutch uses a unique shaped wedge pin to provide overload protection. Designed to accept standard torque limiter platewheels and roller chain couplings.

- **Sheargard clutches provide a torque range from 27 to 16,700Nm, larger standard units made to order with torque capacities up to 69,700Nm**
- **Optional sensor plate to trigger a limit switch to isolate the drive**
- **Wedge pins are available in both steel and brass.**
- **Brass wedge pin generates no spark when broken.**





Power Transmission Solutions

# Cross+Morse Overload Protection

POWER  
TRANSMISSION

## Crossgard



Crossgard series of overload clutches use random positioned sprung loaded balls locked in detents to provide drive and overload control. 3 types are offered, all with optional Flexible Shaft Couplings

- **Type CG - Low cost, simple design for general purpose applications: torque range (10-7154Nm) with operating speeds up to 700 rpm.**
- **Type CGX - Unique design provides zero backlash drives; torque range 1.7-785Nm and maximum speed 1,400 rpm**
- **Type CGZ - High speed (up to 1800 rpm) overload clutch, with total drive disengagement: torque range 2.4-450Nm**

## Safeguard Overload Clutches



Safeguard overload clutches are designed to be fully interchangeable with other European manufacturers. Using a number of balls on unsynchronized units, and random positioned rollers on synchronized units, enables high torques and operating speeds to be achieved.

- **Units available are CSF, CSY, CSL, CSZ, CZF, CZY,**
- **Synchronous & non-synchronous design available**
- **Zero backlash on some units**
- **CZP – Pneumatically operated to enable torque**
- **Adjustment whilst machine is running**

# Roller Chain Couplings from Cross+Morse



Power Transmission Solutions

## LRC Duplex Roller Chain Couplings

Cross & Morse Roller Chain Couplings consist of three high strength components; two special chain sprockets manufactured from high quality medium carbon alloy steels connected by a length of high strength Duplex Roller Chain.

- **Sprockets have precision cut teeth, induction hardened for maximum service life**
- **Available either plain bore or machined for taper bores**
- **Low to medium speed drives (to 2,000rpm)**



## LNC DELRIN® Chain Couplings

Morse Delrin® Chain Couplings for Applications up to 5000 rpm and from fractional to 45Kw. Available in two series N400 ½" pitch & N600 ¾" pitch.

- **Medium speed drives (to 5,000 rpm)**
- **Corrosion proof chain**
- **Suitable for textile and food processing machines**
- **Available with minimum plain bore, finished bore with standard keyway and setscrew, or taper bore**



Delrin® is a registered trademark of DuPont





Power Transmission Solutions

## Cross+Morse Sprockets, Gears, Specials & Rework

POWER TRANSMISSION

### Sprockets & Platewheels



Cross+Morse carry an extensive stock range of low cost pilot bored Sprockets (simplex, duplex and triplex) and Platewheels to suit B.S. simplex and multi-strand chains.

- **B.S. simplex and multi-strand chains from 6mm to 2" pitch**
- **ANSI simplex from 3/8" to 1 1/2" pitch,**
- **Double simplex sprockets 12 to 25 teeth, for 3/8" to 1" pitch British Standard chain available pilot/ taper bore.**
- **All available with hardened teeth, pilot bore or finished bored with keyway and set-screw**

### Taper Bore Steel Sprockets



Stock range of taper bore steel Sprockets in most tooth sizes from 13 up to 114 teeth, and cast iron in popular tooth sizes from 38 up to 114 teeth; for British Standard simplex, duplex, and triplex chains from 3/8" to 1 1/2" pitch.

**Steel taper bore sprockets are suitable for induction hardening.**

# Cross+Morse Sprockets, Gears, Specials & Rework



Power Transmission Solutions

**Crossbore®**

POWER  
TRANSMISSION

Dedicated production area with specialized CNC machines provides a rapid response rework service of standard. Known as Crossbore®; this service includes re boring, keywaying, setscrewing, blacking, marking and induction hardening.

- **Sprockets, pulleys and gears**
- **Torque Limiters, Crossgard, Safegard and Sheargard Clutches**
- **Jaw, Gear and Chain Couplings**
- **Tolerance of H7, M7 or F7**



## Special Manufacturing

Cross+Morse has an extensive manufacturing capability at our factory in Birmingham and have the ability to produce custom designed sprockets, platewheels, pulleys, spur gears, helical gears, split wheels and ring-gears.

- **Turn, Gearcut, Drill, Tap, Mill, Keyway, Broach, Slot.**
- **Grind, Induction Harden and Blacking.**





Power Transmission Solutions

## Cross+Morse Sprockets, Gears, Specials & Rework

POWER  
TRANSMISSION

### Special Bevel and Mitre Gears



Straight cut bevel and mitre gears with pitch up to 10Mod, and diameter up to 500mm, can be manufactured on short lead times in a variety of materials to suit customer requirements.

- **Standard stock of over 400 different sizes**
- **Manufactured to the Gleason system**
- **Gears can be induction hardened**

### Racks & Gears



Racks are available for standard pitches from 1Mod to 8Mod, in 4 stock lengths of 0.5, 1.0, 2.0 and 3.0 metres. Alternate lengths can be supplied to order.

- **Racks can be machined to suit your application.**
- **Spur gears from 1Mod up to 8Mod pitch, with tooth sizes from 12 to 127 teeth.**
- **Gears can be induction hardened to enhance wear life.**

# RENOLD



- Our leading standard steel transmission chain
- Excellent wear resistance
- Wide waisted GP plate shape
- Fatigue performance rated as ISO + 60%
- Guarantee of 15,000 hours
- End-softened, spin riveted pin for easy cutting
- 3/8" to 4" pitch, simplex & duplex

Renold's unique control over pin / bush contact makes sure that wear life exceeds other brands. Little initial chain adjustment is therefore required. Renold roller chain is highly fatigue resistant, giving up to four times the life of other leading competitor chains.

Breaking loads exceed the minimum requirements of the international standards.

Renold's end-softened pin and spin rivet help to minimise downtime. All you need is a Renold pin extractor

and you can disassemble Renold roller chain in seconds; no need to grind the head of the pin, no need for lengthy downtime.

### Simplex

Renold BS Order Code	ISO No.	Pitch inch	Connecting links					
			4	107	11	26	12	30
SD06B1X10FT	06B-1	0.375	✓	✓	-	✓	-	✓
SD08B1X10FT	08B-1	0.500	✓	✓	-	✓	-	✓
SD10B1X10FT	10B-1	0.625	✓	✓	-	✓	-	✓
SD12B1X10FT	12B-1	0.750	✓	✓	-	✓	-	✓
SD16B1X10FT	16B-1	1.000	✓	✓	-	✓	✓	✓
SD20B1X10FT	20B-1	1.250	✓	✓	-	✓	✓	✓
SD24B1X10FT	24B-1	1.500	✓	✓	✓	-	✓	✓

### Duplex

Renold BS Order Code	ISO No.	Pitch inch	Connecting links					
			4	107	11	26	12	30
SD06B2X10FT	06B-2	0.375	✓	✓	-	✓	-	✓
SD08B2X10FT	08B-2	0.500	✓	✓	-	✓	-	✓
SD10B2X10FT	10B-2	0.625	✓	✓	-	✓	-	✓
SD12B2X10FT	12B-2	0.750	✓	✓	-	✓	-	✓
SD16B2X10FT	16B-2	1.000	✓	✓	-	✓	✓	✓
SD20B2X10FT	20B-2	1.250	✓	✓	-	✓	✓	✓
SD24B2X10FT	24B-2	1.500	✓	✓	✓	-	✓	✓

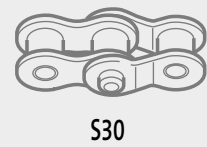
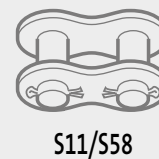

## RENOLD Syno™



- No lubrication normally required
- Outside of chain totally dry-to-the-touch
- Nickel-plated plates
- Food industry-approved lubricant within sintered bush
- Unique food industry-approved roller coating
- Dimensionally interchangeable with standard chain
- ISO standard pin diameter, therefore standard attachments on outer links

For use in hygiene-sensitive applications or situations where contamination from lubricant is to be avoided, Renold Syno chain displays all the characteristics you need from a chain. With a food industry-approved lubricant within the sintered bush, this chain will in almost all instances not need relubricating. The roller coating is also suitable for use in the food industry; a unique feature on any chain.

Available in boxed 10-foot lengths from 06B to 24B and ANSI 40 to ANSI 100, simplex and duplex with a standard pin diameter, this means that Renold Syno chain is dimensionally interchangeable with standard roller chain and is even compatible with standard sprockets.

With the kind of excellent wear and fatigue resistance that you expect from a Renold chain, Syno chain outlasts any competitor

product promoted as low-lube or non-lube. Already tried and tested by major companies in the food sector and elsewhere, if you have to operate with minimal lubrication but can't compromise on performance, we can boost your productivity, cut your downtime and save you time and money.

### Simplex

Renold BS Order Code	ISO No.	Pitch inch	Connecting links				
			26	107	11	12	30
06B1SNX10FT	06B-1	0.375	✓	✓	-	-	✓
08B1SNX10FT	08B-1	0.500	✓	✓	✓	-	✓
10B1SNX10FT	10B-1	0.625	✓	✓	✓	-	✓
12B1SNX10FT	12B-1	0.750	✓	✓	✓	-	✓
16B1SNX10FT	16B-1	1.000	✓	✓	✓	✓	✓
20B1SNX10FT	20B-1	1.250	✓	✓	✓	✓	✓
24B1SNX10FT	24B-1	1.500	-	✓	✓	✓	✓

### Duplex

Renold BS Order Code	ISO No.	Pitch inch	Connecting links				
			26	107	11	12	30
06B2SNX10FT	06B-2	0.375	✓	✓	✓	-	✓
08B2SNX10FT	08B-2	0.500	✓	✓	✓	-	✓
10B2SNX10FT	10B-2	0.625	✓	✓	✓	-	✓
12B2SNX10FT	12B-2	0.750	✓	✓	✓	-	✓
16B2SNX10FT	16B-2	1.000	✓	✓	-	✓	✓
20B2SNX10FT	20B-2	1.250	✓	✓	✓	✓	✓
24B2SNX10FT	24B-2	1.500	-	✓	✓	✓	✓



S11/S58



S26



S107

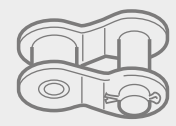

S12



S30

# Renold Hydro-Service®

Superior corrosion resistance for chain



- Superior corrosion resistance
- Last as much as 30 times longer than standard carbon steel
- Hexavalent chrome free
- 350 hours corrosion protection during salt spray tests to DIN 50021
- Cold extruded, solid bush and roller delivering maximum Renold performance
- Plates and rollers shot peened to our exact specifications
- Wear and fatigue resistance that delivers maximum working life
- Lubrication that improves wear performance

Renold Hydro-Service chain delivers superior corrosion resistance, lasting as much as 30 times longer than standard carbon steel in applications that have to deal with water or salt spray. It is ideal for wash-down environments.

Hydro-Service chain is also more economical, and stronger, than stainless steel.

Each component is mechanically treated prior to assembly to ensure consistent, secure protection. The

surface treatment is free of hexavalent chrome, complying with legislation relating to environmental and health & safety considerations.

### Simplex

Renold BS Order Code	ISO No.	Pitch inch	Connecting links				
			26	107	11	12	30
06B1HSX10FT	06B-1	0.375	✓	✓	-	-	✓
08B1HSX10FT	08B-1	0.500	✓	✓	-	-	✓
10B1HSX10FT	10B-1	0.625	✓	✓	-	-	✓
12B1HSX10FT	12B-1	0.750	✓	✓	-	-	✓
16B1HSX10FT	16B-1	1.000	✓	✓	-	✓	-
20B1HSX10FT	20B-1	1.250	✓	✓	-	✓	-
24B1HSX10FT	24B-1	1.500	-	✓	✓	✓	-

### Duplex

Renold BS Order Code	ISO No.	Pitch inch	Connecting links				
			26	107	11	12	30
06B2HSX10FT	06B-2	0.375	✓	✓	-	-	✓
08B2HSX10FT	08B-2	0.500	✓	✓	-	-	✓
10B2HSX10FT	10B-2	0.625	✓	✓	-	-	✓
12B2HSX10FT	12B-2	0.750	✓	✓	-	-	✓
16B2HSX10FT	16B-2	1.000	✓	✓	-	✓	-
20B2HSX10FT	20B-2	1.250	✓	✓	-	✓	-
24B2HSX10FT	24B-2	1.500	-	✓	✓	✓	-



S11/S58



S26



S107

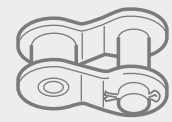

S12



S30

# Renold Conveyor Chain

Standard stock range of BS conveyor chain, available ex-stock. 3,000 to 30,000lb chains produced in our dedicated UK manufacturing cell.



- Fast availability of standard integral attachments
- Standard cast iron sprockets available ex-stock
- Supporting this standard range we also have the capability to supply specials and custom-designed products.

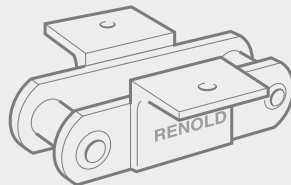
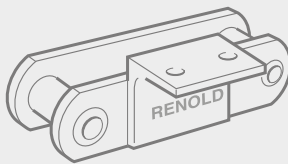
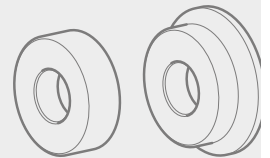
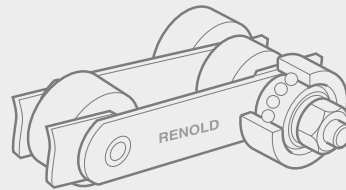
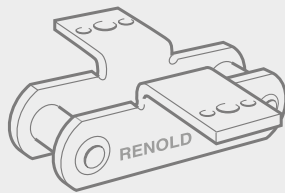
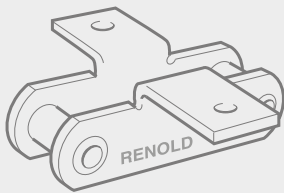

# RENOLD SD



- An extensive product line of European (BS), ANSI and DIN standard chains
- Competitive prices and delivery
- Consistent quality
- Depth of inventory

If you are looking for a good quality product from a reliable supplier for “standard duty” chain applications, look to **RENOLD SD**, the new benchmark in the economy chain category.

Renold is recognized as the worldwide leader in chain products and has established manufacturing facilities across the globe.

While most suppliers buy-in their economy line of chain, Renold manufactures its own.

## Simplex

Renold BS Order Code	ISO No.	Pitch inch	Connecting links					
			4	107	11	26	12	30
SD06B1X10FT	06B-1	0.375	✓	✓	-	✓	-	✓
SD08B1X10FT	08B-1	0.500	✓	✓	-	✓	-	✓
SD10B1X10FT	10B-1	0.625	✓	✓	-	✓	-	✓
SD12B1X10FT	12B-1	0.750	✓	✓	-	✓	-	✓
SD16B1X10FT	16B-1	1.000	✓	✓	-	✓	✓	✓
SD20B1X10FT	20B-1	1.250	✓	✓	-	✓	✓	✓
SD24B1X10FT	24B-1	1.500	✓	✓	✓	-	✓	✓

## Duplex

Renold BS Order Code	ISO No.	Pitch inch	Connecting links					
			4	107	11	26	12	30
SD06B2X10FT	06B-2	0.375	✓	✓	-	✓	-	✓
SD08B2X10FT	08B-2	0.500	✓	✓	-	✓	-	✓
SD10B2X10FT	10B-2	0.625	✓	✓	-	✓	-	✓
SD12B2X10FT	12B-2	0.750	✓	✓	-	✓	-	✓
SD16B2X10FT	16B-2	1.000	✓	✓	-	✓	✓	✓
SD20B2X10FT	20B-2	1.250	✓	✓	-	✓	✓	✓
SD24B2X10FT	24B-2	1.500	✓	✓	✓	-	✓	✓



Nr.4

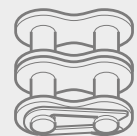

Nr. 26



Nr. 107



Nr. 12

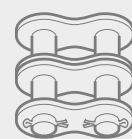

Nr. 11

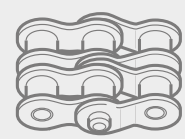

Nr. 30



## Renold Stainless Steel



- All components made from austenitic rust-proof steel
- All components receive surface finishing to remove stress raisers
- Lubrication that improves wear performance
- Tensile strength is approximately 65% that of standard carbon steel chain

Renold Stainless Steel chain is made from high grades of austenitic rust-proof steel. These perform extremely well in environments that are acidic, alkaline, where direct contact with food is a consideration, where the chain will be exposed

to water, and for very high or very low temperature locations ( -40° to +400°C ) where resistance to corrosion is a requirement.

Renold Stainless Steel chain should be selected when resistance to

chemical action is critical.

It is manufactured using FDA approved material and is prelubricated with USDA H1 approved lubricant.

### Simplex

Renold BS Order Code	ISO No.	Pitch inch	Connecting links					
			4	107	11	58	26	12
05B1SSX10FT	05B-1	0.315	✓	✓	-	-	✓	-
06B1SSX10FT	06B-1	0.375	✓	✓	-	-	✓	✓
08B1SSX10FT	08B-1	0.500	✓	✓	✓	-	✓	-
10B1SSX10FT	10B-1	0.625	✓	✓	✓	-	✓	-
12B1SSX10FT	12B-1	0.750	✓	✓	✓	-	✓	-
16B1SSX10FT	16B-1	1.000	✓	✓	✓	-	✓	-

### Duplex

Renold BS Order Code	ISO No.	Pitch inch	Connecting links					
			4	107	11	58	26	12
05B2SSX10FT	05B-2	0.315	✓	✓	-	-	✓	-
06B2SSX10FT	06B-2	0.375	✓	✓	-	-	✓	✓
08B2SSX10FT	08B-2	0.500	✓	✓	✓	-	✓	-
10B2SSX10FT	10B-2	0.625	✓	✓	✓	-	✓	-
12B2SSX10FT	12B-2	0.750	✓	✓	✓	-	✓	-
16B2SSX10FT	16B-2	1.000	✓	✓	✓	-	✓	-

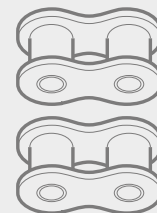

No.4

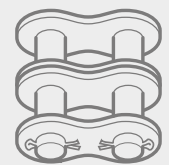

No. 11



No. 107

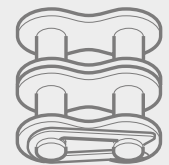

No. 26

**RENOLD**

[www.renold.com](http://www.renold.com)

POWER  
TRANSMISSION



# National Power Local Strength

Supplying industrial products, services and solutions since 1998

## HABIX

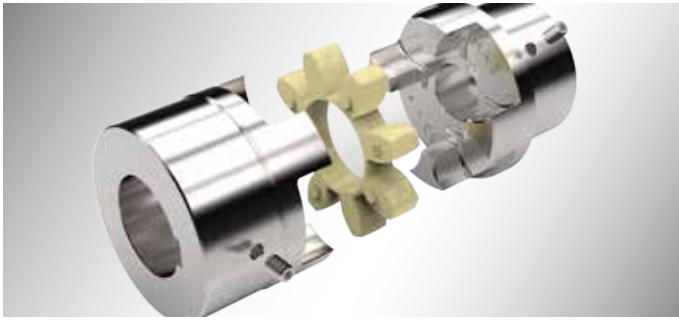

Habix premium quality flexible jaw couplings are machined on all surfaces for precise running characteristics and increased durability.

- Failsafe
- Wear resistant PU Inserts resistant to Oil, Ozone & ageing.
- Temperature Range : -20°C to +80°C
- Balanced to DIN ISO 1940 Q16
- Jaw material Cast Iron EN-GJL-250 (GG-25)

Size	Part 1		Part 2		Part 3		Part 4		All Parts	
	PB (mm)	Max. (mm)	PB (mm)	Max. (mm)	TL Bush	$l_3$ (mm)	TL Bush	$l_4$ (mm)	$d_a$ (mm)	S (mm)
19	0	19	17	24	-	-	-	-	40	16
24	0	24	22	28	1008	22	1008	22	55	18
28	0	28	26	38	1108	22	1108	22	65	20
38	10	38	36	45	1108	22	1108	22	80	24
42	12	42	40	55	1610	25	1610	25	95	26
48	13	48	46	60	1615	38	1615	38	105	28
55	18	55	53	70	2012	32	2012	32	120	30
65	20	65	63	75	2012	32	2517	45	135	35
75	28	75	73	90	2517	45	3020	51	160	40
90	38	90	88	100	3020	51	3535	89	200	45

Size	Max. Speed RPM	Torque (Nm)				Max. Shaft Misalignment		
		White 92A Shore		Red 98A Shore		Radial (mm)	Axial (mm)	Angular (deg)
		Nominal	Changing	Nominal	Changing			
19	19000	10	2.6	17	4.4	0.2	1.2	1.2
24	14000	35	9	60	16	0.22	1.4	0.9
28	11800	95	25	160	42	0.25	1.5	0.9
38	9500	190	49	325	85	0.28	1.8	1.0
42	8000	265	69	450	117	0.32	2.0	1.0
48	7100	310	81	525	137	0.36	2.1	1.1
55	6300	410	105	685	178	0.38	2.2	1.1
65	5600	625	163	940	245	0.42	2.6	1.2
75	4750	1280	333	1920	499	0.48	3.0	1.2
90	3750	2400	624	3600	936	0.5	3.4	1.2

### Type HWN

Pilot Bore

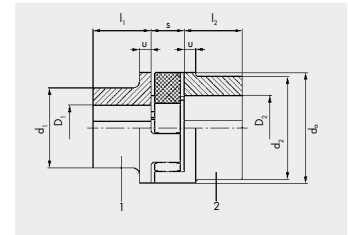

### Type HWT

Taper Bore

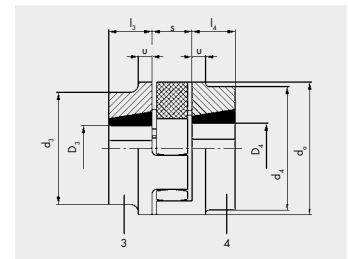

Parts 1, 2, 3 & 4 can be combined

Spider elements available in:

- 92A Shore White
- 98A Shore Red

Performance values are based on an ambient temperature of 30°C, 1500rpm and single plane misalignments. For higher speed, temperature and combined misalignments values should be reduced.

## HABIX Plus – Backflash-free/Low inertia



**Type HPN**  
Finished Bore



**Type HPK**  
Clamping Type

- Precision press-fit of element ensures backlash-free operation.
- Aluminium construction (sizes 19-48) results in very low weight / inertia. (>48 = steel)
- Elements available in Green 65A & Orange 98A Shore
- Temperature Range -30°C to +100°C / 120°C

## PEX



PEX Plug-in type jaw couplings are suitable for a wide range of applications where radial, axial and angular misalignments may be present.

- Failsafe
- Temperature Range: -20°C to +80°C
- Balanced to DIN ISO 1940 Q16

Available in two piece (B) and three piece (A) arrangements. The Type A three piece arrangement enables replacement of flexible elements without the need to move the coupled parts.

### Type A

### Type B

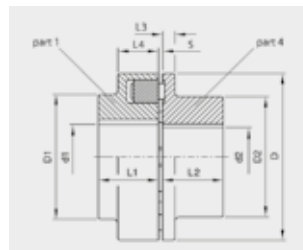
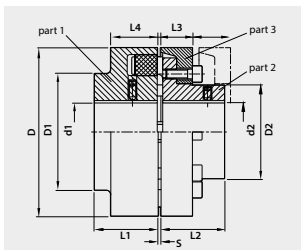

Wear indicator sticker shows when elements need to be changed. Included with all PEX couplings.



- Part 1 is common to both types and includes flexible elements
- Part 2 & 3 are supplied together

## TECHNICAL DATA

Size	Nominal Torque Nm	Max. Speed RPM	Maximum Bore (mm)			D (mm)	L1 = L2 (mm)	S (mm)	Max. Misalignment		
			Part 1	Part 2+3	Part 4				Axial (mm)	Radial (mm)	Angular (deg)
58	19	7500	19	-	24	58	20	3	0.20	0.20	0.15
68	34	7000	24	-	28	68	20	3	0.20	0.20	0.15
80	60	6000	30	-	38	80	30	3	0.20	0.20	0.12
95	100	5500	42	-	42	95	35	3	0.20	0.20	0.12
110	160	5300	48	38	48	110	40	3	0.20	0.20	0.10
125	240	5100	55	45	55	125	50	3	0.25	0.25	0.10
140	360	4900	60	50	60	140	55	3	0.25	0.25	0.10
160	560	4250	65	58	65	160	60	4	0.30	0.30	0.10
180	880	3800	75	65	75	180	70	4	0.30	0.30	0.10
200	1340	3400	85	75	85	200	80	4	0.30	0.30	0.09
225	2000	3000	90	85	90	225	90	4	0.35	0.35	0.09
250	2800	2750	100	95	100	250	100	6	0.35	0.35	0.08

## ORPEX

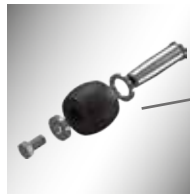

Orpex Pin & Buffer type couplings are ideal for heavy duty flexible coupling applications.

- High reliability / failsafe operation
- Temperature Range : -30°C to +80°C
- Balanced to minimum DIN ISO 1940 Q16. Finer balancing is possible and recommended for circumferential speeds >30m/s
- Available in Type WN cast iron as standard or Type WS steel optional for very high speed applications.
- Larger sizes up to size 2000 with bore up to 640mm and torque transmission capability up to 1,300,000 Nm are available on request.
- Replacement bolts & buffers available

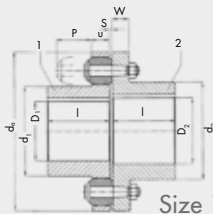

Size 105-360

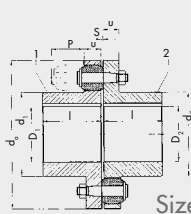

Size 400

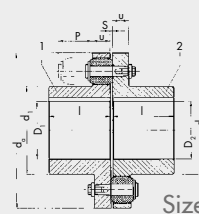

Size 450-500

### TECHNICAL DATA

Size	D <sub>1</sub> Max. (mm)	D <sub>2</sub> Max. (mm)	d <sub>0</sub> (mm)	l (mm)	S (mm)	No. Bolts & Buffers	∅ Bolt & Buffer	Nominal Torque Nm	Speed RPM
105	32	38	105	5	2...4	8	M6	200	5000
125	40	48	125	50	2...4	8	M8	350	5000
144	45	55	144	55	2...4	10	M8	500	4900
162	50	60	162	60	2...5	9	M10	750	4300
178	60	70	178	70	2...5	10	M10	950	3800
198	70	80	198	80	2...5	12	M110	1300	3400
228	80	90	228	90	2...5	11	M12	2200	3000
252	90	100	252	100	2...5	12	M12	2750	2700
285	100	110	285	110	3...6	11	M16	4300	2400
320	110	120	320	125	3...6	12	M16	5500	2100
360	120	130	360	140	3...6	10	M18	7800	1900
400	140	140	400	160	3...6	14	M18	12500	1700
450	160	160	450	180	4...7	12	M16	18500	1500
500	180	180	500	200	4...7	14	M16	25000	1350

## OPTIBELT COUPLING RANGE

In addition to the couplings detailed on the preceding pages, Optibelt offer a wide range of flexible and rigid couplings for all applications.



### FLEX

- Two Tyre options: Standard & FRAS
  - Taper or Pilot bore options
  - To suit shaft sizes 10mm-190mm
- Common Tyre type flexible coupling for reliable transmission of high levels of misalignment.



### HRC

- Taper or Pilot bore options
  - To suit shaft sizes 10mm-115mm
- Popular, general-purpose flexible jaw coupling.



### MINI

- One piece or two piece clamping hubs
  - To suit shaft sizes 3mm-40mm
  - Aluminium or steel / stainless options
- Beam type torsioally rigid / backlash-free flexible coupling. Ideal for servo and positioning drives.



### GEAR

- Shaft  $\varnothing$  up to 1000mm
  - Torque up to 8,000,000Nm
  - Premium or Eco options available
- Torsioally rigid, with greased, crowned gearing to reliably accommodate misalignments on extremely heavy drives.



### FERROFLEX-N

- Torque up to 10,000Nm
  - Temperature up to 280°C
  - Maintenance-free
- Torsioally rigid, backlash-free with spring steel discs allowing flexible compensation of misalignments.



### FLANGE

- Shaft  $\varnothing$  up to 500mm
  - Torque up to 1,425,000Nm
  - Cast iron or steel options
- Robust and reliable rigid shaft connection, able to transmit radial and axial loads.



M Seals specialises in seals for industrial use, from the finest precision seals to the largest heavy duty shaft seals and packings. Our products address the needs of customers that wish to have a broad range of products and solutions at hand.

The company was founded in 1963 and now has offices in 6 countries. M Seals entered the UK market in 2014 and through its 3 distribution centres, supplies high quality sealing products to many industries including oil and gas, aerospace and defence.

At M Seals, we have developed extensive knowledge of seals and their applications, including their composition, lifetime and suitability for a specific job. The right choice of seal minimizes the risk of unexpected breakdowns, and our experienced team are able to advise and provide solutions to our customers. Our dedication and desire for exceptional customer service is paramount.

M Seals UK Ltd is certified to ISO 9001:2015 and ISO 9120:2018, so you can be assured of our quality standards in all areas.

## LEICESTER

Central Distribution Hub

M Seals UK Ltd  
Quartz Close  
Enderby  
Leicester  
LE19 4SG.

## NEWCASTLE

Inspection Centre with AS/EN9120:2018 Accreditation

M Seal NCL Ltd  
Unit E, Aquarius, Kingsway North  
Team Valley Trading Estate  
Gateshead, Tyne and Wear  
NE11 0JH.

## PRODUCTS OVERVIEW

### O-RINGS



M Seals' products are quality assured and we keep over £1.5m of stock ready for next-day delivery. We respond to customers quickly and provide reliable delivery of quality o-rings and sealing products. We stock o-rings in a wide range of materials, including Nitrile, Viton®, EPDM, Neoprene®, Kalrez®, Silicone & PTFE.

Ranges of o-rings include British Imperial (BSI 806), British Metric (BS4518), European Metric (ISO/DIN 3601), including German (DIN 3771), Swedish (SMS 1586/1588) and French (NFT 47 501). American (SAE AS568A, MS 29 513) and Japanese Metric (JISB 2401).

Many of our o-rings are available with various approvals including Norsok M710, FDA, WRC, WRAS, UL, DVGW, KTW, BGVV, KIWA, USP, NSF/ANSI, EN549, EN681-1 and EN682. All approvals can be provided with full certification at request.

### OIL SEALS & V-RINGS



Oil seals or rotary shaft seals are made from synthetic elastomers bonded to case, which is usually metal. They are used in a wide range of applications under very varied conditions.

Oil seals provide an economical means of sealing against rotating shafts. They prevent system lubricants from leaking and also external contamination from entering.

V-rings are unique all-rubber seals for rotary shafts. They are made entirely of rubber material and comprise a body and a conical shaped sealing lip, which is joined to the body by means of a resilient hinge.

V-ring seals are available in a large variety of designs and sizes to fit the requirements of most applications. V-rings are normally made of nitrile rubber. For applications where higher temperatures occur or where aggressive media are present, V-rings made of fluorocarbon rubber should be used.

### CIRCLIPS | FASTENERS



Circlips are a cost saving alternative to fastening. Used in such applications as machined collars on shafts, or washer and pin assemblies, circlips still offer the same benefits of a single fastening mechanism by reducing material waste and the number of components.

M Seals UK can supply the full range of circlips in imperial and metric sizes, please refer to our website [www.m-seals.co.uk](http://www.m-seals.co.uk) for ranges and size charts.



## PRODUCTS OVERVIEW

### CUSTOM MOULDED PARTS



Our success in working with rubber seals leads to our second main field; the supply of moulded parts to our customers design, in all types of rubber, to all kinds of industries.

These items are produced by our partners around the world. They are selected with the aim of supplying the best quality at the right time, at the right price. Fine tolerances, special compounds, conformity to foodstuff norms and ASTM specifications are part of the capabilities of M Seals moulded parts.

PTFE custom parts are another of our special fields, where we have considerable knowledge in-house and work in close cooperation with our highly specialised manufacturers.

### SANITARY GASKETS FOR PIPE COUPLINGS



Specifically for use in pipe systems in the food, pharmaceutical and chemical process industries, we stock a range of gaskets for most types of couplings like DS, DIN 11851, SMS 1149, ISO2853 as well as clamp-types like ISO2852, BS4825/3, ISO 1127, DIN32676 and others.

Most of them can be supplied in NBR, EPDM, FPM, PTFE and silicone, all meeting the requirements of FDA for use with foodstuff. All standard materials are furthermore tested and certified against USP Class VI. All sanitary gaskets that are intended for use in contact with foodstuffs are supplied in accordance with EU 1935:2004.

### BACK-UP RINGS



Back-up rings are installed to prevent the extrusion of an elastomeric O-ring in its housing groove under certain operating conditions.

Solid/Solid Split and Spiral Back-up Rings are usually manufactured in virgin PTFE. Other filled PTFE and plastics are also available depending on the application. They are also available in NBR and Viton 90 in the Contoured Rubber/Par Back range.

## ADDITIONAL PRODUCTS

### BONDED SEALS



Bonded seals available from stock in mild and stainless steel with NBR or FKM rubber. Ranges available include BSP, JIC, German Metric, French Metric and Cetop.

### QUAD RINGS



Quad rings / X-rings can be used in a wide variety of static and dynamic sealing applications. With 2 sealing areas per side for more effective sealing, quad rings have the same dimensions as the BS 1806 O-ring sizes.

Quad rings are available in NBR 70 & 90 shore and FKM 90 shore.

### O-RING CORD



Extruded O-ring cord is available by the metre in many materials and in a range of diameters from 1mm to 30mm.

Materials from stock available include NBR, FKM, red and white silicone, EPDM and PTFE. Special shore hardnesses and colours available upon request.

### WASHERS & GASKETS



Washers and gaskets available in various materials to either drawing or standard sizing.



## OUR SERVICES

M Seals UK puts a range of services in place to ensure customers are happy with the products and services that we supply. We have a dedicated service and aftersales team who provide a fast response, using their technical knowledge and experience to assist you. All products are quality assured and we keep over £1.5m of stock ready for next-day delivery.



### SERVICE & AFTERSALES

Dedicated team with knowledge in each business sector to offer support



### TECHNICAL EXPERIENCE

Over 200 years of experience



### STOCK

Hold volume stocks in the core MRO products and continue to invest in new product lines to ensure availability from sites is there.



### DELIVERY

Next day delivery available up until 17:00 every day

### M SEALS INSPECTION PROCESS



100% inspection guarantee for o-rings' use in critical applications such as Pharmaceutical, Food Processing & Aerospace, all carried out at our on-site testing facility in Gateshead.



## Design | Manufacture | Reassure

DMR Seals Ltd is a UK manufacturer of engineered sealing solutions, offering a wide range of products including high performance O-Rings, Spring Energised Seals, Guide Rings, Rotary Shaft Seals, Wiper Seals, Rod Seals, Piston Seals, Back-up Rings, PTFE Seals and other high-performance seal parts.

At our site in Sheffield we design, manufacture and supply over 253 different seal profiles in Elastomer, Polyurethane, PTFE, Thermoplastic and Fluoropolymer materials as standard, which places us in a strong position to meet any seal application, no matter how demanding.

Whether you need hydraulic seals or PTFE lip seals, rotary lip seals or high-pressure seals, we are confident we will have a seal application solution that is either available off the shelf, or through using our comprehensive seal design service to provide a truly customised sealing solution.

We have over 200 years' collective experience, with many of our senior staff members having worked in the sealing industry for over 25 years. Our industry recognised seals are used across a broad range of industries including Oil & Gas, Chemical Processing, Food, Pharmaceutical, Hydraulics and Pneumatics.

Our seals set the industry standard thanks to strong working relationships with our clients where we spend time building up an understanding of their application needs and the challenges they face. With this information, our expert team of seal designers can provide custom sealing solutions that not only meet the demands placed on them but exceed them too.

DMR seals Ltd is certified to ISO 9001:2015, ISO 14001:2015 and OHSAS 18001:2007, so you can be assured of our quality standards in all areas.

**DMR Seals Ltd**  
 Units 22-26  
 Julian Road  
 Roman Ridge Industrial Estate  
 Sheffield  
 S9 1FZ

DIPLOMA PLC



## PRODUCTS OVERVIEW

### SPRING ENERGISED SEALS



Spring energised seals, often referred to as lip seals or SE-Seals, were originally developed to replace elastomeric O-rings for service in high pressure applications, particularly when low friction and wide chemical compatibility are needed.

SE-Seals can be used in all types of sealing applications from static to dynamic, both rotary and reciprocating. They are effective from vacuum up to pressures of more than 8,700 psig (600 barg), increasing to beyond 18,850psig (1,300 barg) if anti-extrusion backup rings are also fitted. SE-Seal designs are available for seals to operate at temperatures as low -196°C and as high as 260°C.

### PTFE SEALS



The unique properties of PTFE mean seals can be offered with lower frictional properties and increased chemical and thermal resistance, while working at higher speeds and pressures than ever before.

DMR Seals manufactures a vast selection of standard PTFE Seals such as spring energised seals, O-ring energised composite seals, rotary seals and scraper seals to suit most applications, and can provide bespoke engineered solutions for special situations.

### HIGH PRESSURE SEALS



We regularly provide Original Equipment Manufacturers all around the world with reliable high-pressure solutions for their fluid sealing applications working up to 2000 Bar (29,000 Psi) and sometimes higher.

DMR Seals has a wide range of high-pressure sealing profiles for piston, rod, rotary and static face seal use, where materials can also be modified for use in high or low temperatures and aggressive media and chemicals.



## PRODUCTS OVERVIEW

### GUIDE RINGS



DMR offers an expansive range of guide rings to the design engineer and repairer where the prevention of metal-to-metal contact and low frictional loss in hydraulic fluid power and pneumatic sealing systems is critical.

DMR manufactures high quality precise tolerance guide rings from a variety of high performance materials such as Lubricated Polyester fabric Laminate (often referred to as Phenolic), Polyacetal, Lubricated Nylons, PEEK, Various PTFEs and Polyimide.

SEALS

### SYMMETRICAL SEALS



Symmetrical seals are parts that are balanced in shape and can be interchanged for both piston and rod use which makes them useful for emergency retrofit situations where there is a lack of information about the application and an urgent seal is required.

Other than for chevron packing sets and emergency situations, we would always recommend that you utilise one of our asymmetrical rod or piston seals as these have certain design attributes that provide increased stability, sealing performance and a reduction in friction.

### ROTARY SEALS



In most applications, rotary seals or shaft seals are required to retain bearing lubrication and prevent leakage. Special rotary seal types can help improve efficiency by reducing the chance of premature failure. Improvements can be made through the prevention of dust or dirt ingress from the outside environment, reducing the chance of moisture entering the system or by cutting the frictional load on the rotating shaft or bore to help to reduce operating temperatures.

There are many different types of rotary, shaft and swivel seals available from DMR that seal in applications such as:

- Machine tools
- Rolling mills
- Pumps and motors
- Robotic arms
- Drilling equipment
- Mixers
- Rotary swivels and unions

DIPLOMA PLC



## DESIGN

DMR Seals offers an extensive design and engineering support service to meet your specific sealing applications.

We are sealing solutions experts and have over 200 years' combined applications engineering experience, solving problems for our customers.

We generally ask customers to supply us with the following STAMPS information to allow our technical team and application engineers to choose the most suitable seal profile and material.



SPEED



TEMPERATURE



APPLICATION



MEDIA



PRESSURE



SURFACE

## MANUFACTURE

DMR Seals is at the forefront of fluid seal manufacturing and has an exceptional reputation for delivering quality sealing solutions FAST. We operate our own in-house designed CAD/CAM production software and continuously design and add new fluid seal designs to our portfolio.

Since our establishment in 2003 we have continuously invested in the latest CNC manufacturing technology and sealing materials to ensure we always continue to deliver the best quality and service to our clients.

## REASSURE

### Material Testing / Quality / Certification

Quality is at the forefront of all internal operations and totally embedded within our culture.

We have continuously invested in the latest digital measurement, inspection technology and material testing equipment to ensure our products always stand up to the expectations of both our clients and the applications they will operate within.

Our test equipment can provide assurance that the actual production material your parts will be manufactured from meet the standard required. We offer comprehensive certification and inspection levels to suit your requirements. (2.1 / 2.2 / 3.1)

DMR Seals holds the following certification:

- ISO 9001:2015
- ISO 14001:2015
- OHSAS 18001:2007







**BONDLOC**<sup>®</sup>  
FORMULAS THAT WORK



# LET'S STICK TOGETHER.

Bondloc UK is an ISO 9001:2015 certified British manufacturer with over 25 years' experience in high performance industrial and engineering adhesives and sealants.

With over 2000 adhesive formulations, we offer cost-effective, quality products supported by a technical team and IADA's National Distribution Network.

Save up to 50% compared to other leading brands. Formulas that work.

**CONTACT US TODAY  
TO DISCUSS**

- ✓ Bonding projects
- ✓ Costs savings
- ✓ A free sample

**Contact your local  
IADA Distributor**



Threadlockers | Gasket Solutions | Thread Sealants | Retaining Compounds | Instant Adhesives | Structural Adhesives

**BONDLOC**  
FORMULAS THAT WORK

## PREMIUM ADHESIVES & SEALANTS



### B222 SCREWLOCK

For small fasteners, where vibration loosening prevention and non-leakage through threaded fastening is required.

- Colour: Purple (low strength)
- Viscosity: 900-1,500 cps
- Breakaway Strength: 6Nm
- Cure Speed: < 15mins @ 20°C with activator
- Full Cure Time: 12 hours @ 20°C
- Min / Max Temp: -55°C – +150°C
- Pack Size: 10ml, 25ml, 50ml, 250ml



### B243 OIL TOLERANT NUTLOCK

Oil tolerant and designed for direct application onto "as received parts" where oily film exists or where contamination is a problem.

- Colour: Blue (medium strength)
- Viscosity: 1,300 - 3,000cps
- Breakaway Strength: 25Nm
- Full Cure Time: 24 hours
- Cure speed: < 15mins @ 20°C
- Min / Max Temp: -55°C – +180°C
- Pack Size: 10ml, 25ml, 50ml, 250ml



### B270 STUDLOCK

Locks studs up to M20, sealing against leakage & corrosion.

- Colour: Green (high strength)
- Viscosity: 400 - 600cps
- Breakaway Strength: 33Nm
- Cure speed: 10 mins
- Full Cure Time: 12 hours
- Min / Max Temp: -55°C – +180°C
- Pack Size: 10ml, 25ml, 50ml, 250ml



### B515 FLEXIBLE GASKET

Typically used as a form-in- place gasket for pumps & compressors.

- Colour: Purple (medium strength)
- Viscosity: Paste
- Shear Strength: 6N/mm2
- Fixture Time: <35 mins
- Full Cure Time: 12 hours
- Min / Max Temp: -55°C – +150°C
- Pack Size: 50ml, 65ml, 160ml, 250ml, 300ml



### B518 FLEXIBLE GASKET

Seals close fitting joints between rigid metal faces & flanges.

- Colour: Red (medium strength)
- Viscosity: 200,000 - 800,000cps
- Shear Strength: 5N/mm2
- Fixture Speed: < 2 hours with activator
- Full Cure Time: 12 hrs
- Min / Max Temp: -55°C – +150°C
- Pack Size: 50ml, 65ml, 250ml, 300ml



### B542 HYDRAULIC THREAD SEALANT

Used for hydraulic valves, threaded couplings, adaptors, quick disconnect parts, compression fittings and vibration proofing joints.

- Colour: Brown (medium strength)
- Viscosity: 600 - 800cps
- Breakaway Strength: 15Nm
- Max Thread Size: M26
- Fixture Time: 10-20 mins
- Full Cure Time: 24 hours
- Min / Max Temp: -55°C – +150°C
- Pack Size: 10ml, 25ml, 50ml, 250ml



### B574 INSTANT GASKET

Ideal for gearbox sealing, pump flanges, transmission assemblies, cover plates on tanks, cam shaft sealing and bearing gaps.

- Colour: Orange (medium strength)
- Viscosity: 30,000 - 50,000cps
- Breakaway Strength: 8Nm
- Fixture Time: <30 mins
- Full Cure Time: 24 hours
- Min / Max Temp: -55°C – +150°C
- Pack Size: 50ml, 65ml, 160ml, 250ml



### B577 PIPESEAL

Seals all types of threaded connections. Good chemical/ solvent resistance to ethanol, motor oil, unleaded petrol, acetone and brake fluid.

- Colour: Yellow (medium strength)
- Viscosity: 80,000 - 90,000cps
- Breakaway Strength: 11Nm
- Full Cure Time: 6-12 hours
- Fixture Time: <10 mins with activator
- Min / Max Temp: -55°C – +180°C
- Pack Size: 50ml, 65ml, 250ml



### B603 OIL TOLERANT RETAINER

Designed for direct use on "as received parts" such as those with protective films or where surrounding parts contamination is a problem in maintenance.

- Colour: Green (high strength)
- Viscosity: 100-150cps
- Shear Strength: 26N/mm2
- Full Cure Time: 24 hours
- Fixture Time: <15 mins @ 20°C
- Min / Max Temp: -55°C – +150°C
- Pack Size: 10ml, 25ml, 50ml, 250ml



### B638 HIGH STRENGTH RETAINER

For under load structural components such as cylindrical parts, keys, splines, even structural tubing with close tolerance fit.

- Colour: Green (high strength)
- Viscosity: 2,000-3,000cps
- Shear Strength: 25N/mm2
- Fixture Time: <5 mins with activator
- Full Cure Time: 24 hours
- Min / Max Temp: -55°C – +180°C
- Pack Size: 10ml, 25ml, 50ml, 250ml



### B641 BEARING RETAINER

Secures all types and sizes of bearings, shafts and cylindrical parts which will require disassembly in the future.

- Colour: Yellow (medium strength)
- Viscosity: 400 - 800cps
- Shear Strength: >6N/mm2
- Fixture Time: <5 mins with activator
- Full Cure Time: 12 hours
- Min / Max Temp: -55°C – +150°C
- Pack Size: 10ml, 25ml, 50ml, 250ml



### B648 HIGH TEMPERATURE RETAINER

Secures all types of cylindrical parts as per B641 but with continuous working temperature up to 180°C.

- Colour: Green (high strength)
- Viscosity: 400-600cps
- Shear Strength: 26N/mm2
- Fixture Time: <5 mins with activator
- Full Cure Time: 2-6 hours
- Min / Max Temp: -55°C – +180°C
- Pack Size: 10ml, 25ml, 50ml, 250ml

**BONDLOC**<sup>®</sup>  
FORMULAS THAT WORK

## PREMIUM ADHESIVES & SEALANTS

ADHESIVES & SEALANTS

### B390 2 PART INSTANT ADHESIVE



A 2-component, fast curing, gap filling instant adhesive with excellent bonding characteristics. Suitable for a variety of substrates incl. plastics, rubbers and metals.

- Colour: Clear
- Viscosity: Gel
- Base: Ethyl
- Fixture Time (EPDM): 90 – 150 seconds
- Pack Size: 10g

### B401 INSTANT ADHESIVE



Rapid bonding for a range of materials including metals, plastics, elastomers, wood, paper, leather and fabric.

- General purpose
- Colour: Clear
- Base: Ethyl
- Viscosity: 90 – 120cps
- Shear Strength: 15-25N/mm2
- Fixture Time (EPDM): <5 seconds
- Pack Size: 20g, 50g, 500g

### B406 INSTANT ADHESIVE



Designed for bonding rubbers, plastics and elastomeric materials where a rapid fixture is required.

- Rubber & Plastic Bonder
- Colour: Clear
- Base: Ethyl
- Viscosity: 25 – 35cps
- Shear Strength: 15 – 25N/mm2
- Fixture Time (EPDM): <5 seconds
- Pack Size: 20g, 50g, 500g

### B415 INSTANT ADHESIVE



Designed for metal bonding, high viscosity. Can also be used for general purpose.

- Metal bonder
- Colour: Clear
- Base: Methyl
- Viscosity: 1,200 – 1,800cps
- Shear Strength: 15 – 25N/mm2
- Fixture Time (EPDM): <5 seconds
- Pack Size: 20g, 50g, 500g

### B454 INSTANT ADHESIVE



No Drip. Designed for difficult to bond materials which require uniform stress distribution and strong tension/shear strength. Ideal for vertical or overhead applications.

- Thixotropic CA Gel
- Colour: Clear
- Base: Ethyl
- Viscosity: Gel
- Shear Strength: 15 – 25N/mm2
- Fixture Time (EPDM): <5 seconds
- Pack Size: 20g, 300g

### B480 INSTANT ADHESIVE



Rubber toughened adhesive with increased flexibility and peel strength along with enhanced resistance to shock.

- Rubber Toughened (Black)
- Colour: Black
- Base: Ethyl
- Viscosity: 350 – 450cps
- Shear Strength: 15 – 25N/mm2
- Fixture Time (EPDM): <15 seconds
- Pack Size: 20g, 50g, 500g

### B2001 STEEL EPOXY STICK



A steel-filled epoxy putty for general maintenance and repairs. For filling, rebuilding and bonding metal surfaces.

- Colour: Grey
- Viscosity: Putty
- Tensile Strength: 5N/mm2
- Min / Max Temperature: +121°C
- Full Cure: 24 hrs
- Sandable: 20 mins
- Pack Size: 50g, 114g

### B2002 ALUMINIUM EPOXY STICK



Epoxy putty for general maintenance and repairs. For permanent repairs to aluminium surfaces.

- Colour: Light Silver
- Viscosity: Putty
- Shear Strength (Steel): 4.8N/mm2
- Min / Max Temperature: +121°C
- Full Cure: 24 hrs
- Sandable: 20 mins
- Pack Size: 50g, 114g

### B2003 PLASTIC EPOXY STICK



Fast, permanent repairs to most plastics. Allows patching in areas where welding is not possible. Ideal for emergencies.

- Colour: Light Blue
- Viscosity: Putty
- Shear Strength (Steel): 4.8N/mm2
- Min / Max Temperature: +121°C
- Full Cure: 24 hrs
- Sandable: 20 mins
- Pack Size: 50g, 114g

### B2012 RAPID 5 MINUTE CURE



Epoxy Resin Suitable for bonding a wide variety of surfaces including steel, aluminium, and galvanised iron. Product reacts within a few minutes to give a tough resilient bond.

- Colour: Clear
- Viscosity: Viscous Liquid
- Tensile Strength (Steel): 3.8N/mm2
- Working Time: <3 mins
- Fixture Time: <5 mins
- Pack Size: 25ml, 50ml, 400ml

### B3298 UNIVERSAL BONDER



Toughened 1:1 ratio structural adhesive formulated for bonding thermoplastics, metals and composites. Minimal surface preparation and rapid fixture time makes it ideal for many assembly applications.

- Colour: Black / Off White
- Viscosity: Paste
- Tensile Strength: 24-31N/mm2
- Working Time: <7 mins
- Fixture Time: <22 mins
- Full Cure: 24 hours
- Pack Size: 50ml, 400ml

### B7649 ANAEROBIC ACTIVATOR



Speeds cure of all anaerobic fluids and pastes and extends cure through volume, helps fixture time and reduces ultimate cure time. Use B7649 when materials are inactive (plastic or passivated metals) or where temperature is under 15°C.

- Colour: Yellow / Amber
- Base: Heptane
- Evaporation: <60 seconds
- Pack Size: 200ml



## PREMIUM ADHESIVES & SEALANTS

### B5299 SILICON SEALANT



Forms a tough, flexible gasket/ seal that resists ageing, weathering and thermal cycling without hardening. Ideal for oil pans, transmission pans, differential covers, timing gears and valve covers.

- High Temperature
- Colour: Black / Red
- Base: Acetoxy
- Viscosity: Paste
- Min / Max Temp: -55°C – +350°C (Intermittent)
- Skinning Time: 5 mins 20°C
- Pack Size: 80ml, 200ml PowerCan, 310ml

### B7063 SOLVENT CLEANER



Is a unique solvent-based formulation (non-CFC) for cleaning and degreasing of parts and surfaces prior to bonding/sealing and reassembly. This versatile cleaner removes dust, oils, lubrication fluids, metal contaminants and leaves no residue.

- 360° rotational can with easy straw
- Fast evaporating
- No Residue
- Pack Size: 500ml



### ANAEROBICS - SAFER PRODUCT RANGE

Bondloc's Safer Product range of Anaerobic Adhesives are fully compliant with health and safety regulations and without hazard symbols, safety phrases and are COSHH free.

### WL42 NUTLOCK



Our COSHH free version of B242. A Nutlock threadlocker for locking and sealing threaded fasteners. Used on gear box bolts, driveshafts, bearing cover cap screws etc.

- Colour: Blue
- Viscosity: 1,200 – 1,800cps
- Breakaway Strength: 20Nm
- Prevail Torque: 3Nm
- Min / Max Temp: -55°C – +150°C
- Fixture Time: <20 mins
- Pack Sizes: 50ml, 250ml

### WL74 INSTANT GASKET



Our COSHH free version of B542. Instant in-place gasket former making almost any size and shape, ideal for gearbox sealing, pump flanges, transmission assemblies, cover plates on tanks, cam shaft sealing and bearing gaps.

- Colour: Orange
- Viscosity: 30,000cps (Thix.)
- Breakaway Strength: 6N/mm2
- Min / Max Temp: -5°C – +150°C
- Gap Fill: 0.2mm
- Fixture Time: <30 mins
- Pack Sizes: 50ml, 250ml

### WL70 STUDLOCK



Our COSHH free version of B270. This Studlock threadlocker locks studs and seals against leakage and corrosion.

- Colour: Green
- Viscosity: 350 – 550cps
- Breakaway Strength: 20Nm
- Prevail Torque: 18Nm
- Min / Max Temp: -55°C – +150°C
- Fixture Time: <15 mins
- Pack Sizes: 50ml, 250ml

### WL77 PIPESEAL



Our COSHH free version of B577 Pipe Seal. Seals all types of threaded connections. Good chemical/solvent resistance to ethanol, motor oil, unleaded petrol, acetone and brake fluid.

- Colour: Off White
- Viscosity: 5,000 – 20,000cps (Thix.)
- Breakaway Strength: 22Nm
- Min / Max Temp: -55°C – +150°C
- Fixture Time: <30 mins
- Gas approved EN751 & WRAS
- Pack Sizes: 50ml, 250ml



### ENGKIT ENGINEER'S KIT



Packed with 15 different products which have been carefully selected for even the most demanding engineer. Comes in a tough, reinforced plastic case with foam interior.

- B222 Screwlock 50ml
- B242 Nutlock 50ml
- B270 Studlock 50ml
- B401 Cyanoacrylate 20g
- B406 Cyanoacrylate 20g
- B454 Cyanoacrylate Gel 20g
- B574 Instant Gasket 50ml
- B577 Pipe Seal 50ml
- B603 Retainer 50ml
- B641 Bearing Fit 50ml
- B660 Metal Fill Retainer 50ml
- B2001 Steel Epoxy Stick 114g
- B2003 Plastic Epoxy Stick 114g
- B2012 Epoxy Resin 28ml
- B5299 High Temp Silicone 220ml

### HAND SANITISERS



A range of premium hand sanitiser products and automatic dispensing units, formulated with a minimum of 70% alcohol content.

Key Features:

- Antibacterial
- Fast Drying
- Non Tacky
- Multiple EN approvals
- Gel and liquid formulations
- Various pack sizes available



## LET'S STICK TOGETHER.

If you purchase industrial adhesives and work in the engineering, automotive or manufacturing industry, contact your local IADA distributor and put our products to the test.

Threadlockers | Gasket Solutions | Thread Sealants | Retaining Compounds | Instant Adhesives | Structural Adhesives



ADHESIVES & SEALANTS

Performance you can trust

# BEARING GREASES

## Choosing the right product

Selecting the most suitable ROCOL® bearing grease for the job starts here.



LUB & MAIN

### What condition is your bearing operating in?

- ▶ Food/clean environment
- ▶ Normal i.e. no extremes of temperature or condition
- ▶ Fast speeds i.e. greater than 3,000rpm
- ▶ Wet or humid conditions
- ▶ High load or vibration
- ▶ High or low temperature

### What type of bearing requires lubricating?

- ▶ Plain e.g. phosphor bronze bushes
- ▶ Ball, roller, or needle

\* Select whichever temperature range maximum temperature of operation falls within. Except in low temperature applications where the minimum temperature of operation is the main criteria.

### What temperature range is your bearing operating in?\*

	Low	Medium	High
Food	Down to -50°C	-30°C to +160°C	Up to +280°C
Industrial	Down to -73°C	-30°C to +160°C	Up to +280°C

Operating condition	Bearing type	Temperature range	ROCOL product
Normal conditions	All	Low: -50°C to +200°C	SAPPHIRE® Premier
		Medium: -30°C to +160°C	SAPPHIRE® 2, 1 or 000
		High: -50°C to +200°C	SAPPHIRE® Premier
		High: -50°C to +280°C	SAPPHIRE® Endure
High speed	Electric motor / fan bearings	Medium: -30°C to +160°C	SAPPHIRE® Advance 2
	Low or high temperature	Medium: -50°C to +200°C	SAPPHIRE® Premier
Wet conditions	All	Medium: -20°C to +150°C	SAPPHIRE® Aqua 2
High loads	<b>Vibration load:</b> Plain, ball, roller, needle, etc.	Medium/High: -10°C to +235°C	SAPPHIRE® Extreme
	<b>Shock load:</b> Plain, ball, roller, needle, etc.	Medium: -30°C to +150°C	SAPPHIRE® Hi-Load 2

ROCOL® A division of  Ltd



## SAPPHIRE® 2, 1 & 000

Heavy duty bearing greases designed to lubricate and protect all types of ball, roller and plain bearings.

Last three times as long as standard soap-based lubricants and highly effective on cost.

- ▶ Provides outstanding load carrying capability / EP performance .
- ▶ Highly tenacious lubricants with outstanding film strength that stays intact even in severe operating conditions.
- ▶ Multi-complex soap technology enhances shear stability.

### SAPPHIRE 2

Part Code	Size
12171	400g
12175	18kg
12176	5kg
12178	50kg
12179	185kg



TEMP RANGE  
-30°C to +160°C

### SAPPHIRE 1

Part Code	Size
12601	400g
12609	185kg
12614	18kg

### SAPPHIRE 000

Part Code	Size
12284	18kg

## SAPPHIRE® ADVANCE 2

Multi-purpose EP bearing grease fortified with PTFE for maximum bearing life.

Effective in a range of applications operating at high speeds such as electric motors and fan bearings.

- ▶ Lithium complex soap technology with EP additives for outstanding high load performance superior to standard soap-thickened lubricants.
- ▶ Outstanding performance at high speed for most industrial applications.
- ▶ PTFE reduces friction and stick-slip on start-up through more controlled movement.

Part Code	Size
12441	380g
12446	18kg

TEMP RANGE  
-30°C to +160°C

dmN factor  
450,000



## SAPPHIRE® PREMIER

Multi-purpose EP bearing grease fortified with PTFE for maximum bearing life.

Ideal for a range of applications including low or high temperatures, high speeds, and as an effective electrical contact grease.

- ▶ Fully synthetic base oil leaves minimal residues even at elevated temperatures.
- ▶ PTFE reduces friction and stick-slip on start-up through more controlled movement.
- ▶ Outstanding performance at high-speed for most industry applications (dmN factor 500,000)
- ▶ Prevents wear and corrosion on switchgear and electrical contacts in humid, damp or wet conditions.

Part Code	Size
12471	380g
12474	18kg
12475	4kg
12479	170kg

TEMP RANGE  
-50°C to +200°C

dmN factor  
500,000



## SAPPHIRE® EXTREME

A high load, high-temperature MoS<sub>2</sub> bearing grease.

Combines the resilience of a clay thickener with molybdenum disulphide to ensure an effective lubricating film under the most extreme loadings where grease film is squeezed out.

- ▶ Non-melting, organically-modified clay (Bentone) thickened grease fortified with molybdenum disulphide, water-resistant and effective at high temperatures.
- ▶ Ideal for highly loaded applications where shock and vibration occur.
- ▶ Excellent corrosion resistance to protect in humid, damp or wet conditions.
- ▶ Maintains integrity in extreme conditions and protects over extended intervals to reduce lubricant usage and equipment failure.

Part Code	Size
12211	400g
12214	18kg
12216	5kg
12218	50kg
12219	160kg

TEMP RANGE  
-10°C to +235°C



LUB & MAIN

To order contact your local IADA member today or visit: [www...](http://www...)



Performance you can trust

## SAPPHIRE® AQUA 2

Multi-purpose water-resistant EP bearing grease ideal for applications operating in damp, humid, wet or water-submerged conditions.

- ▶ Adheres strongly to components to resist water wash-off and even tidal flow in salt water environments.
- ▶ Excellent corrosion resistance to protect in humid, damp and even wet conditions.
- ▶ Aluminium complex soap technology with EP additives for outstanding high load performance superior to standard soap-thickened lubricants.

Part Code	Size	TEMP RANGE
12751	380g	-20°C to +150°C
12754	18kg	
12755	4kg	
12758	50kg	



## KEEP IT RUNNING SMOOTHLY WITH SAPPHIRE® FROM ROCOL

Premature failure of even the smallest bearing can result in significant downtime and loss of production. For efficient plant performance and machinery that runs smoothly, always choose a lubricant that's reliable and lasts the distance.



Use your phone camera to scan the QR code to find out more

## SAPPHIRE® HI-LOAD 2

Long life, multi-purpose bearing grease fortified with MoS<sub>2</sub>.

Combines the triple life performance of SAPPHIRE 2 with molybdenum disulphide providing an effective lubricating film under the most extreme loadings where grease film is squeezed out.

- ▶ High tenacity film with extreme durability that reduces frictional heat, wear and extends component life and lubrication intervals.
- ▶ Ideal for highly loaded applications where shock and vibration occur.
- ▶ Maintains integrity in extreme conditions and protects over extended intervals to reduce lubricant usage and equipment failure.

Part Code	Size	TEMP RANGE
12761	400g	-30°C to +150°C
12764	18kg	
12765	5kg	



## SAPPHIRE® Spray Grease

Multi-purpose EP grease fortified with PTFE in an easy-to-apply aerosol.

- ▶ Provides excellent protection for components at low temperatures and in extreme sub-zero conditions.
- ▶ Lithium complex soap technology with EP additives for outstanding high load performance.
- ▶ Fully synthetic base oil leaves minimal residues even at elevated temperatures.
- ▶ Highly resistant to oxidation and protects over extended intervals to reducing lubricant usage, equipment failure and downtime.
- ▶ Excellent corrosion resistance to protect in humid, damp or wet conditions.
- ▶ PTFE reduces friction and stick-slip on start-up through more controlled movement.

Part Code	Size	TEMP RANGE
34305	400ml	-50°C to +200°C



To order contact your local IADA member today or visit: [www...](http://www...)



# CHAIN LUBRICATION

## Choosing the right product

For the greatest results, choose the ROCOL® chain lubricant to suit the operating conditions. Choose from the list below and consult the chart to find your optimum product.

- ▶ Normal i.e. no extremes of temperature or condition
- ▶ High temperature of up to +280°
- ▶ Extra high temperature of up to +550°
- ▶ Dusty conditions

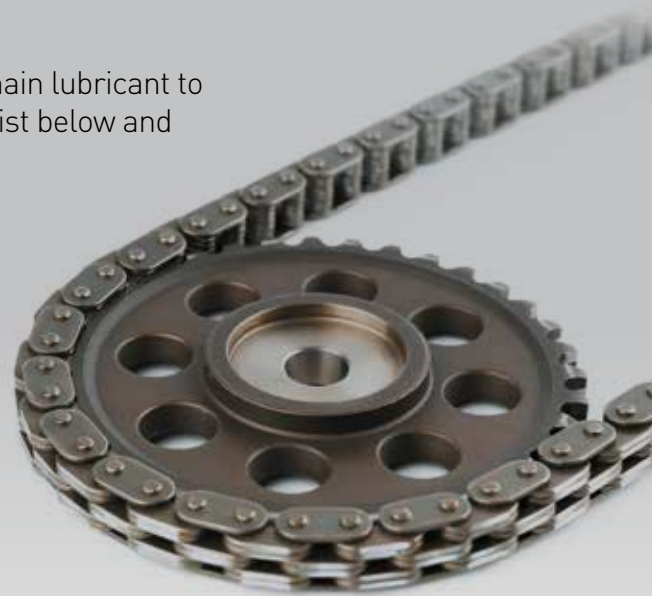

This chart is intended to assist product selection for most common types of applications. If in doubt phone ROCOL Technical Helpline or your ROCOL Sales Engineer.

Primary operating condition	Aerosol or fluid	Temperature range	ROCOL product
Normal conditions	Aerosol	Medium: -30°C to +150°C	CHAIN & DRIVE Spray
		Medium: -30°C to +180°C	CHAINGUARD Hi-Load Spray
	Fluid	Medium: -15°C to +120°C	CHAIN & DRIVE Fluid
	Aerosol / Spray	Low: -55°C to +250°C	SAPPHIRE® Precision Lube Spray
Medium-High temperature	Fluid	Medium: +10°C to +230°C	CHAINGUARD 230
	Fluid	High: 0°C to +280°C	CHAINGUARD 280
Extra high temperature	Fluid	Extra high: -10°C to +550°C	CHAINGUARD 550
Dusty conditions	Fluid/Aerosol	Medium: -50°C to +450°C	DRY MOLY Fluid / Spray

LUB & MAIN

Turn the page for a full selection of Chain Lubrication products from ROCOL®



Performance you can trust

## CHAIN & DRIVE Spray / Fluid

High-performance EP chain and conveyor lubricant with a unique formula ensuring maximum performance for penetration, lubrication and corrosion protection.

- ▶ Provides excellent penetration into chain links and pins
- ▶ Highly tenacious water-resistant film to dewater and protect all types of chains in wet or humid environments
- ▶ Offers excellent corrosion protection on chains in hostile environments
- ▶ Great adhesion reducing drips and fling-off

### Spray

Part Code	Size
22001	300ml

TEMP RANGE
-30°C to +150°C

### Fluid

Part Code	Size
22306	5L
22309	20L

TEMP RANGE
-15°C to +120°C



## CHAINGUARD HI-LOAD Spray

High-performance chain and conveyor lubricant with MoS2. Designed to ensure maximum performance for penetration, lubrication and corrosion protection.

- ▶ Provides excellent penetration into chain links and pins
- ▶ Highly tenacious water-resistant film to dewater and protect chains in wet or humid environments; and can be applied to chains already damp
- ▶ Offers excellent corrosion protection on chains in hostile environments
- ▶ Great adhesion reducing drips and fling-off

Part Code	Size
22141	300ml

TEMP RANGE
-30°C to +180°C



## CHAINGUARD 280

High-temperature chain and conveyor lubricant for all drive and transport chains working in conditions up to 280°C. Specifically formulated with synthetic esters and antioxidants for optimum performance through thermal stability, low evaporation loss and minimal deposit formation.

- ▶ Excellent anti-wear properties at high temperatures for longer chain life and reduced wear
- ▶ Excellent frictional properties reducing power consumption on chain drive units
- ▶ Special antioxidant combination provides longer wet film life with low deposit and varnish formation
- ▶ Keeps oil-ways clear for more efficient lubrication
- ▶ Penetrates links and pins lubricating in the highest potential wear areas
- ▶ Low fuming provides a clean and safe working environment

## CHAINGUARD 230

High-temperature chain and conveyor lubricant for all drive and transport chains and bearings working in conditions up to 230°C. Specifically formulated with synthetic esters and antioxidants to ensure high performance.

- ▶ Excellent anti-wear properties at high temperatures for longer chain life and reduced wear
- ▶ Excellent frictional properties reducing power consumption on chain drive units
- ▶ High thermal stability and low evaporation loss
- ▶ Minimal deposit formation with no hard carbon
- ▶ Low fuming provides a clean and safe working environment

Part Code	Size
22255	5L
22265	20L

TEMP RANGE
+10°C to +230°C



Part Code	Size
22235	5L
22236	20L

TEMP RANGE
0°C to +280°C



To order contact your local IADA member today or visit: [www...](http://www...)





## CHAINGUARD 550

High temperature, graphite-based dry film chain lubricant specifically formulated for use in ovens where conditions reach up to 550°C.

- ▶ Excellent EP and anti-wear properties at high temperatures for longer chain life and reduced wear
- ▶ Low fuming provides a clean and safe working environment
- ▶ Attracts no dust or dirt when operating as a dry film above 180°C
- ▶ Dry film coating reduces potential contamination common with wet chain lubricants
- ▶ Evaporates cleanly as oven reaches full operating temperature leaving no carbonised residue

Part Code	Size	TEMP RANGE
22076	5L	-10°C to +550°C
22075	20L	



## DRY MOLY FLUID/SPRAY

Resin-bonded molybdenum disulphide film designed to lubricate sliding mechanisms such as plain bearings, pins, cams and slides where a wet lubricant cannot be tolerated.

- ▶ Dry film lubrication protects against contaminants
- ▶ Prevents galling, pick up and seizure
- ▶ Resistant to high loads (up to 7,000 kg/cm<sup>2</sup>)
- ▶ Excellent wear resistance (high molybdenum disulphide content)

Spray		TEMP RANGE
Part Code	Size	
10025	400ml	+10°C to +230°C

Fluid	
Part Code	Size
10205	5L



LUB & MAIN

## BAKERLUBE™

Our range of NSF H2 registered, ester based, high temperature, bakery oven chain lubricants with extreme pressure additives.

### BAKERLUBE™ HT

Extreme high-temperature graphited chain lubricant for bakery oven chains.

- ▶ High load carrying performance extends chain life
- ▶ Clean evaporating base oil leaves no carbonised residue
- ▶ For temperatures where conventional fluids fail
- ▶ Solvent-free formulation ensures a clean and safe working environment
- ▶ NSF H2 Registered

Part Code	Size	TEMP RANGE WET FILM
15705	20L	-10°C to +180°C
		TEMP RANGE DRY FILM
		up to +550°C

45 H2



### BAKERLUBE™ CL

High temperature long-life extreme pressure chain and conveyor lubricant.

- ▶ Outstanding resistance to oxidation
- ▶ Solvent-free formulation ensures a clean and safe working environment
- ▶ Excellent penetration extends chain life
- ▶ Clean, residue-free film
- ▶ Suitable for automatic lubricators
- ▶ NSF H2 Registered

Part Code	Size	TEMP RANGE
15605	20L	-0°C to +280°C

44 H2



**Need a survey? Contact your local IADA member to arrange a full on site lubrication survey today.**

Performance you can trust

# HYDRAULIC & GEARBOX OILS

## SAPPHIRE® HI-TORQUE

High performance, semi-synthetic gearbox fluids.

- ▶ Reduces wear to significantly extend gear box life
- ▶ Contains unique SUPS technology to protect gear teeth on start-up
- ▶ Offers high performance even under extreme pressure
- ▶ Decreases oil change frequency reducing total cost of ownership

### Hi-Torque 150

Part Code	Size
21055	20L
21059	200L

### Hi-Torque 320

Part Code	Size
21025	20L
21029	200L

### TEMP RANGE

-20°C to +120°C

### Hi-Torque 220

Part Code	Size
21015	20L
21019	200L

### Hi-Torque 460

Part Code	Size
21035	20L

### Hi-Torque 680

Part Code	Size
21045	20L

## SAPPHIRE® HI-POWER

Hydraulic, airline and compressor oils.

- ▶ Reduces material wear to significantly extend component life
- ▶ High thermal stability increases oil change intervals and prevents sludge formation
- ▶ A low carry-over system eases air and oil separation to ensure clean air and maximum power transfer
- ▶ Available in a range of viscosities for all pneumatic and hydraulic applications

### Hi-Power 32

Part Code	Size
52545	20L
52549	200L

### Hi-Power 46

Part Code	Size
52555	20L
52559	200L

### TEMP RANGE

-20°C to +120°C

### Hi-Power 68

Part Code	Size
52565	20L
52569	200L

### Hi-Power 100

Part Code	Size
52575	20L
52579	200L





## FOODLUBE® HI-TORQUE

High performance fully synthetic gear oils incorporating start-up protection system (SUPS) and anti-wear additives to provide maximum lubrication and protection in all types of gearboxes.

- ▶ Contains SUPS: unique protection for gear teeth on start-up and during use
- ▶ Outstanding load-carrying performance: FZG load stage 12
- ▶ Excellent anti-wear performance without the need for extra additive treatments

### Hi-Torque 150

28 H1

Part Code	Size
15426	5L
15425	20L
15429	200L

### Hi-Torque 320

13 H1

Part Code	Size
15766	5L
15765	20L
15769	200L

TEMP RANGE

-20°C to +150°C

### Hi-Torque 220

8 H1

Part Code	Size
15526	5L
15525	20L
15529	200L

### Hi-Torque 460

27 H1

Part Code	Size
15775	20L
15779	200L

## FOODLUBE® HI-POWER

High-performance, fully synthetic oils incorporating an optimum blend of additives for optimum protection.

- ▶ Suitable for use in hydraulics, air compressors and airline systems
- ▶ Enhanced oxidation stability
- ▶ Extremely low sludge build-up and minimal foaming
- ▶ Unique L-CO system reduces carryover

### Hi-Power 22

5 H1

Part Code	Size
15796	5L
15795	20L
15799	200L

### Hi-Power 32

6 H1

Part Code	Size
15896	5L
15895	20L
15899	200L

TEMP RANGE

-50°C to +120°C

### Hi-Power 46

18 H1

Part Code	Size
15995	20L
15999	200L

### Hi-Power 68

3 H1

Part Code	Size
16006	5L
16005	20L
16009	200L



LUB & MAIN



**\* Gear Oils with Start Up Protection System (SUPS) Rocol® Start Up Protection System technology allows gears to be protected immediately following start-up which reduces wear and prevents failure.**

Use your phone camera to scan the QR code to see our demonstration video



Performance you can trust

# CUTTING FLUIDS

## V-CUT™

Market leaders in cutting performance and dilution, our trusted range of cutting fluids protect tools for longer, ensuring performance and quality at a highly competitive price.

### V-CUT™ MP

- ▶ Milky type water mix fluid for all general cutting operations
- ▶ Effective on various metals with excellent results on low to medium carbon steels
- ▶ Highly economical dilutions up to 35:1

### V-CUT™ SS

- ▶ Semi-synthetic water mix fluid for all general cutting and grinding operations
- ▶ Allows rationalization to one product for cutting and grinding
- ▶ Effective on most metals especially low to medium carbon steels
- ▶ Extremely economical dilutions up to 65:1
- ▶ Translucent green emulsion allows a clear view of the workpiece

### V-CUT™ EP

- ▶ Extreme pressure water mix fluid for heavy-duty cutting operations
- ▶ Contains extreme pressure additives enabling top performance on hardened steels or similar tough alloys
- ▶ Extended tool life and faster machining rates provide cost savings on expensive tooling



#### V-CUT MP

Part Code	Size
51543	20 l

#### V-CUT SS

Part Code	Size
51523	20 l

#### V-CUT EP

Part Code	Size
51533	20 l
51530	55 l



## RTD®

Our range of hand-applied cutting lubricants includes a unique formulation to provide superior performance across a range of ferrous and non-ferrous metals.

### Suitable for use on many metals including hardened/difficult to machine materials

#### RTD® LIQUID

- ▶ Flows to the cutting edge
- ▶ Oil and solvent free
- ▶ Available in a plastic squeeze bottle for easy application

Part Code	Size
53072	400 g
53076	5 l
53078	20 l



#### RTD® COMPOUND

- ▶ Soft low melting-point paste
- ▶ Formulated to cling to the tool staying in place for longer
- ▶ Rolls Royce approved - Spec CSS 137 Type B and C
- ▶ NATO Stock Number: 9150 99 220-2775
- ▶ NATO Stock Number: 9150 99 464-6766

Part Code	Size
53020	50 g
53023	500 g
53026	5 kg
53028	18 kg



### The Reichert Wear Test is used to evaluate the extreme pressure (EP) properties of lubrication and cutting fluids.

The test shows how much protection is provided to the cutting tool and component during operation. The lower the result (measured in % wear), the more protection is provided. This industry-standard test demonstrates how RTD outperforms the competition, letting you cut with confidence.

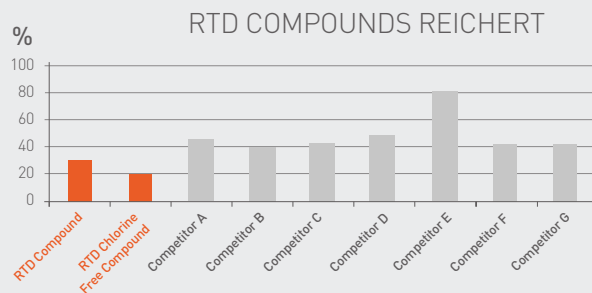
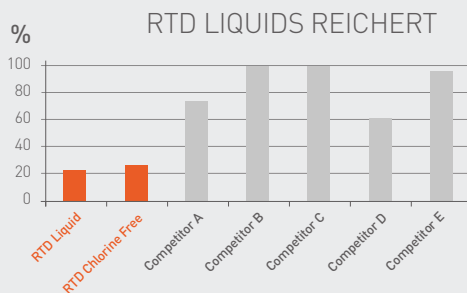

#### RTD® FOAMCUT

- ▶ Clean, low odour foaming spray
- ▶ Rapidly penetrates to the cutting edge
- ▶ Foaming action adheres to the tool and stays in place for longer

Part Code	Size
53041	300 ml



#### RTD® SPRAY

- ▶ Use on rotating applications - easy and safe
- ▶ NATO Stock Number: 9150 99 541-7134
- ▶ Quick and convenient to use

Part Code	Size
53011	400 ml



#### RTD® CLEAN CUT

- ▶ Extends tool life and improves surface finish
- ▶ Suitable for aluminium and yellow metals
- ▶ Compatible with water mix cutting fluids

Part Code	Size
53062	350g
53066	5l



#### RTD® CHLORINE FREE LIQUID/SPRAY/COMPOUND

- ▶ Superb cutting performance
- ▶ Suitable for all ferrous metals
- ▶ Ideal for reaming, tapping, drilling workshop operations

Part Code	Size	Part Code	Size
53521	350ml	53513	450g
53081	400ml	53526	5l



Performance you can trust

# CLEANING

## QUICK & CLEAN

Hand cleaning wipes highly effective in removing all kinds of oil, grease, grime, paint, diesel, ink and everyday dirt.

- ▶ Alcohol-based formula provides a powerful clean to remove contaminants quickly
- ▶ Large 28 × 28 cm size for effective cleaning first time
- ▶ Quick, easy and convenient to use, saving time and money on cleaning up
- ▶ Hands are cleaned, moisturised and re-vitalised
- ▶ Saves on space by replacing towel dispensers and cloth bins
- ▶ Protects workwear by providing an easy-to-access hand cleaning solution

Part Code	Size
34200	150 wipe pack



## SCRUBS

Premium, heavy-duty cleaning towels with a tough texture and citrus-based formula to loosen, dissolve and absorb dirt and grease from your hands.

- ▶ Works fast to loosen, dissolve & absorb dirt, oil, grease, tar, inks, dyes, paints, epoxies, sealant, urethanes and adhesives
- ▶ Textured on one side for heavy-duty cleaning
- ▶ Will not transfer soil back onto hands
- ▶ Quick and easy one-step cleaning process
- ▶ Removes the heaviest of contaminants whilst a conditioner softens the hands
- ▶ Supplied in tough buckets, durable while light & portable

Part Code	Size
42272	72 wipe pack



**Remove stubborn marks caused by oil, grease, paint, ink, silicone and adhesives from your hands or surfaces in seconds.**



## HEAVY DUTY CLEANER SPRAY

High performance, water-dispersible, heavy-duty cleaning fluid.

- ▶ Penetrates and loosens workplace grime, grease and dirt
- ▶ Emulsifies oil and grease to allow removal by hosing or wiping
- ▶ Safe on metal, paint and most plastics
- ▶ Free from chlorinated solvents
- ▶ Ideal for Industrial machinery, flooring, concrete and paving
- ▶ Easily washed or hosed off with water

Part Code	Size
34011	300ml



## INDUSTRIAL CLEANER RAPID DRY SPRAY

Food grade, quick-drying multi-purpose cleaner.

- ▶ Dries rapidly without leaving a residue
- ▶ Includes specially formulated blend of degreasing solvents
- ▶ Effectively removes grease, oil and workshop grime from all surfaces
- ▶ Safe on metal, most plastics and paints
- ▶ NSF K1 Registered

Part Code	Size
34131	300ml

46 K1



## FOAM CLEANER SPRAY

Powerful, solvent-free, fast-acting foaming cleaner that's food-safe.

- ▶ Water-based - free from solvents
- ▶ Cuts through grease, dirt and grime quickly
- ▶ Active foaming - expands to cover larger areas
- ▶ Ideal for non-porous surfaces
- ▶ Safe for use on most plastics, rubbers and painted surfaces
- ▶ NSF A1 Registered

Part Code	Size
34141	400ml

22 A1



## REMOVER & DEGREASER SPRAY

Heavy-duty, multi-purpose citrus-based label remover.

- ▶ Powerful and fast-acting - removes labels quickly
- ▶ Pleasant characteristic odour
- ▶ Safe on metal, most plastics and painted surfaces
- ▶ NSF C1 Registered

Part Code	Size
34151	300ml

49 C1



## ELECTRA CLEAN SPRAY

A powerful, ultra-fast drying electrical contact, equipment and component cleaner.

- ▶ Effectively degreases and cleans electrical switches and switchgear
- ▶ Rapid evaporation to leave no residue
- ▶ Removes light to medium grease and oil contamination
- ▶ Compatible with most plastics
- ▶ NSF K2 Registered

Part Code	Size
34066	300ml

33 K2



## PRECISION AIR DUSTER

High-pressure cleaner using air blasts to remove dust and debris from delicate items or areas difficult to reach.

- ▶ Suitable for use on most mechanical and electrical equipment
- ▶ 360° valve for use in tough to reach areas
- ▶ Innovative valve technology allows multi-angle use
- ▶ Non-flammable
- ▶ NSF K2 Registered

Part Code	Size
32315	252ml

63 K2





Performance you can trust

# FOOD GRADE LUBRICATION

## FOODLUBE® SPRAY GREASE

High performance, multi-purpose, food-grade grease. Fortified with PTFE, designed for the enhanced lubrication of all types of slides, bushes, pins and bearings.

- ▶ Superior load and wear properties significantly extend bearing life
- ▶ Highly resistant to water washout offering excellent corrosion protection

Part Code	Size	TEMP RANGE
15030	400ml	-50°C to +160°C

31 H1



## DRY PTFE SPRAY

Food grade, premium performance, invisible dry film lubricant. Low friction, non-stick, PTFE lubricant for the dry lubrication of cams, slides, open bearings, chutes and shears.

- ▶ Non-staining film reducing machine friction
- ▶ High percentage PTFE content actively reducing waste
- ▶ For use where a wet film cannot be tolerated

Part Code	Size	TEMP RANGE
34235	400ml	-200°C to +270°C

4 H1



## FOODLUBE® CHAIN SPRAY

Tenacious, food-grade spray lubricant for extended chain life, ideal for all types of drive and conveyor chains.

- ▶ Outstanding penetration into links and pins for maximum protection
- ▶ Highly resistant to water wash off, protecting through clean downs
- ▶ Effective load-carrying capacity to protect critical parts of the chain
- ▶ Tenacious low drip formulation reduces the risk of contamination
- ▶ Good water displacing properties

TEMP RANGE
-20°C to +150°C

Part Code	Size
15610	400ml

16 H1





## FOODLUBE® WD SPRAY

Food grade water displacing and lubricating spray fortified with PTFE.

- ▶ Silicone-free formulation
- ▶ Excellent anti-wear and lubricating properties extending component life
- ▶ Superior penetrating and cleaning performance to clean and lubricate in one application
- ▶ Outstanding corrosion protection

Part Code	Size	TEMP RANGE
15010	300ml	-20°C to +110°C
<b>32</b> <b>H1</b>		



## FOODLUBE® MULTI-LUBE FLUID

A fully synthetic, multi-purpose lubricant, fortified with PTFE for effective lubrication particularly on chains, bearings and slides.

- ▶ Clean, non-toxic, thin film aids fast penetration
- ▶ Good load-carrying properties, protecting components for longer
- ▶ Excellent corrosion protection
- ▶ Available as bulk or convenient trigger pack

Part Code	Size	TEMP RANGE
15120	500ml	-50°C to +180°C
15126	5L	
<b>20</b> <b>H1</b>		



## FOODLUBE® DISMANTLING SPRAY

A fast-acting, highly penetrating food-grade spray for the effective release of corroded and seized components.

- ▶ Highly efficient penetration
- ▶ Short term corrosion protection for released parts
- ▶ Non-toxic formula

Part Code	Size	TEMP RANGE
15720	300ml	-20°C to +110°C
<b>23</b> <b>H1</b>		



## PRECISION SILICONE SPRAY

Food grade, high performance, silicone aerosol lubricating film with wide temperature stability for use on slides, chutes, bearings and conveyors.

- ▶ Long-lasting formulation with active ingredient significantly reduces waste
- ▶ Resists oxidation and corrosion
- ▶ Non-toxic, clean and colour-free

Part Code	Size	TEMP RANGE
34035	400ml	-50°C to +200°C
<b>1</b> <b>H1</b>		



LUB & MAINT

**Need help keeping your oil stores tidy?**  
ROCOL® provide a selection of storage cabinets and storage options giving easy access to ROCOL products and maintaining stocks are at the correct levels.



# TYGRIS™

Fulfilling the essential Cleaning, Lubricating and Protecting needs of Industry since 1971, TYGRIS is a trusted and established source of

- **PROTEAN Food Grade Lubricants**
- **Industrial aerosols, bulk oils and greases**
- **General maintenance, repair and operations (MRO) solutions**
- **Industry/application specific products + bespoke product development**
- **High performance VariSpray paints, primers and protective coatings**
- **Spill Control Solutions for Containing Absorbing Handling**
- **Industrial hand wipes**

**and much, much more....**

Our ever expanding range now includes, TYGRIS, PROTEAN, INGENIUS, OneWipe & DEFENCE+. All of which have been developed with the customer at their core, our 4Life Guarantee ensures peace of mind.

At TYGRIS the commitment to our partners and end users comes through from our incredible TEAM101 which has been created from a passion of technical expertise and dedication to offer an experience exceeding customers expectations.



team101@tygrisindustrial.com | tygrisindustrial.com

# Why TYGRIS?

- Expanding range of industry leading products
- Innovation to combat long standing problems
- Free technical onsite surveys
- Samples available on request
- Products and performance Guaranteed 4Life

We pride ourselves on the quality of our products and services, the dedication and expertise of our customer-centric team and our close working relationship with TYGRIS approved distributors and end-users alike.

From our renowned TYGRIS 4Life (lifetime) Guarantee to our TYGRIS Sample Order Service, and from our TYGRIS AWARENESS training programme to TYGRIS CONNECT accompanied end-user visits, there's never been a better time to CHOOSE TYGRIS!

**Make TYGRIS your #1 choice for all your Cleaning, Lubricating and Protecting needs!**



# PROTEAN FOOD SAFE

LUB &  
MAIN

PROTEAN, essential nutrition for industry, is an innovative product range launched by TYGRIS and the successful culmination of years of intense focus and commitment, extensive research & development, significant end-user engagement and a determination to overcome even the most challenging of obstacles.

Our PROTEAN range has been created to serve a variety of industries, so whether you are looking for an Electrical Cleaner to clean or degrease your electrical components or perhaps Greases that will offer enhanced anti-wear performance for prolonged component life, or even Sugar Dissolving Fluid to rapidly dissolve sugars and fondant, we've got it here at TYGRIS!





## PROTEAN AEROSOLS

Part of the Protean philosophy is making users lives easier. That's why a wide selection of our food-grade products are available in a handy aerosol format. With a compact size and easy usage, these sprays are an essential part of the Protean range. From anti-rust agents to sticky label remover, these cans make application simple.



## PROTEAN CLEANERS

In the food and beverage processing industry, or any industry with a cleanroom environment for that matter, cleanliness is paramount. That's why we developed our Protean Cleaners, so you can keep your processing areas clean, without the risk of contamination. Developed to the highest standards for varied industries, you can find products from Sugar Dissolving Fluid to Electrical Cleaner.



## PROTEAN GREASES

At TYGRIS, providing the highest quality greases suitable for use in a wide range of industries is our speciality. Our expertise has led to the development of our game-changing food-approved grease. With High-Temperature Grease, 3H1 or Ultima 2 on offer, you can rest assured that our products are made to the highest standards of quality available on the market.



## PROTEAN OILS

We take quite a bit of pride in delivering superior quality oils that are designed to work with a range of uses. Our products range from the Protean Airline Oil, designed for pneumatic airline systems to the Protean Chain & Gear 100, designed to lubricate drive and chain belts. No matter the job, we have innovative products to help get it done.

LUB & MAIN





LUB & MAIN

# COLOUR CODED FOR EASY RECOGNITION

Choosing the right product for the right environment is essential and our colour coding system makes it easy to distinguish between products.

Make life easier for your team or your customers by picking out the right colour everytime!

We developed a colour coding system for easy recognition of all Food Grade products. This improves efficiency and reduces risk of contamination. Make storage and re-ordering easy for your team with our detailed wall charts customised to your needs. Revolutionise the way you work and create a safer environment, speak to one of our technical specialists and find out how PROTEAN Colour Coded would work for you.







# PROTEAN ASSURED

A Complete  
'Food Safe' Solution

- Free on site survey
- Lubrication Needs Assessments
- Bespoke Storage Solutions
- Real-time Support
- Audit Compliance
- Assurance Guaranteed

## EASY ONLINE ACCESS TO CRITICAL INFORMATION

All of our key information such as product data sheets and certifications are all available on our website without the need to register or login you have unrestricted access to everything you need.



## BESPOKE AUDIT COMPLIANCE FOLDERS

Personalised folder bearing your branding. These are printed in-house and shipped FOC within 3 business days of initial request. Folders contain safety and technical data sheets, NSF/Ins Certificates, Allergens Statements and even a PROTEAN pad and pen.

## STORAGE SOLUTIONS

- Medium duty steel construction – quality by design
- Custom-wrapped with your branding
- Highly customisable to suit the needs of the end-user



# TYGRIS

## TYGRIS AEROSOLS

At TYGRIS we have developed a comprehensive range of Aerosols which are designed to deliver performance, reliability, efficiency, confidence and convenience in easy-to-use spray formulations. With infinite appeal, every product is designed to do the job, first time, every time, helping TYGRIS to continue to fulfil the Cleaning, Lubricating and Protecting needs of industry as we have done so since 1971.

Our aerosol range has been created to serve a variety of industries, so whether you are looking for an Automotive Aerosol to clean or protect your vehicle or perhaps line marking spray paint and applicators to give long lasting accurate markings or even plastic moulding sprays to help keep your machinery in perfect working order we've got it here at TYGRIS!



team101@tygrisindustrial.com | tygrisindustrial.com



## TYGRIS GREASES & OILS

At TYGRIS we have spent years developing our range of Grease & Oils in order to provide you with the best solutions to perform under the most extreme conditions. Our specialist designed greases are made for applications subjected to, but not restricted to, low or high temperatures and extreme pressures or conditions. Our greases offer high chemical and corrosion resistance and deliver a superior, yet affordable, solution for all your grease needs. We have food safe greases, general purposes greases, anti-seize greases as well as many others plus grease gun applicators too!



## PAINTS & COATINGS

TYGRIS VariSpray paint is a professional formulation paint developed for the effective finishing of treated and untreated materials such as metal, aluminium, glass, stone and various types of plastics whilst providing beneficial features for the user. The VariSpray corrosion preventative formulation stands it apart from typical paints and provides the protection required to ensure a long lasting finish.

Our Paints & Coatings range has been created to serve a variety of industries, so whether you are looking for an aerosol for Line Markings to apply semi-permanent markings to most hard surfaces, inside or outside, or perhaps Spray Paint with a high temperature range which is suitable for use on engine blocks, exhaust manifolds, brake drums, wood burning stoves, boiler flue pipes and in many other instances we've got it here at TYGRIS!



LUB & MAIN

## BULK

At TYGRIS we continue to work with industry leaders to provide our leading products in the most efficient delivery containers which is why we also offer our bulk 205 & 1000 Litre containers for heavy users. Save costs with our increased capacity storage containers and ensure that you always have plenty of reserves.

- Our complete range of Food Grade Greases and many of our MRO Greases & Oils are all available upon request in these sizes.

**CALL: 01294 311066**

team101@tygrisindustrial.com | tygrisindustrial.com

# INDUSTRIAL WIPES

We are proud to offer our range of Industrial Wipes, OneWipe. Designed for heavy duty use in any industrial or domestic setting our hand wipes are formulated with the highest quality ingredients to ensure they remove dirt, grime, oil and germs! Our extensive range of wipes include OneWipe Engineer's Wipes which are a specialist product perfect for removing the toughest of residue from your hands or surfaces

LUB & MAIN

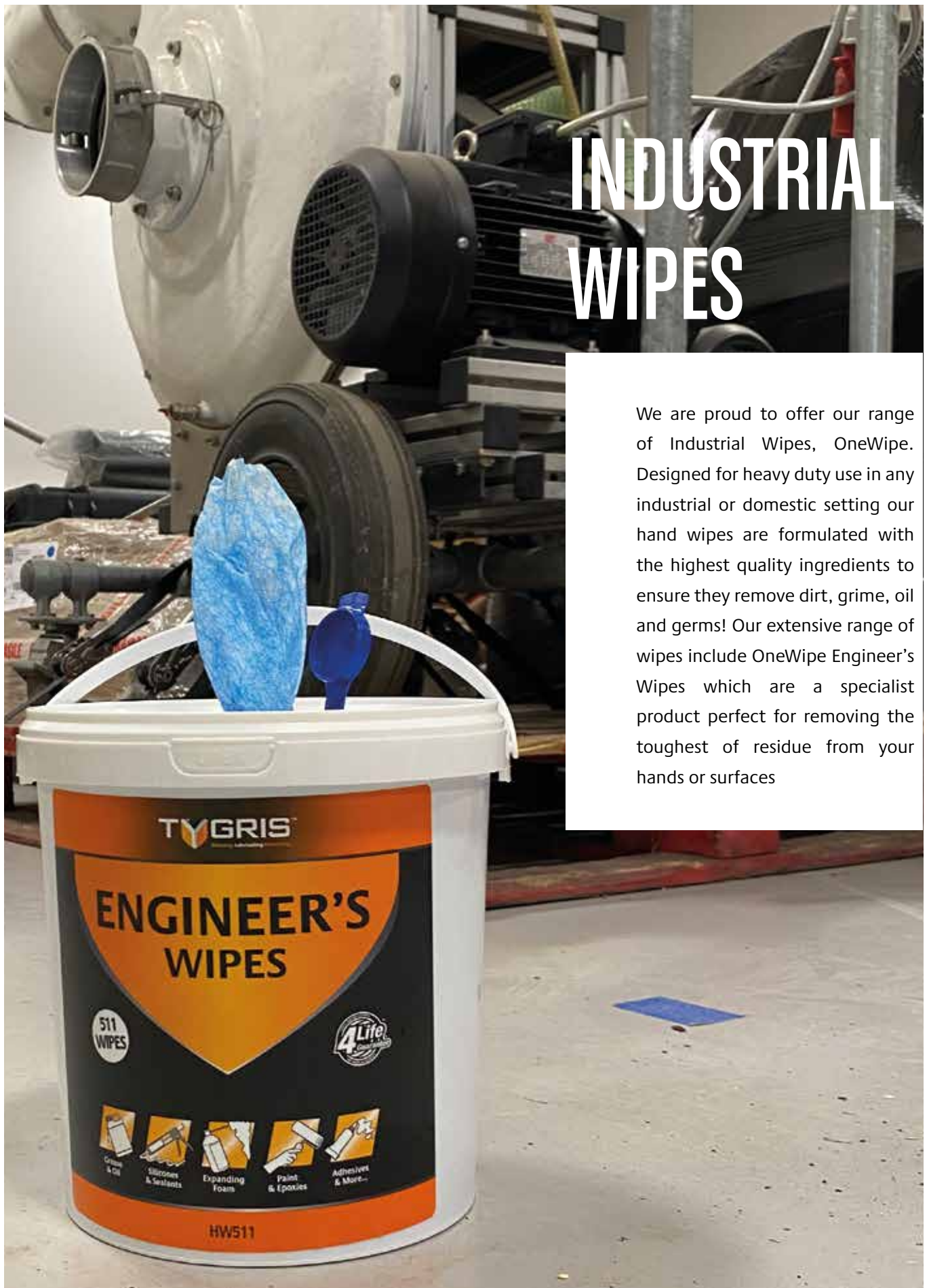



By CRC Industries

## VALUE ADDED:

- ▶ UK Manufacturer & chemicals specialist
- ▶ Nationwide regional Sales Managers
- ▶ Auto-Update SDS with My Ambersil
- ▶ Audit compliance with GREENLIGHT
- ▶ Multiple industrial approvals

LUB & MAIN

PRODUCT TYPE	INDUSTRIAL MRO	FOOD PROCESSING SAFE	WAREHOUSING & LOGISTICS	MASS TRANSIT	POWER GENERATION
GENERAL DEGREASER	<b>AMBERKLENE FE10</b> <ul style="list-style-type: none"> <li>Use for the general degreasing of machinery including chains, gears, bearings, drives, motors, and more.</li> </ul>	<b>Industrial Degreaser FG</b> <ul style="list-style-type: none"> <li>Formulated for use in the food/beverage industry to tackle 'difficult' degreasing applications. Excellent general purpose solvent degreaser.</li> </ul>	<b>AMBERKLENE FE10</b> <ul style="list-style-type: none"> <li>Use for the general degreasing of machinery including chains, gears, bearings, drives, motors, and more.</li> </ul>	<b>AMBERKLENE ME20</b> <ul style="list-style-type: none"> <li>Formulated with a slower evaporation rate for longer contact time on heavy grease and old lubricant deposits.</li> </ul>	<b>AMBERKLENE LO30</b> <ul style="list-style-type: none"> <li>Use for general light degreasing on bearings, motors, gears &amp; chains without the traditional odour associated with solvent degreasers.</li> </ul>
CONTACT CLEANER	<b>Contact Cleaner FG</b> <ul style="list-style-type: none"> <li>Designed for electrical component maintenance in the food industry, particularly for on-line production electrics and similar delicate equipment.</li> </ul>	<b>Contact Cleaner FG</b> <ul style="list-style-type: none"> <li>Designed for electrical component maintenance in the food industry, particularly for on-line production electrics and similar delicate equipment.</li> </ul>	<b>Ambertron</b> <ul style="list-style-type: none"> <li>Ultra pure formulation for critical maintenance. Removes light oils and contamination safely from PCB's, relays, all electrical contacts, switches, and more.</li> </ul>	<b>Ambertron</b> <ul style="list-style-type: none"> <li>Ultra pure formulation for critical maintenance. Removes light oils and contamination safely from PCB's, relays, all electrical contacts, switches, and more.</li> </ul>	<b>Ambertron</b> <ul style="list-style-type: none"> <li>Ultra pure formulation for critical maintenance. Removes light oils and contamination safely from PCB's, relays, all electrical contacts, switches, and more.</li> </ul>
GENERAL LUBRICANT	<b>40+</b> <ul style="list-style-type: none"> <li>A true multi-purpose 'cure-all' for engineers: use as a dewatering fluid, a penetrant on seized fasteners, a general lubricant, and as a corrosion inhibitor.</li> </ul>	<b>Machine Oil FG</b> <ul style="list-style-type: none"> <li>For use in the food industry as a highly effective metal-to-metal lubricating film.</li> </ul>	<b>40+</b> <ul style="list-style-type: none"> <li>A true multi-purpose 'cure-all' for engineers: use as a dewatering fluid, a penetrant on seized fasteners, a general lubricant, and as a corrosion inhibitor.</li> </ul>	<b>40+</b> <ul style="list-style-type: none"> <li>A true multi-purpose 'cure-all' for engineers: use as a dewatering fluid, a penetrant on seized fasteners, a general lubricant, and as a corrosion inhibitor.</li> </ul>	<b>PX24</b> <ul style="list-style-type: none"> <li>Exceptional multi-purpose lubricant formulated to military specifications. It offers excellent materials compatibility, good lubrication as a machine oil, total moisture displacement and medium-term corrosion protection.</li> </ul>
PENETRATING OIL	<b>Penetrating Oil</b> <ul style="list-style-type: none"> <li>Use as a highly effective release agent for all types of seized fasteners.</li> </ul>	<b>Penetrating Oil FG</b> <ul style="list-style-type: none"> <li>For use in the food &amp; beverage industry on fasteners seized by heat, corrosion, over-tightening and contamination.</li> </ul>	<b>Penetrating Oil</b> <ul style="list-style-type: none"> <li>Use as a highly effective release agent for all types of seized fasteners.</li> </ul>	<b>Penetrating Oil</b> <ul style="list-style-type: none"> <li>Use as a highly effective release agent for all types of seized fasteners.</li> </ul>	<b>Penetrating Oil</b> <ul style="list-style-type: none"> <li>Use as a highly effective release agent for all types of seized fasteners.</li> </ul>
SILICONE LUBRICANT	<b>Silicone Lubricant</b> <ul style="list-style-type: none"> <li>Use for plastic-to-plastic lubrication and as a highly effective friction inhibitor on chutes and slides. Ideal for use on tight plastic pipe fittings, or as a cutting aid on paper/textile blades.</li> </ul>	<b>Silicone FG</b> <ul style="list-style-type: none"> <li>Use where friction reduction is required particularly plastic-to-plastic components, on guide rails or as a label adhesive anti-stick treatment to dramatically reduce label adhesive build-up.</li> </ul>	<b>Silicone Lubricant</b> <ul style="list-style-type: none"> <li>Use for plastic-to-plastic lubrication and as a highly effective friction inhibitor on chutes and slides. Ideal for use on tight plastic pipe fittings, or as a cutting aid on paper/textile blades.</li> </ul>	<b>AMS4 Silicone Grease</b> <ul style="list-style-type: none"> <li>Military &amp; aviation grade XG250 silicone grease for use on rubber seals to prevent cracking, on 3-phase connectors to prevent moisture ingress and for general lubrication.</li> </ul>	<b>Silicone Lubricant</b> <ul style="list-style-type: none"> <li>Use for plastic-to-plastic lubrication and as a highly effective friction inhibitor on chutes and slides. Ideal for use on tight plastic pipe fittings, or as a cutting aid on paper/textile blades.</li> </ul>



PRODUCT TYPE	INDUSTRIAL MRO	FOOD PROCESSING SAFE	WAREHOUSING & LOGISTICS	MASS TRANSIT	POWER GENERATION
METAL CUTTING SPRAY	<b>Tufcut Spray</b> <ul style="list-style-type: none"> <li>The original Tufcut liquid, in an aerosol. Allows heavier close tolerance cuts, improves heat dissipation and prevents chip welding.</li> </ul>	<b>Tufcut Spray</b> <ul style="list-style-type: none"> <li>The original Tufcut liquid, in an aerosol. Allows heavier close tolerance cuts, improves heat dissipation and prevents chip welding.</li> </ul>	<b>Tufcut Foam</b> <ul style="list-style-type: none"> <li>Proven Tufcut liquid in a foam that clings to vertical surfaces. Ideal for maintenance of turbine blades, minimal smoking &amp; fumes in use.</li> </ul>	<b>Tufcut Spray</b> <ul style="list-style-type: none"> <li>The original Tufcut liquid, in an aerosol. Allows heavier close tolerance cuts, improves heat dissipation and prevents chip welding.</li> </ul>	<b>Tufcut Foam</b> <ul style="list-style-type: none"> <li>Proven Tufcut liquid in a foam that clings to vertical surfaces. Ideal for maintenance of turbine blades, minimal smoking &amp; fumes in use.</li> </ul>
CHAIN SPRAY	<b>Chainspray</b> <ul style="list-style-type: none"> <li>Use on all types of drive chains, including production line, door mechanisms, quarry plant, and drying oven doors.</li> </ul>	<b>Chain Lube FG</b> <ul style="list-style-type: none"> <li>Ideal for all types of chains and chain driven drive systems. The addition of PTFE to the lubricant enhances long-term chain lubrication.</li> </ul>	<b>Chainspray</b> <ul style="list-style-type: none"> <li>Use on all types of drive chains, including production line, door mechanisms, quarry plant, and drying oven doors.</li> </ul>	<b>Chainspray</b> <ul style="list-style-type: none"> <li>Use on all types of drive chains, including production line, door mechanisms, quarry plant, and drying oven doors.</li> </ul>	<b>Chainspray</b> <ul style="list-style-type: none"> <li>Use on all types of drive chains, including production line, door mechanisms, quarry plant, and drying oven doors.</li> </ul>
ANTI-SEIZE	<b>Copper Anti-Seize</b> <ul style="list-style-type: none"> <li>Use on threaded fasteners to prevent seizing during prolonged maintenance intervals, in hostile/high humidity environments, and areas subjected to high temperatures.</li> </ul>	<b>Assembly Paste FG</b> <ul style="list-style-type: none"> <li>Use in the same manner as a traditional Copper Anti-Seize on fasteners, or as a running-in compound for bearings. The non-metallic solids content make this product suitable for use in the food industry.</li> </ul>	<b>Copper Anti-Seize</b> <ul style="list-style-type: none"> <li>Use on threaded fasteners to prevent seizing during prolonged maintenance intervals, in hostile/high humidity environments, and areas subjected to high temperatures.</li> </ul>	<b>Copper Anti-Seize</b> <ul style="list-style-type: none"> <li>Use on threaded fasteners to prevent seizing during prolonged maintenance intervals, in hostile/high humidity environments, and areas subjected to high temperatures.</li> </ul>	<b>Assembly Paste FG</b> <ul style="list-style-type: none"> <li>Use in the same manner as a traditional Copper Anti-Seize on fasteners, or as a running-in compound for bearings. The non-metallic solids content make this product suitable for use in the food industry.</li> </ul>
CORROSION PROTECTION	<b>Acrylic Paint</b> <ul style="list-style-type: none"> <li>RAL colour matched vibrant acrylic paint for the repair and touch-up of painted surfaces.</li> </ul>	<b>Clear Mould Protective</b> <ul style="list-style-type: none"> <li>Tenacious and long-lasting anti-corrosion treatment for mould tools. The highly visible green spray provides easy visual inspection to ensure complete coverage.</li> </ul>	<b>Galva Colour</b> <ul style="list-style-type: none"> <li>Use on surfaces which have surface rust, old paint or otherwise 'imperfect' finish.</li> </ul>	<b>Cold Galvanise</b> <ul style="list-style-type: none"> <li>Provides cathodic protection to ferrous metals. Ideal for pipes, housings, structural metal, and as a primer. Particularly suited for protecting drilled or abraded surfaces.</li> </ul>	<b>Bright Cold Galvanise</b> <ul style="list-style-type: none"> <li>Aesthetic anti-corrosion paint for freshly galvanised steel – weathers at the same rate for 'invisible' repairs.</li> </ul>
WIPES	<b>Tough Wipes</b> <ul style="list-style-type: none"> <li>High absorbency hand wipes over-layered with a polymer web for all the deep cleaning power of pumice in a handy wipe.</li> </ul>	N/A	<b>Tough Wipes</b> <ul style="list-style-type: none"> <li>High absorbency hand wipes over-layered with a polymer web for all the deep cleaning power of pumice in a handy wipe.</li> </ul>	<b>Tough Wipes</b> <ul style="list-style-type: none"> <li>High absorbency hand wipes over-layered with a polymer web for all the deep cleaning power of pumice in a handy wipe.</li> </ul>	<b>Tough Wipes</b> <ul style="list-style-type: none"> <li>High absorbency hand wipes over-layered with a polymer web for all the deep cleaning power of pumice in a handy wipe.</li> </ul>
BEARING GREASE	<b>Ambergrease EXL</b> <ul style="list-style-type: none"> <li>Use on critical, high load bearings and sliding surfaces. Ideal for use in applications where a longer than usual in-service life is required.</li> </ul>	<b>Ambergrease FG1/2/3</b> <ul style="list-style-type: none"> <li>NLGI 2 greases in cartridge or aerosol format for low temperature, high temperature, high load, or general use.</li> </ul>	<b>Ambergrease EXL</b> <ul style="list-style-type: none"> <li>Use on critical, high load bearings and sliding surfaces. Ideal for use in applications where a longer than usual in-service life is required.</li> </ul>	<b>Ambergrease EXL</b> <ul style="list-style-type: none"> <li>Use on critical, high load bearings and sliding surfaces. Ideal for use in applications where a longer than usual in-service life is required.</li> </ul>	<b>Ambergrease EXL</b> <ul style="list-style-type: none"> <li>Use on critical, high load bearings and sliding surfaces. Ideal for use in applications where a longer than usual in-service life is required.</li> </ul>







As a Lubricant provider with 17 years of manufacturing and blending experience **NewTechLubes** has always stuck to the same basic principles, to offer **excellent products at sensible prices backed by excellent customer service.**

## Confidence through colour

MISTAKES CAN BE COSTLY, PREVENTION MADE SIMPLE

Focussing on your needs, we have developed a way of providing, for any size of production site, an easy system of identification for products and applications that is fully scalable with growth.

There are several elements that go together to enable this system to work. These are undertaken by our network of reliable distributors giving you a personal point of contact to take you from where you are currently at to an audit ready and organised site within a very short timeframe:

- Site Survey
- Site Report & Proposal
- Products
- Storage and Dispensing Systems
- Compliance Manual

This colour coded system offers you as the user many benefits:

- Visual Identification of correct lubricant for each piece of machinery
- Dedicated equipment to prevent cross contamination
- Easy training of staff to follow maintenance schedules
- Easy Audit Compliance
- Follow Best Practices - Reduce Risks
- Avoid Costly Contamination or Recalls



MEAT | DAIRY | DRINK | FOOD PACKAGING | PHARMACEUTICAL | PRE-PACK FOOD | BAKERY



## NTECH LUBE KART

The New Tech Lubes Lubrication Kart is the solution to provide an effective way to keep your workspace clean, efficient and safe.

It has been designed to be adaptable to your lubrication requirements. The top storage tray is perfect for Grease Guns and tools, with plenty of space for gloves and other equipment. All aerosols, grease cartridges and/or tools can be stored in the lockable cabinet.

The **NTECH** Lubrication Kart is a compact unit which keeps all your equipment close to hand.

**NTECH** Lube Kart features:

- Lockable cabinet for lubricants, aerosols and tools
- Paper roll dispenser, clean rag and pull-out waste bin
- Detachable pump bucket holding tray/dispensing well
- Tray for dispensing equipment
- Tool tray



## NTECH LUBE STATION

The New Tech Lubes Lubrication Station is the solution to provide a unique cost effective way to store and dispense your lubricants whilst being audit-friendly to keep track of your consumption.

It has also been designed to be flexible and allows for growth. The station comprises of 3 components which can be arranged in a variety of ways. The Sump Base to collect any drips or spills during refilling/decanting.

The Intermediate Units can store your lubricant containers and application jugs, and finally the Aerosol Cabinet, a lockable unit to add that necessary extra level of security/protection for pressurised containers and volatile chemicals/cleaners etc.

The **NTECH** Lubrication Station is a modular system which allows for more units to be added so it can adapt to the demands of your business.

**NTECH** Lube Station features:

- Modular, robust construction
- Tough, durable finish, also available in Stainless Steel
- Fully bonded with self-draining shelves
- Lockable aerosol & grease cabinet
- Easy clean sump with removable grids
- Fits any size/shape 20-25Ltr containers
- Accommodates pumps on the sump unit
- Disappearing door when open
- Build it exactly how you want it
- No tools required for assembly

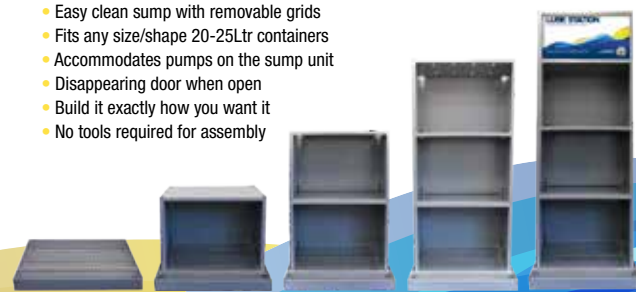

Component Dimensions	Width	Depth	Height
Station Tray	775mm	700mm	80mm
Station Intermediate Unit	750mm	500mm	525mm
Station Aerosol Cabinet	750mm	500mm	380mm



LUB & MAIN

For further information, technical documents or to begin the colour and compliance process please contact your local IADA branch representative.



**New Tech Lubes Ltd**



## NTL COLOUR COMPLIANCE

The **Oil Safe** colour combination system is known around the world as the oil transfer management system preferred by leading companies. Colour-coding your lubricants, greases and fluids will improve efficiency, reduce downtime and make dispensing easy whilst preventing cross contamination and misapplication.

With 5 different lid types designed to fit each of the 5 different drum sizes, you can mix and match the components to build heavy duty durable containers that will meet your oil transfer requirements.

**Oil Safe** products are available in 10 colours:



- Utility Lid
  - Stretch Spout Lid
  - Mini Spout Lid
  - Storage Lid
  - Premium Pumps
  - See-through Graduated Drums\*
- \* available sizes: 1.5L, 2L, 3L, 5L or 10Liter/US quart drum



**Oil Safe**

Designed to work alongside the **Oil Safe** range of handling equipment, our label colours match up to allow dedicated and identifiable decanting equipment tailored to the job in hand. With a range of container sizes and dispensing lids there is an option for all tasks.



### FOOD SAFE HYDRAULIC OIL

#### FS HYD OIL

Manufactured using high performance synthetic base oils to allow wide operating temperatures and maximum performance. FS Hyd Oils are suitable for hydraulic systems within the food industry.

#### Benefits

- Clean lubricating oil
- Can be used in food and pharmaceutical production facilities
- Hydrophobic, will not emulsify
- Wide temperature range. -20°C to 180°C
- Suitable for use in food, beverage, pharmaceutical and clean environments
- NSF H1 Registered, made with FDA listed ingredients

Operating Temperature	-20°C to 180°C		
Available Grades	32	46	68
Sizes Available	5Ltr	20Ltr	205Ltr

### FOOD SAFE GEAR OIL

#### FS CLEAR GEAR

Manufactured using high performance synthetic base oils to allow wide operating temperatures and maximum performance. FS Clear Gear Oils are suitable for all gearboxes within the food industry.

#### Benefits

- Clean lubricating oil
- Can be used in food and pharmaceutical production facilities
- Hydrophobic, will not emulsify
- Wide temperature range. -20°C to 180°C
- Suitable for use in food, beverage, pharmaceutical and clean environments
- NSF H1 Registered, made with FDA listed ingredients

Operating Temperature	-20°C to 180°C			
Available Grades	150	220	360	460
Sizes Available	5Ltr	20Ltr	205Ltr	

### FOOD SAFE SYNTHETIC COMPRESSOR OIL

#### FS COMP TECH

Manufactured using high performance synthetic base oils to allow wide operating temperatures and maximum performance. FS Comp Tech Oils are suitable for Compressor systems within the food industry.

#### Benefits

- Clean lubricating oil
- Can be used in food and pharmaceutical production facilities
- Hydrophobic, will not emulsify
- Wide temperature range. -20°C to 180°C
- Suitable for use in food, beverage, pharmaceutical and clean environments
- NSF H1 Registered, made with FDA listed ingredients

Operating Temperature	-20°C to 180°C		
Available Grades	46	68	100
Sizes Available	5Ltr	20Ltr	205Ltr

## INTRODUCING NTL SMART AEROSOLS

All NTL aerosols are being supplied with smart straw technology. Giving the option of a heavy spray or direct jet this versatile cap is non-removable to prevent foreign objects making their way into the production line. Smart aerosols are available in:

- FS EXTRA
- FS TROJAN
- FS SILL-TECH
- FOODGUARD 3H
- FS LUBE-FLOW
- FS BELT TECH
- FS ELEC-TECH
- FS RELEASE 3H
- FS DEGREASER
- FS EASE
- FS CHAIN-TECH





## NTL FOOD SAFE RANGE

When safety and quality are the top priority our range of food grade lubricants are tough to beat. Made using all FDA Listed ingredients, and free of known allergens, every product in this range is NSF Registered and nearly all come with Kosher and Halal approval.



Bulk option



Aerosol option

### FOOD SAFE FSW GREASE

FSW is a multipurpose grease for use in food and pharmaceutical production areas. Excellent Water resistance and EP properties provide long term protection from corrosion and wear. Its adhesive formula prevents wash off and reduces lubricant usage. It is suitable for all types of ball, roller and plain bearings. FSW is manufactured using only FDA listed ingredients and is H1 registered.

Operating Temperature	-10°C to 150°C
Available Grades	NLGI 2

### FOOD SAFE FS EXTRA

FS Extra is the ultimate clean environment grease. This translucent grease is constructed using pure synthetic base oils, combined with PTFE and a complex mix of antioxidant and EP packages. Its hydrophobic nature makes it ideal in wet environments or where cleaning takes place.

Operating Temperature	-40°C to 260°C
Available Grades	NLGI 000 NLGI 0 NLGI 1 NLGI 2 NLGI 3

### FOOD SAFE FS TROJAN

Provides superior heavy duty performance with exceptional load abilities. Based on Aluminium complex thickeners with synthetic base oils it has outstanding temperature ability and water resistance. Its performance under pressure makes it the ideal choice for most food applications and auto-lube systems in bakeries, meat processing plants, production lines, packaging facilities and dairy manufacture etc.

Operating Temperature	-40°C to 240°C
Available Grades	NLGI 000 NLGI 0 NLGI 1 NLGI 2 NLGI 3

### FOOD SAFE FS SILL TECH

A versatile silicone grease for operation in extremes of high and low temperature. FS Sill-Tech Grease can also be used on food production applications, water pipes, O-Rings, to waterproof electrical devices or as a lubricant where water repellent properties are of prime importance.



Operating Temperature	-50°C to 280°C
Available Grades	NLGI 2

### FOOD SAFE FS GLACIER

FS Glacier is designed for the demanding role of lubricating low temperature environments. Its low base oil viscosity and operating temperature range make it the perfect choice for bearing lubrication in refrigerated production plants, freezers or in cold climates. The inclusion of hydrophobic oils and PTFE provide protection from moisture and increased lubricity.

Operating Temperature	-60°C to 185°C
Available Grades	NLGI 2

### FOOD SAFE FS DURA TECH

Fluorinated grease with PTFE. Used in demanding and critical applications including oxygen rich, vacuum, harsh chemical, sealed for life and high temperature applications.

Operating Temperature	-25°C to 300°C
Available Grades	NLGI 2

### FOOD SAFE FS AIRLINE

Low viscosity airline lubricant for use with all air tools and air lines.

Operating Temperature	-10°C to 150°C
Available Viscosity	32cst

### FOOD SAFE FS LUBE FLOW

Universal lubricating oil for use on many applications including chains, pivot points and sliding surfaces. It is highly water resistant to protect against corrosion and to resist wash off.

Operating Temperature	-40°C to 260°C
Available Viscosity	46cst

### FOOD SAFE FS LUBE FLOW PTFE

Highly tenacious chain lubricant containing PTFE for lubrication of chains in the food industry. Good adhesion reduces lubricant usage.

Available in Aerosol as FS CHAIN TECH

Operating Temperature	-40°C to 260°C
Available Viscosity	260cst

### FOOD SAFE FS SILL TECH OIL

Pure, non toxic silicone fluids for use in applications such as lubricating sliding services and heat transfer applications. \* 350cst - NSF H1 registered, made with FDA listed ingredients

Operating Temperature	-40°C to 250°C
Available Viscosity	50cst 350cst*

### FOOD SAFE FS GL

FS GL gear oils are designed for use in worm and wheel gear systems, they are also suitable for conventional gear boxes in and out of the food industry.

Operating Temperature	-30°C to 180°C
Available Viscosity	150 460 220 - 360 -

### FOOD SAFE FS CHAIN COAT

Solvent delivered chain lube for use in wet areas for the lubrication of pivot points and chains, highly resistant to wash off giving a high degree of protection to water soaked equipment in environments such as dairies and abattoirs.

Operating Temperature	-40°C to 250°C
Available Viscosity	-

### FOOD SAFE FS ANTI-SEIZE

Containing a high percentage of solid lubricants such as PTFE combined with synthetic base oil and highly water resistant thickener this product has been designed to aid assembly and disassembly of components and reduces fretting corrosion between mating surfaces.

### FOOD SAFE FS BELT TECH

Designed to reduce slippage of factory conveyors operating in wet environments or after cleaning. Increases adhesion between belts and pulleys to enable full power to be transmitted and smooth, continuous belt operation. Aerosol spray allows easy and consistent application to the underside of belts.

### FOOD SAFE FS EASE

FS Ease is a food grade penetrating and dismantling fluid for use on seized parts. After the penetrating solvents evaporate a protective, hydrophobic oil coating is left behind to prevent further corrosion.

### FOOD SAFE FS MULTI-LUBE

As an alternative to aerosol maintenance products this multi purpose fluid penetrates, lubricates and protects. Consisting of a solvent carrier and highly adhesive water resistant Base oils, combined EP additives and dewatering agents. Supplied in trigger spray bottles for manual application. Ideal for application to chains and moving parts.

### FOOD SAFE FS ELEC-TECH

Fast evaporating cleaning fluid for use on switches and contacts. Degreases and cleans surfaces leaving a protective corrosion resistant coating in place.

NOT FOR USE ON LIVE ELECTRICS

### FOOD SAFE FS DEGREASER

FS-Degreaser is an all-purpose cleaner designed for food production areas. Clean in use our FS Degreaser is low odour and fast evaporating leaving no residue or deposits behind.

For further information, technical documents or to begin the colour and compliance process please contact your local IADA branch representative.



New Tech Lubes Ltd



## NTL GREASES AND LUBRICANTS

Making the right selection when it comes to lubrication is the most important decision in the chain. Having a product with the properties and materials designed to function in your environment is essential in preventing costly down time and unnecessary repairs. That is why, whether you are looking at extremes of temperature, load, speed or moisture we have a product suitable for your needs.



LUB & MAIN

### GREASES & LUBRICANTS MULTI-LUBE

Lithium soap E.P grease for use in heavily loaded anti-friction and plain bearing applications. Multi-Lube is the ideal grease for many situations making it an invaluable addition to your stores or toolbox. Suitable for use in lubrication systems.

Operating Temperature	-20°C to 140°C	
Available Grades	NLGI 000 NLGI 00	NLGI 0 NLGI 1 NLGI 2 NLGI 3

### GREASES & LUBRICANTS HI-LOAD

High-Load Grease is a high performance, multipurpose grease developed to simplify maintenance lubrication. It is suitable for all types of ball, roller and plain bearings and enables a reduction in the number of different types of greases kept in the stores. With the inclusion of MoS2, High Load gives excellent high load carrying properties that standard multipurpose greases cannot deliver.

Operating Temperature	-20°C to 140°C	
Available Grades	NLGI 2	

### GREASES & LUBRICANTS MLR

MLR is a premium quality, multipurpose, lithium complex grease for all plain and anti-friction bearings. Its red colour easily sets it apart from other products and allows instant identification.

Operating Temperature	-30°C to 160°C	
Available Grades	NLGI 2	

### GREASES & LUBRICANTS MLR-M

Based on our popular MLR grease with the addition of MoS2 to increase load ability for the most arduous conditions. Ideally suited to heavy plant equipment or applications with increased load and vibrations.

Operating Temperature	-30°C to 160°C	
Available Grades	NLGI 2	

All Greases available in Lube Shuttles

### GREASES & LUBRICANTS HI-TEMP

Hi-Temp is designed for the lubrication of bearings operating at elevated temperatures. Its non-melting base provides great stability, preventing softening under heavy loads. Contains MoS2 and Graphite for optimal protection at higher temperatures.

Operating Temperature	-10°C to 190°C	
Available Grades	NLGI 2	

### GREASES & LUBRICANTS TITAN

Titan is a synthetic non-melting grease designed for when protection is needed at extremes of temperature. Its ability to perform in harsh environments makes it ideal for use in kilns, foundries, steel works and potteries etc.

Operating Temperature	-30°C to 270°C	
Available Grades	NLGI 1	NLGI 2

### GREASES & LUBRICANTS TITAN M

Titan is a synthetic non-melting grease designed for when protection is needed at extremes of temperature. Its ability to perform in harsh environments makes it ideal for use in kilns, foundries, steel works and potteries etc.

Available in NLGI 1, suitable for auto lube system in rotational moulding plants.

Operating Temperature	-30°C to 270°C	
Available Grades	NLGI 1	NLGI 2

### GREASES & LUBRICANTS SIREN

Siren Grease is a synthetic, long life, complex grease containing extreme pressure additives designed to withstand high load. It also contains PTFE to reduce friction and internally generated temperatures.

Operating Temperature	-50°C to 250°C	
Available Grades	NLGI 2	

### GREASES & LUBRICANTS SIREN M

Based on our Siren grease with the addition of MoS2 to increase load ability for the most arduous conditions. Siren M is a synthetic, long life, complex grease with MoS2 and EP additives designed to withstand high loads. It also contains PTFE to reduce friction and internally generated temperatures.

Operating Temperature	-50°C to 250°C	
Available Grades	NLGI 2	

### GREASES & LUBRICANTS HI-SPEED ULTRA

Barium complex grease containing synthetic oils for use as a low temperature, high speed grease providing high resistance to aging, water wash out, hot water, vapour, acid and alkaline solutions etc. High speed ultra is designed for lathes, chucks, CNC machines and high speed spindles.

Operating Temperature	-40°C to 150°C	
Available Grades	NLGI 2	

### GREASES & LUBRICANTS POLY-TECH B

Poly-Tech B is a premium quality, all round, long life grease designed for use in bearings and other applications subject to elevated temperature and high speeds. Poly-Tech B is ideally suited to wet environments as it has excellent water resistance.

Operating Temperature	-25°C to 180°C	
Available Grades	NLGI 1	

### GREASES & LUBRICANTS FS DURA-TECH

FS Dura-Tech is a product, which uses the latest grease technology and technical developments to deliver high performance under the most extreme conditions of load and temperature. Dura-Tech is a perfluoroether, the highest quality available of all PTFE greases.

Operating Temperature	-25°C to 300°C	
Available Grades	-	

### GREASES & LUBRICANTS RED RUBBER

Red Rubber Grease is a premium quality, biodegradable, Bentone thickened automotive grease for use in hydraulic systems and especially braking systems, where compatibility with natural, Styrene Butadiene (SBR), and other types of rubber seal is desirable.

Operating Temperature	-5°C to 120°C	
Available Grades	NLGI 2	

### GREASES & LUBRICANTS SOLO EP

Solo EP is a premium quality, calcium sulphonate lubricating grease for use in severe conditions; the product is highly water repellent and has good chemical resistance. The excellent EP ability and high base oil viscosity of this product makes it ideal for use in press applications including wood pellet, tablet and animal feed.

Operating Temperature	-30°C to 180°C	
Available Grades	NLGI 2	

### GREASES & LUBRICANTS SALT RESISTANT

Salt resistance grease is premium semi-synthetic, water proof grease designed specifically for slow to medium speed plain and anti-friction bearing applications in marine and other hostile environments. Suitable for use on Motor bearings, turbines, generators and boat stern tubes.

Operating Temperature	0°C to 140°C	
Available Grades	NLGI 1	NLGI 2

### GREASES & LUBRICANTS HI-GRAF

Hi-Graf Grease is synthetic grease based on PAG technology with MoS2 & Graphite added in a complex additive system. Formulated to operate at high temperatures which would break down the structure of normal high temperature greases, Hi-Graf is designed to operate in conditions of load and corrosion far above most synthetic greases.

Operating Temperature	-4°C to 250°C	
Available Grades	NLGI 2	



## NTL MAINTENANCE RANGE

New Tech Lubes manufactures a range of high quality workshop consumables aiding in assembly and dismantling, manufacture and cleaning of products and components.



LUB & MAIN

### MAINTENANCE HI-TACK CHAIN OIL

Designed to reduce "fling off" associated with standard chain oils. Provides exceptional anti-wear and anti-friction properties. Penetrates deep into links and pins for maximum effect. High viscosity base oil to improve shock loading ability. Protects chains from corrosion.

### MAINTENANCE BRAKE & CLUTCH CLEANER

Designed to remove oil, grease, brake fluid and other dirt from metal parts. Restore the friction of brake and clutch lining material. Fast, clean drying, leaves no residue. Eliminates brake squeal and clutch slip. Suitable for other mechanical parts of the vehicle.

### MAINTENANCE WHITE MAINTENANCE GREASE

Designed to provide lubrication for all moving parts including locks, pivots, chains, bearings, cables & slides. Prevents corrosion and attack from water. Applies evenly as a fluid and sets to a fully formed grease. Clean in use, white grease, with white EP additives to prevent black staining and unnecessary mess. Suitable for marine applications.

### MAINTENANCE COPPER ANTI SEIZE

Designed to prevent component seizure in arduous conditions. Provides long term protection against corrosion. Lubricates threads for easy dismantling. Allow re-use of parts after disassembly. Applied as a fluid for maximum coverage of fine components. Non-melting, so can be used on braking systems.

### MAINTENANCE CITRUS DEGREASER

Powerful citrus degreaser designed to breakdown grease and grime on many surface for easy removal. Citrus fragrance and natural extracts leave work areas clean and fresh smelling. Non staining. Can also be used to remove certain labels and adhesives.

### MAINTENANCE CUTTING & TAPPING FLUID

Designed to reduce friction. Increase metal removal speeds and extend the life of the tools' cutting edge resulting in an improved surface finish and accuracy. Containing Ultra EP additives.

### MAINTENANCE SILICONE SPRAY

Designed to release plastic moulds with ease and lubricate small mechanisms, cables, hinges and other parts to prevent seizure and squeaks. Leaves a light coating to protect from water and corrosion. Applies as a fluid but dries to a non-wet coating. Clean in use, water white, non staining.

### MAINTENANCE OPEN GEAR & ROPE GREASE

Formulated to operate in dry and wet environments. Once applied it forms a protective grease film containing high load additives. Tenacious nature and adhesive properties reduce "fling off". Contains MoS2 and Graphite for resisting high loads and temperatures. High water resistance prevents corrosion and seizure in all weathers.

### MAINTENANCE PENETRATING FLUID

Designed to penetrate quickly into the most corroded components. Lubricates hinges, locks, fasteners and cables etc. Releases seized nuts, bolts and components. Displaces water and protects against corrosion. Gives long term, low friction effect using PTFE micro particles.

### MAINTENANCE DRY PTFE FILM

Designed to provide a film of high quality bonded PTFE to reduce the friction of most surfaces. It is suitable for use as a non stick agent on many surfaces including chutes and slides. It's non staining formula makes it ideal for clean environments. It is also suitable as a light lubricant on delicate mechanisms, pins, cams and guides.

**LARGER VOLUME CAN 500ml**



## NTL ANTI-SEIZE, CUTTING & CLEANING

### MAINTENANCE ANTI-SEIZE RANGE

New Tech Lubes provide a range of anti seize pastes suitable for protecting various materials and threaded components up to 1400°C ensuring easy dismantling down the line. We also produce an MoS2 fortified assemble/anti scuff paste ideal for the running in of parts. These anti seize pastes have been designed for assembly and disassembly of many components used in hostile environments where corrosion, fretting corrosion and seizure are of concern. They all contain the addition of graphite to enhance dynamic as well as static properties required.

### MAINTENANCE DRY GRAF

Fast drying, bonded graphite coating used for pre-coating bearing and sliding surfaces, gaskets and forming moulds in the rubber, glass and forging sectors. Utilising a high concentrate of extremely pure colloidal graphite it can be applied by brush, spray, dipping and spray aerosol. Dry Graf is an excellent parting medium which provides protection against fretting corrosion, aids assembly, disassembly and has many other applications. **Note** - see full data before use or consult our technical department.

### MAINTENANCE PEN TECH

Fast acting penetrating and de-watering lubricant for the effective release and lubrication of all corroded and seized components. Its modern formulation which contains PTFE gives Pen Tech excellent lubrication qualities, even after the fluid film has disappeared. Works on heavily corroded parts.

### MAINTENANCE CITRO-TECH

A water soluble, multi-use, cleaner and degreaser can be used neat or diluted to clean and degrease worktops, floors, machines and even as a traffic film pre-wash on vehicles. The citrus odour makes Citro-Tech pleasant to use.

### MAINTENANCE POWER CUT PASTE & FLUID

Highly advanced, neat, cutting fluid containing EP additives and select base oils to provide a better finish and longer tool life in many applications. Available as a high performance fluid or a heavy duty paste.

Operating Temperature	Anti-Seize Product Name	Paste Colour
1100°C	COPPER TECH	COPPER
1200°C	ALUMINIUM TECH	BRIGHT SILVER
1400°C	NICKLE TECH	DARK GREY SILVER
-60°C - 650°C	MOLY TECH AP	BLACK



For further information, technical documents or to begin the colour and compliance process please contact your local IADA branch representative.

**New Tech Lubes Ltd**



**EXCELLENCE IN LUBRICANTS**

*IT'S NOT JUST OUR STRAPLINE - IT'S OUR PHILOSOPHY...*

We're the largest independent lubricants company in the UK, manufacturing and supplying a range of lubricants and associated products to automotive, commercial, agricultural, industrial, off highway & rail sectors.

Our commitment to total quality management covers everything from design to production, distribution and customer support. Throughout the company's history, our product development has been at the forefront of lubricant technology.

## **INDUSTRIAL**

Exol's extensive industrial product range has been designed to cover all the needs of machine shops and industrial plant. The range includes both neat and water miscible metal cutting and forming fluids through to machine tool lubricants and rust preventatives



Hydraulic Oils



Gear Oils



Machine & Slideway  
Oils



Compressor  
Oils



Multi-Functional  
Oils



Turbine  
Oils



Soluble Cutting &  
Grinding Oils



Neat Cutting &  
Grinding Oils



Forming Oils



Greases



Ancillary Products

## **AGRICULTURAL**

The highly developed agricultural machinery in use in today's intensive farming environment needs the specialised protection afforded by Exol's range of agricultural lubricants. Exol's agricultural product range has been developed to satisfy the requirements of the latest specialised tractors through to older types of farming machinery and ancillary equipment



Universal Oils



Engine Oils



Gear &  
Transmission Oils



Hydraulic  
Oils



Greases



Ancillary  
Products

## RAIL

Exol has a range of specialised products for use in the rail industry including heavy duty diesel engine oils, power transmission fluids and high quality greases. Exol's rail products are renowned for their long predictable service life and trouble-free operation.



Engine Oils      Gear & Transmission Oils      General Lubricating Oils      Hydraulic Oils      Greases      Ancillary Products

## COMMERCIAL

Exol's commercial vehicle lubricants satisfy the needs of the most modern trucks and buses as well as older models. The exhaustive range features low SAPS, fully synthetic engine oils, long drain semi synthetics and traditional mineral oil grades as well as sophisticated automatic transmission fluids, manual gear oils and ancillary products.



Low SAPS Engine Oils      Fully & Semi Synthetic Engine Oils      Mineral Oil Based Engine Oils      Gear & Transmission Oils      Hydraulic Oils      Greases      Ancillary Products

## OFF HIGHWAY

Exol's off-highway range of lubricants and fluids encompasses a wide variety of sectors including construction, marine and forestry. The range includes specialised transmission fluids, marine specific engine oils, biodegradable lubricants and sophisticated greases.



Engine Oils      Universal Oils      Gear & Transmission Oils      Marine Engine Oils      Gas Engine Oils      Greases

## AUTOMOTIVE

Exol's comprehensive range of automotive lubricants combine a high level of protection to engines and transmissions with long, trouble free service life. The range includes premium grade low SAPS engines oils, robust semi synthetic and mineral oil based grades and manual and automatic transmission fluids.



Low SAPS Fully Synthetic Engine Oils      Fully Synthetic Engine Oils      Semi Synthetic Engine Oils      Mineral Oil Based Engine Oils      Two Stroke Oils      Gear & Transmission Oils      Greases

Please contact your IADA Distributor for details of pack sizes and product range

### OILS AVAILABLE IN:



### GREASES AVAILABLE IN:





## EXPERTS & TOOLS A COMPLETE SOLUTION OF MAINTENANCE PRODUCTS FOR BEARINGS.



www.ntn-snr.com



With You

## TOOLS

A range of tools for the fitting and removal of bearings

### Essentials

#### Induction heating

TOOL SmartTEMP S / Induction heater



#### Hydraulic Nuts

TOOL HMV 28EBF / Hyd nut



#### Cold fitting kit

TOOL IFT SET 33 / Industry fitting tool set



#### Self-centering hydraulic pullers

TOOL SCHP 4 TONS / Self-center hyd puller



### Discover our full range

#### Internal bore puller kits

TOOL BP SET 5-44 / Bore puller set



#### External mechanical self-centering pullers

TOOL SCMP 2/3-120 / Self-center mech puller



#### Deep groove ball bearing puller kit

TOOL BBPS 10-100 / Ball bearing puller set



#### Infra-red thermometer

TOOL LASERTEMP 301 / IR thermometer



#### Anti-fretting fitting paste

LUB MOUNTING PASTE / B500G



LUB MOUNTING PASTE / T60G



#### Heat resistant gloves

TOOL GLOVE HEAT RESISTANT



For more information about our E&T range of tools: [www.ntn-snr.com](http://www.ntn-snr.com)



### LUBRICATION

LUB' SOLUTIONS, the solution to solve your lubrication problems

#### Multipoint lubrication systems

POLIPUMP



**Profitable:** increase the availability of your equipment while reducing your maintenance costs.

**Economical and efficient:** possibility of lubricating 1 to 35 points with the grease of your choice up to a distance of 20 metres.

**Easy to handle and ecological:** easy to install in 4 easy steps. Providing the correct amount of lubrication at the right time, reducing waste and ensuring parts are lubricated correctly.

#### Single point lubrication systems

READY BOOSTER / SMART BOOSTER / DRIVE BOOSTER

##### Ready Booster - economical and reliable

- Ready to use, no assembly or tools required
- Protection: IP68
- Distribution duration: between 1 and 12 months
- Operating temperature: -20 °C to +60 °C



##### Drive Booster - powerful and precise

- Powerful and precise
- Protection: IP65
- Distribution duration: between 1 and 12 months
- Operating temperature: -10 °C to +60 °C



##### Smart Booster - Efficient and technical

- Precise, ergonomic; allows a constant flow, independent of the ambient temperature
- Protection: IP65
- Distribution duration: between 1 and 12 months
- Operating temperature: -20 °C to +60 °C



LUB & MAIN



DOC\_L\_GamaE&T\_ARF02\_GBa - Non contractual document - NTN-SNR Copyright International 04/2021 - Photos : Pedro Studio Photo.

### GREASE

Find the grease that best suits your application.

#### UNIVERSAL Multi purpose

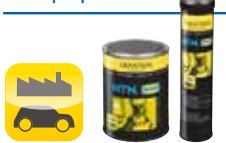

#### VIB Vibrations & shocks



#### ULTRA HIGH TEMP Extreme high temperature



#### HIGH SPEED + Spindles



#### FOOD AL Food sure

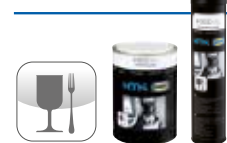

#### HEAVY DUTY High load



#### HIGH TEMP MP High temperature



#### CHAIN OIL



#### FOOD CHAIN OIL

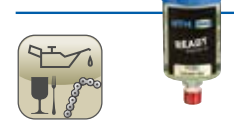

For more information about our E&T range of lubrication solutions: [www.ntn-snr.com](http://www.ntn-snr.com)



NTN-SNR ROULEMENTS - 1 rue des Usines - 74000 Anancy  
RCS ANNECY B 325 821 072 - Code APE 2815Z - Code NACE 28.15  
[www.ntn-snr.com](http://www.ntn-snr.com)

NTN BEARINGS UK LTD  
Wellington Crescent, Fradley Park,  
Lichfield, WS13 8RZ, UK.

**NTN SNR** With You

This document is the exclusive property of NTN-SNR ROULEMENTS. Any total or partial reproduction hereof without the prior consent of NTN-SNR ROULEMENTS is strictly prohibited. Legal action may be brought against anyone breaching the terms of this paragraph. NTN-SNR ROULEMENTS shall not be held liable for any errors or omissions that may have crept into this document despite the care taken in drafting it. Due to our policy of continuous research and development, we reserve the right to make changes without notice to all or part of the products and specifications mentioned in this document. © NTN-SNR ROULEMENTS, international copyright 2021.



**DYNAMIC WHEEL & CASTOR SOLUTIONS**

T 01457 837772  
E sales@aut.co.uk  
W www.aut.co.uk

AUT (Wheels and Castors) Ltd are a national castor company that have supplied quality wheels and castors for over 40 years.

All our castors are tested to all relevant European norms so you can be confident on quality and conformity.

The following is a standard range of castors. We have many other options available upon request. Our Series 64 range shows some of our heavier duty castors for your reference.

Our **Utility Range** has been designed specifically to cater for as much as 90% of the everyday applications of wheels and castors:



**Versatile**

Can be used across a broad spectrum of industries and applications



**Cost effective**

Exceptionally cost effective range of wheels and castors



**Designed with style in mind**

To complement your finished products



**Broad range of carrying capacities**

Meaning you can be confident we can meet any weight specific requirements



**Available in stainless steel**

Making it perfect for hygienic or clean areas



**Market-leading innovation**

Products like the durable Series 62ER towing castors, heavy duty Series 62NY and hybrid wheel 62SH

CASTORS

**SERIES AT** Grey TPR tyred apparatus wheels and castors



85 Shore A



50 - 150mm



50 - 100kg



Plain Bore



Ball Bearing

- > **Polypropylene** light grey wheel centre with thermoplastic rubber dark grey tread
- > **Plain bearing** without threadguards. **Single ball bearing** has plastic threadguards.

- > **Pressed steel**, zinc plated castor body
- > **Ideal** for use in manual handling, medical centres and the hotel industry

**APPARATUS CASTORS**



									SWIVEL	FIXED	TOTAL & BRAKE	BOLT HOLE	BOLT HOLE & TOTAL BRAKE
	50	19	70	60x60	48/39x48/39	6.3	11	50	AT050P2Z21	AT050P3Z21	AT050P4Z21	AT050P5Z21	AT050P6Z21
	50	19	70	60x60	48/39x48/39	6.3	11	50	AT050B2Z21	AT050B3Z21	AT050B4Z21	AT050B5Z21	AT050B6Z21



Aluminium Pedal



## TOP PLATE CASTORS

									SWIVEL	FIXED	TOTAL & BRAKE	
	75	25	100	60x60	48/38x48/38		6.3	11	75	AT075P2Z21	AT075P3Z21	AT075P4Z21
	100	32	135	77x67	61.5/56x51.5/46.5		8.5	11	100	AT100P2Z21	AT100P3Z21	AT100P4Z21
	125	32	160	77x67	61.5/56x51.5/46.5		8.5	11	100	AT125P2Z21	AT125P3Z21	AT125P4Z21
	125	32	160	95x70	75x50		11	-	100	AT125P2Z31	AT125P3Z31	AT125P4Z31
	150	32	185	77x67	61.5/56x51.5/46.5		8.5	11	100	AT150P2Z21	AT150P3Z21	AT150P4Z21
	75	25	100	60x60	48/38x48/38		6.3	11	75	AT075B2Z21	AT075B3Z21	AT075B4Z21
	100	32	135	77x67	61.5/56x51.5/46.5		8.5	11	100	AT100B2Z21	AT100B3Z21	AT100B4Z21
	125	32	160	77x67	61.5/56x51.5/46.5		8.5	11	100	AT125B2Z21	AT125B3Z21	AT125B4Z21
	125	32	160	95x70	75x50		11	-	100	AT125B2Z31	AT125B3Z31	AT125B4Z31
	150	32	185	77x67	61.5/56x51.5/46.5		8.5	11	100	AT150B2Z21	AT150B3Z21	AT150B4Z21

Aluminium Pedal



## BOLT HOLE CASTORS

						SWIVEL	TOTAL & BRAKE
	75	25	100	11	75	AT075P5Z21	AT075P6Z21
	100	32	135	11	100	AT100P5Z21	AT100P6Z21
	125	32	160	11	100	AT125P5Z31	AT125P6Z31
	150	32	185	11	100	AT150P5Z21	AT150P6Z21
	75	25	100	11	75	AT075B5Z21	AT075B6Z21
	100	32	135	11	100	AT100B5Z21	AT100B6Z21
	125	32	160	11	100	AT125B5Z31	AT125B6Z31
	150	32	185	11	100	AT150B5Z21	AT150B6Z21

CASTORS

## TWIN WHEEL CASTORS TOP PLATE & BOLT HOLE



									SWIVEL	SWIVEL & BRAKE	BOLT HOLE	BOLT HOLE & BRAKE	
	50	19	70	60x60	48/39x48/39		6.3	11	25	AT050P2Z81	AT050P4Z81	AT050P5Z81	AT050P6Z81
	75	25	102	77x67	61.5/56x51.5/46.6		8.5	11	31.4	AT075P2Z81	AT075P4Z81	AT075P5Z81	AT075P6Z81
	50	19	70	60x60	48/39x48/39		6.3	11	25	AT050B2Z81	AT050B4Z81	AT050B5Z81	AT050B6Z81
	75	25	102	77x67	61.5/56x51.5/46.6		8.5	11	31.4	AT075B2Z81	AT075B4Z81	AT075B5Z81	AT075B6Z81



## SERIES B

Grey non-marking rubber tyre on black plastic centre wheels and castors



80 - 200mm



70 - 250kg









Roller Bearing

- > **Polypropylene** black wheel centre with grey solid rubber wheel
- > **Without** threadguards

- > **Pressed steel**, zinc plated castor body
- > **Ideal** for handling trolleys









### WHEEL

 (mm)	 (mm)	 (mm)	 (mm)	 (daN)	 (code)
80	35	12	40	70	<b>B080R1021</b>
100	35	12	40	75	<b>B100R1021</b>
125	38	15	50	100	<b>B125R1021</b>
160	40	20	59	135	<b>B160R1021</b>
200	50	20	59	205	<b>B200R1021</b>

### TOP PLATE & BOLT HOLE CASTORS



 (mm)	 (mm)	 (mm)	 (mm)	 (mm)	 (mm)	 (kg)	SWIVEL	FIXED	+ TOTAL BRAKE	BOLT HOLE	+ TOTAL BRAKE	
80	35	105	105x80	80/77x60	9	13	70	<b>B080R2Z21</b>	<b>B080R3Z21</b>	<b>B080R4Z21</b>	<b>B080R5Z21</b>	<b>B080R6Z21</b>
100	35	125	105x80	80/77x60	9	13	75	<b>B100R2Z21</b>	<b>B100R3Z21</b>	<b>B100R4Z21</b>	<b>B100R5Z21</b>	<b>B100R6Z21</b>
125	38	155	105x80	80/77x60	9	13	100	<b>B125R2Z21</b>	<b>B125R3Z21</b>	<b>B125R4Z21</b>	<b>B125R5Z21</b>	<b>B125R6Z21</b>
160	40	195	135x110	105x84/76	11	13	135	<b>B160R2Z21</b>	<b>B160R3Z21</b>	<b>B160R4Z21</b>	<b>B160R5Z21</b>	<b>B160R6Z21</b>
200	50	235	135x110	105x84/76	11	13	205	<b>B200R2Z21</b>	<b>B200R3Z21</b>	<b>B200R4Z21</b>	<b>B200R5Z21</b>	<b>B200R6Z21</b>

## SERIES C

Black rubber tyre on black plastic centre wheels and castors



80 - 200mm



70 - 205kg









Roller Bearing

- > **Black polypropylene** wheel centre with black solid rubber tread
- > **Without** threadguards

- > **Pressed steel**, zinc plated castor body
- > **Ideal** for handling trolleys









### WHEEL

 (mm)	 (mm)	 (mm)	 (mm)	 (daN)	 (code)
80	35	12	40	70	<b>C080R1021</b>
100	35	12	40	75	<b>C100R1021</b>
125	38	15	50	100	<b>C125R1021</b>
160	40	20	59	135	<b>C160R1021</b>
200	50	20	59	205	<b>C200R1021</b>

### TOP PLATE & BOLT HOLE CASTORS



 (mm)	 (mm)	 (mm)	 (mm)	 (mm)	 (mm)	 (kg)	SWIVEL	FIXED	+ TOTAL BRAKE	BOLT HOLE	+ TOTAL BRAKE	
80	35	105	105x80	80/77x60	9	13	70	<b>C080R2Z21</b>	<b>C080R3Z21</b>	<b>C080R4Z21</b>	<b>C080R5Z21</b>	<b>C080R6Z21</b>
100	35	125	105x80	80/77x60	9	13	75	<b>C100R2Z21</b>	<b>C100R3Z21</b>	<b>C100R4Z21</b>	<b>C100R5Z21</b>	<b>C100R6Z21</b>
125	38	155	105x80	80/77x60	9	13	100	<b>C125R2Z21</b>	<b>C125R3Z21</b>	<b>C125R4Z21</b>	<b>C125R5Z21</b>	<b>C125R6Z21</b>
160	40	195	135x110	105x84/76	11	13	135	<b>C160R2Z21</b>	<b>C160R3Z21</b>	<b>C160R4Z21</b>	<b>C160R5Z21</b>	<b>C160R6Z21</b>
200	50	235	135x110	105x84/76	11	13	205	<b>C200R2Z21</b>	<b>C200R3Z21</b>	<b>C200R4Z21</b>	<b>C200R5Z21</b>	<b>C200R6Z21</b>



## SERIES D

Black rubber tyre on steel centre wheels and castors



80 - 200mm



70 - 205kg









Roller Bearing

- > **Steel centre** wheel with black solid rubber tread
- > **Without** threadguards

- > **Pressed steel**, zinc plated castor body
- > **Ideal** for handling trolleys









### WHEEL

 (mm)	 (mm)	 (mm)	 (mm)	 (daN)	 (code)
80	35	12	40	70	D080R1021
100	35	12	40	75	D100R1021
125	38	15	40	100	D125R1021
160	40	20	50	135	D160R1021
200	50	20	50	205	D200R1021

### TOP PLATE & BOLT HOLE CASTORS



 (mm)	 (mm)	 (mm)	 (mm)	 (mm)	 (mm)	 (kg)	SWIVEL	FIXED	+ TOTAL BRAKE	BOLT HOLE	+ TOTAL BRAKE	
80	27	105	105x80	80/77x60	9	13	70	D080R2Z21	D080R3Z21	D080R4Z21	D080R5Z21	D080R6Z21
100	27	128	105x80	80/77x60	9	13	75	D100R2Z21	D100R3Z21	D100R4Z21	D100R5Z21	D100R6Z21
125	38	155	105x80	80/77x60	9	13	100	D125R2Z21	D125R3Z21	D125R4Z21	D125R5Z21	D125R6Z21
160	40	195	135x110	105x84/76	11	13	135	D160R2Z21	D160R3Z21	D160R4Z21	D160R5Z21	D160R6Z21
200	50	235	135x110	105x84/76	11	13	205	D200R2Z21	D200R3Z21	D200R4Z21	D200R5Z21	D200R6Z21

CASTORS

## SERIES D

Black rubber tyre on pressed steel centre wheels in refuse castor



200mm



205kg



Roller Bearing



- > **Steel centre** wheel with black solid rubber tread

- > **Pressed steel**, zinc plated castor body

- > **Without** threadguards











### WHEEL

 (mm)	 (mm)	 (mm)	 (mm)	 (daN)	 (code)
200	50	20	60	205	D200R1071

### TOP PLATE & BOLT HOLE CASTORS



 (mm)	 (mm)	 (mm)	 (mm)	 (mm)	 (mm)	 (mm)	 (kg)	SWIVEL	+ BACK BRAKE	+ BACK BRAKE & SCREW
200	50	235	135x110	105x84/76	11	55	205	D200R2Z71	D200R4Z71	D200R4Z81



## SERIES DG Grey rubber tyre on steel centre wheels and castors



- > **Steel centre** wheel with grey solid rubber tread
- > **Without** threadguards
- > **Pressed steel**, zinc plated castor body
- > **Ideal** for handling trolleys



### TOP PLATE & BOLT HOLE CASTORS

							SWIVEL	FIXED	+ TOTAL BRAKE	BOLT HOLE	+ TOTAL BRAKE		
	80	27	105	105x80	80/77x60	9	13	70	DG080R2Z21	DG080R3Z21	DG080R4Z21	DG080R5Z21	DG080R6Z21
	100	27	125	105x80	80/77x60	9	13	75	DG100R2Z21	DG100R3Z21	DG100R4Z21	DG100R5Z21	DG100R6Z21
	125	38	155	105x80	80/77x60	9	13	100	DG125R2Z21	DG125R3Z21	DG125R4Z21	DG125R5Z21	DG125R6Z21
	160	40	195	135x110	105x84/76	11	13	135	DG160R2Z21	DG160R3Z21	DG160R4Z21	DG160R5Z21	DG160R6Z21
	200	50	235	135x110	105x84/76	11	13	205	DG200R2Z21	DG200R3Z21	DG200R4Z21	DG200R5Z21	DG200R6Z21

## SERIES E Injection moulded polyurethane tyre bonded to nylon centre wheel & castors



- > **Red polyurethane tyre** on grey polyamide centre wheel
- > **Roller bearing** has metal threadguards. **Ball bearing** has plastic threadguards.
- > **Pressed steel**, zinc plated castor body
- > **Ideal** for handling trolleys



### WHEELS

					(code)	(code)
(mm)	(mm)	(mm)	(mm)	(daN)		
80	30	12	39	120	E080R1021	-
80	30	8	40	100	-	E080B1021
100	32	12	40	150	E100R1021	-
100	32	15	40	150	-	E100B1021
125	32	15	50	200	E125R1021	E125B1021
160	40	20	59	300	E160R1055	E160B1055
200	50	20	59	350	E200R1055	E200B1055

### TOP PLATE CASTORS



							SWIVEL	FIXED	+ TOTAL BRAKE	
	80	30	108	105x80	80/77x60	9	120	E080R2Z21	E080R3Z21	E080R4Z21
	100	32	125	105x80	80/77x60	9	150	E100R2Z21	E100R3Z21	E100R4Z21
	125	32	155	105x80	80/77x60	9	200	E125R2Z21	E125R3Z21	E125R4Z21
	160	40	195	135x110	105x84/76	11	300	E160R2Z21	E160R3Z21	E160R4Z21
	200	50	235	135x110	105x84/76	11	350	E200R2Z21	E200R3Z21	E200R4Z21
	80	30	108	105x80	80/77x60	9	120	E080B2Z21	E080B3Z21	E080B4Z21
	100	32	125	105x80	80/77x60	9	150	E100B2Z21	E100B3Z21	E100B4Z21
	125	32	155	105x80	80/77x60	9	200	E125B2Z21	E125B3Z21	E125B4Z21
	160	40	195	135x110	105x84/76	11	300	E160B2Z21	E160B3Z21	E160B4Z21
	200	50	235	135x110	105x84/76	11	350	E200B2Z21	E200B3Z21	E200B4Z21

Bolt Hole castors available on request



## SERIES F

Natural polyamide wheels and standard castors



80 - 200mm



130 - 300kg



Plain Bore



Roller Bearing

- > Natural polyamide wheel
- > Plain bearing without threadguards. Roller bearing has metal threadguards

- > Pressed steel, zinc plated castor body
- > Ideal for handling trolleys



## WHEELS

(mm)	(mm)	(mm)	(mm)	(daN)	(code)	(code)
80	34	12	40	130	F080P1021	F080R1021
100	36	12	40	150	F100P1021	F100R1021
125	38	15	50	200	F125P1021	F125R1021
160	40	20	59	300	-	F160R1021
200	50	20	59	300	-	F200R1021

Plain bore larger sizes available on request



## TOP PLATE CASTORS

		(mm)	(mm)	(mm)	(mm)	(mm)	(mm)	(daN)	SWIVEL	FIXED	+ TOTAL BRAKE
	80	34	105	105x80	87/77x60	9	130	130	F080P2Z21	F080P3Z21	F080P4Z21
	100	36	125	105x80	87/77x60	9	150	150	F100P2Z21	F100P3Z21	F100P4Z21
	125	38	155	105x80	87/77x60	9	200	200	F125P2Z21	F125P3Z21	F125P4Z21
	160	40	195	135x110	105x84/76	11	300	-	-	-	-
	200	50	235	135x110	105x84/76	11	300	-	-	-	-
	80	34	105	105x80	87/77x60	9	130	130	F080R2Z21	F080R3Z21	F080R4Z21
	100	36	125	105x80	87/77x60	9	150	150	F100R2Z21	F100R3Z21	F100R4Z21
	125	38	155	105x80	87/77x60	9	200	200	F125R2Z21	F125R3Z21	F125R4Z21
	125	38	155	135x110	105x84/76	11	250	250	F125R2Z25	F125R3Z25	F125R4Z25
	160	40	195	135x110	105x84/76	11	300	300	F160R2Z21	F160R3Z21	F160R4Z21
	200	50	235	135x110	105x84/76	11	300	300	F200R2Z21	F200R3Z21	F200R4Z21

## BOLT HOLE CASTORS

		(mm)	(mm)	(mm)	(mm)	(mm)	(mm)	(daN)	SWIVEL	+ TOTAL BRAKE
	80	34	105	105	13	130	130	130	F080P5Z21	F080P6Z21
	100	36	125	125	13	150	150	150	F100P5Z21	F100P6Z21
	125	38	155	155	13	150	150	150	F125P5Z21	F125P6Z21
	160	40	195	195	13	200	-	-	-	-
	200	50	235	235	13	200	-	-	-	-
	80	34	105	105	13	130	130	130	F080R5Z21	F080R6Z21
	100	36	125	125	13	150	150	150	F100R5Z21	F100R6Z21
	125	38	155	155	13	150	150	150	F125R5Z21	F125R6Z21
	160	40	195	195	13	200	200	200	F160R5Z21	F160R6Z21
	200	50	235	235	13	200	200	200	F200R5Z21	F200R6Z21





## SERIES G

White polypropylene wheels and castors



80 - 200mm



80 - 250kg



Plain Bore



Roller Bearing

- > White polypropylene wheel
- > Plain bearing without threadguards. **Roller bearing** has metal threadguards
- > Pressed steel, zinc plated castor body
- > Ideal for handling trolleys



## WHEELS

(mm)	(mm)	(mm)	(mm)	(daN)	(code)	(code)
80	34	12	40	80	G080P1021	G080R1021
100	36	12	40	100	G100P1021	G100R1021
125	38	15	50	150	G125P1021	G125R1021
160	40	20	59	250	-	G160R1021
200	50	20	59	250	-	G200R1021

Plain bore larger sizes available on request



## TOP PLATE CASTORS

	(mm)	(mm)	(mm)	(mm)	(mm)	(mm)	(daN)	SWIVEL	FIXED	+ TOTAL BRAKE
	80	34	105	105x80	87/77x60	9	80	G080P2Z21	G080P3Z21	G080P4Z21
	100	36	125	105x80	87/77x60	9	100	G100P2Z21	G100P3Z21	G100P4Z21
	125	38	155	105x80	87/77x60	9	150	G125P2Z21	G125P3Z21	G125P4Z21
	160	40	195	135x110	105x84/76	11	200	-	-	-
	200	50	235	135x110	105x84/76	11	250	-	-	-
	80	34	105	105x80	87/77x60	9	80	G080R2Z21	G080R3Z21	G080R4Z21
	100	36	125	105x80	87/77x60	9	100	G100R2Z21	G100R3Z21	G100R4Z21
	125	38	155	105x80	87/77x60	9	150	G125R2Z21	G125R3Z21	G125R4Z21
	125	38	155	135x110	105x84/76	11	200	G125R2Z25	G125R3Z25	G125R4Z25
	160	40	195	135x110	105x84/76	11	200	G160R2Z21	G160R3Z21	G160R4Z21
	200	50	235	135x110	105x84/76	11	250	G200R2Z21	G200R3Z21	G200R4Z21



## BOLT HOLE CASTORS

	(mm)	(mm)	(mm)	(mm)	(mm)	(daN)	SWIVEL	+ TOTAL BRAKE
	80	34	104	13	70	70	G080P5Z21	G080P6Z21
	100	36	124	13	90	90	G100P5Z21	G100P6Z21
	125	38	154	13	140	140	G125P5Z21	G125P6Z21
	160	40	194	13	200	200	-	-
	200	50	234	13	200	200	-	-
	80	34	104	13	70	70	G080R5Z21	G080R6Z21
	100	36	124	13	90	90	G100R5Z21	G100R6Z21
	125	38	154	13	140	140	G125R5Z21	G125R6Z21
	160	40	194	13	200	200	G160R5Z21	G160R6Z21
	200	50	234	13	200	200	G200R5Z21	G200R6Z21



## SERIES H

Blue elastic tyre bonded to nylon wheel centre and castors



65 Shore A



80 - 200mm



130 - 250kg



Roller Bearing



Ball Bearing

- > Black polyamide wheel with blue elastic rubber tread
- > Roller bearing without threadguards. Ball bearing has plastic threadguards

- > Pressed steel, zinc plated castor body
- > Ideal for handling trolleys



## WHEELS

(mm)	(mm)	(mm)	(mm)	(daN)	(code)	(code)
80	35	12	40	130	H080R1021	H080B1021
100	35	12	40	150	H100R1021	H100B1021
125	38	15	50	150	H125R1021	H125B1021
160	46	20	59	200	H160R1021	-
200	46	20	59	250	H200R1021	-

## TOP PLATE CASTORS



								SWIVEL	FIXED	+ TOTAL BRAKE
	80	35	105	105x80	87/77x60	9	130	H080R2Z21	H080R3Z21	H080R4Z21
	100	35	125	105x80	87/77x60	9	150	H100R2Z21	H100R3Z21	H100R4Z21
	125	38	155	105x80	87/77x60	9	150	H125R2Z21	H125R3Z21	H125R4Z21
	160	46	195	135x110	105x84/76	11	200	H160R2Z21	H160R3Z21	H160R4Z21
	200	46	235	135x110	105x84/76	11	250	H200R2Z21	H200R3Z21	H200R4Z21

								SWIVEL	FIXED	+ TOTAL BRAKE
	80	35	105	105x80	87/77x60	9	130	H080B2Z21	H080B3Z21	H080B4Z21
	100	35	125	105x80	87/77x60	9	150	H100B2Z21	H100B3Z21	H100B4Z21
	125	38	155	105x80	87/77x60	9	150	H125B2Z21	H125B3Z21	H125B4Z21
	160	46	195	135x110	105x84/76	11	200	H160B2Z21	H160B3Z21	H160B4Z21
	200	46	235	135x110	105x84/76	11	250	H200B2Z21	H200B3Z21	H200B4Z21

## BOLT HOLE CASTORS



								SWIVEL	+ TOTAL BRAKE
	80	35	104	13	130	H080R5Z21	H080R6Z21		
	100	35	124	13	150	H100R5Z21	H100R6Z21		
	125	38	154	13	150	H125R5Z21	H125R6Z21		
	160	46	194	13	200	H160R5Z21	H160R6Z21		
	200	46	234	13	250	H200R5Z21	H200R6Z21		

								SWIVEL	+ TOTAL BRAKE
	80	35	104	13	130	H080B5Z21	H080B6Z21		
	100	35	124	13	150	H100B5Z21	H100B6Z21		
	125	38	154	13	150	H125B5Z21	H125B6Z21		
	160	46	194	13	200	H160B5Z21	H160B6Z21		
	200	46	234	13	250	H200B5Z21	H200B6Z21		



## SERIES K Thermoplastic rubber tyred wheels with polypropylene centre and standard castors



65 Shore A



80 - 200mm



70 - 205kg



Roller Bearing



Ball Bearing

- > **Light grey** polypropylene wheel with dark grey thermoplastic rubber tread
- > **Roller bearing** has metal threadguards. **Ball bearing** has plastic threadguards

- > **Pressed steel**, zinc plated castor body
- > **Ideal** for handling trolleys



### WHEELS

(mm)	(mm)	(mm)	(mm)	(daN)	(code)	(code)
80	30	12	39	70	K080R1021	-
80	30	8	40	70	-	K080B1021
100	32	12	40	100	K100R1021	-
100	32	15	40	100	-	K100B1021
125	32	15	50	135	K125R1021	K125B1021
160	40	20	59	200	K160R1021	K160B1021
200	50	20	59	205	K200R1021	K200B1021



### TOP PLATE CASTORS

								SWIVEL	FIXED	+ TOTAL BRAKE
	80	30	108	105x80	80/77x60	9	70	K080R2Z21	K080R3Z21	K080R4Z21
	100	32	125	105x80	80/77x60	9	100	K100R2Z21	K100R3Z21	K100R4Z21
	125	32	155	105x80	80/77x60	9	135	K125R2Z21	K125R3Z21	K125R4Z21
	160	40	195	135x110	105x84/76	11	200	K160R2Z21	K160R3Z21	K160R4Z21
	200	50	235	135x110	105x84/76	11	205	K200R2Z21	K200R3Z21	K200R4Z21
	80	30	108	105x80	80/77x60	9	70	K080B2Z21	K080B3Z21	K080B4Z21
	100	32	125	105x80	80/77x60	9	100	K100B2Z21	K100B3Z21	K100B4Z21
	125	32	155	105x80	80/77x60	9	135	K125B2Z21	K125B3Z21	K125B4Z21
	160	40	195	135x110	105x84/76	11	200	K160B2Z21	K160B3Z21	K160B4Z21
	200	50	235	135x110	105x84/76	11	205	K200B2Z21	K200B3Z21	K200B4Z21

Bolt Hole Castors available on request

CASTORS



## SERIES ST Stainless Steel Castors



Plain Bore

- > Standard duty loads
- > Pressed stainless steel castor housing
- > Suitable for use on compact floors



Copolymer

80 - 100mm



0°C to +60°C



80 - 125kg

Nylon

125 - 200mm

-20°C to +80°C

130 - 180kg

### STAINLESS STEEL STANDARD DUTY CASTORS



									SWIVEL	FIXED	SWIVEL & BRAKE	BOLT HOLE	BOLT HOLE & BRAKE
80	30	108	100x80	80x60	9	12	80	F080P2S01	F080P3S01	F080P4S01	F080P5S01	F080P6S01	
100	30	127	100x80	80x60	9	12	125	F100P2S01	F100P3S01	F100P4S01	F100P5S01	F100P6S01	
125	35	155	100x80	80x60	9	12	130	F125P2S01	F125P3S01	F125P4S01	F125P5S01	F125P6S01	
150	45	192	129x106	105x80	11	16	180	F150P2S01	F150P3S01	F150P4S01	F150P5S01	F150P6S01	
200	55	240	129x106	105x80	11	16	180	F200P2S01	F200P3S01	F200P4S01	F200P5S01	F200P6S01	

- > Grey non-marking thermoplastic
- > Standard duty loads
- > Pressed steel and stainless steel castor housings
- > Excellent rolling resistance



80 - 200mm



-20°C to +70°C



70 - 200kg

CASTORS

### STAINLESS STEEL STANDARD DUTY CASTORS



									SWIVEL	FIXED	SWIVEL & BRAKE	BOLT HOLE	BOLT HOLE & BRAKE
80	30	108	100x80	80x60	9	12	70	K080P2S01	K080P3S01	K080P4S01	K080P5S01	K080P6S01	
100	30	127	100x80	80x60	9	12	100	K100P2S01	K100P3S01	K100P4S01	K100P5S01	K100P6S01	
125	35	155	100x80	80x60	9	12	120	K125P2S01	K125P3S01	K125P4S01	K125P5S01	K125P6S01	
150	45	192	129x106	105x80	11	16	180	K150P2S01	K150P3S01	K150P4S01	K150P5S01	K150P6S01	
200	55	240	129x106	105x80	11	16	200	K200P2S01	K200P3S01	K200P4S01	K200P5S01	K200P6S01	



## SERIES ST Stainless Steel Castors



Plain Bore

- > Polyurethane on polyamide centre
- > Standard duty loads
- > Pressed steel and stainless steel castor housings
- > Suitable for food processing and chemical industry



65 Shore D



80 - 200mm



-15°C to +80°C



120 - 200kg

### STAINLESS STEEL STANDARD DUTY CASTORS



									SWIVEL	FIXED	SWIVEL & BRAKE
	80	30	108	100x80	80x60	9	12	120	E080P2S01	E080P3S01	E080P4S01
	100	30	127	100x80	80x60	9	12	130	E100P2S01	E100P3S01	E100P4S01
	125	35	155	100x80	80x60	9	12	130	E125P2S01	E125P3S01	E125P4S01
	150	45	192	129x106	105x80	11	16	200	E150P2S01	E150P3S01	E150P4S01
	200	55	240	129x106	105x80	11	16	200	E200P2S01	E200P3S01	E200P4S01

Bolt Hole Castors available on request

- > Blue non-marking elastic rubber
- > Standard duty loads
- > Pressed steel and stainless steel castor housings
- > Suitable for use on compact floors



73 Shore A



100 - 200mm



-20°C to +70°C



130 - 200kg

### STAINLESS STEEL STANDARD DUTY CASTORS



									SWIVEL	FIXED	SWIVEL & BRAKE	BOLT HOLE	BOLT HOLE & BRAKE
	100	30	127	100x80	80x60	9	12	130	H100P2S01	H100P3S01	H100P4S01	H100P5S01	H100P6S01
	125	35	155	100x80	80x60	9	12	130	H125P2S01	H125P3S01	H125P4S01	H125P5S01	H125P6S01
	160	45	197	129x106	105x80	11	16	200	H160P2S01	H160P3S01	H160P4S01	H160P5S01	H160P6S01
	200	55	240	129x106	105x80	11	16	200	H200P2S01	H200P3S01	H200P4S01	H200P5S01	H200P6S01

- > Grey non-marking elastic rubber
- > Standard duty loads
- > Pressed steel and stainless steel castor housings
- > Suitable for use on compact floors



80 - 200mm



-20°C to +60°C



70 - 200kg

### STAINLESS STEEL STANDARD DUTY CASTORS



									SWIVEL	FIXED	SWIVEL & BRAKE	BOLT HOLE	BOLT HOLE & BRAKE
	100	30	127	100x80	80x60	9	12	70	B100P2S01	B100P3S01	B100P4S01	B100P5S01	B100P6S01
	125	35	155	100x80	80x60	9	12	100	B125P2S01	B125P3S01	B125P4S01	B125P5S01	B125P6S01
	160	45	197	129x106	105x80	11	16	150	B160P2S01	B160P3S01	B160P4S01	B160P5S01	B160P6S01
	200	55	240	129x106	105x80	11	16	200	B200P2S01	B200P3S01	B200P4S01	B200P5S01	B200P6S01



## SERIES T

Cast polyurethane tyre bonded to cast aluminium wheel centres and castors



100 - 200mm



250 - 400kg









Ball Bearing

- > **Aluminium centre** wheel with brown polyurethane tread
- > **Without** threadguards

- > **Pressed steel**, zinc plated castor body
- > **Ideal** for handling trolleys and pallet trucks









### WHEELS

					
(mm)	(mm)	(mm)	(mm)	(daN)	(code)
100	40	12	40	250	T100B1051
125	40	15	40	300	T125B1051

### TOP PLATE CASTORS



							SWIVEL	FIXED	+ TOTAL BRAKE
100	40	128	105x80	80/77x60	9	250	T100B2Z51	T100B3Z51	T100B4Z51
100	40	128	135x110	105x84/76	11	250	T100B2Z52	T100B3Z52	T100B4Z52
125	40	155	105x80	80/77x60	9	300	T125B2Z51	T125B3Z51	T125B4Z51
125	40	155	135x110	105x84/76	11	300	T125B2Z52	T125B3Z52	T125B4Z52

## SERIES V

Black elastic rubber tyre bonded to aluminium wheel centres & castors



125 - 200mm



250 - 400kg









Ball Bearing

- > **Aluminium centre** wheel with black elastic rubber tread
- > **Without** threadguards

- > **Pressed steel**, zinc plated castor body
- > **Ideal** for pallet trucks









### WHEELS

					
(mm)	(mm)	(mm)	(mm)	(daN)	(code)
125	40	15	50	250	V125B1051
160	40	15	60	300	V160B1051
200	40	20	60	400	V200B1051

### TOP PLATE CASTORS



							SWIVEL	FIXED	+ TOTAL BRAKE
125	40	162	135x110	105x84/76	11	250	V125B2Z51	V125B3Z51	V125B4Z51
160	40	195	135x110	105x84/76	11	300	V160B2Z51	V160B3Z51	V160B4Z51
200	50	235	135x110	105x84/76	11	400	V200B2Z51	V200B3Z51	V200B4Z51

CASTORS



## SERIES 64 Cast polyurethane tyre bonded to cast iron centre wheel



- > Cast iron centre wheel
- > Zinc plated pressed steel castor housings
- > Standard to medium-heavy duty loads
- > Ideal for applications with heavy duty loads

### WHEELS



(mm)	(mm)	(mm)	(mm)	(mm)	(mm)	(daN)	(daN)	(daN)	(kg)	(code)
80	20	12	18	32	14	200	150	150	0.45	642181
100	38	15	40	35	11	500	220	380	1.02	642152
125	38	15	40	47	15	600	240	450	1.45	642153
150	50	20	55	47	15	910	290	700	2.50	642154
160	50	20	55	47	14	1000	300	750	2.65	642164
180	50	20	55	47	14	1100	350	9000	3.02	642155
200	50	20	55	47	14	1500	380	1000	3.65	642156
250	60	25	65	62	17	2500	480	1500	8.13	642157
300	60	30	65	62	17	3200	550	1750	11.43	642158
360	120	40	120	90	23	3800	750	2800	31.63	642139
400	100	50	120	110	28	4500	750	2800	28.86	642126

More sizes and bore types (including plain bore) available on request

CASTORS

### STANDARD DUTY CASTORS - NL



										SWIVEL	FIXED	SWIVEL & BRAKE		
80	28	107	100x85	80x60	9	37	120	220	0.95	644551	0.82	644651	1.11	645451
100	38	128	100x85	80x60	9	35	120	220	1.51	644552	1.40	644652	1.67	645452
125	38	156	100x85	80x60	9	37	120	220	1.97	644553	1.86	644653	2.13	645453
125	50	165	140x110	105x80	11	56	156	300	3.38	644563	2.89	644663	3.58	645463
150	50	194	140x110	105x80	11	56	156	300	3.87	644554	3.59	644654	4.12	645464
160	50	199	140x110	105x80	11	56	156	300	3.98	644564	3.71	644664	4.23	645474
180	50	220	140x110	105x80	11	56	156	300	4.48	644555	4.21	644655	4.68	645465
200	50	240	140x110	105x80	11	56	156	300	5.16	644556	4.92	644656	5.36	645466

### HEAVY DUTY CASTORS - P



										SWIVEL	FIXED	SWIVEL & BRAKE	SWIVEL & BRAKE		
80	28	128	100x85	80x60	9	50	-	280	1.38	645851	0.96	646851	-	-	
100	38	138	100x85	80x60	9	46	123	350	1.93	645852	1.52	646852	2.06	644852	
125	38	161	100x85	80x60	9	48	123	350	2.37	645853	2.04	646853	2.50	644853	
125	50	170	140x110	105x80	11	70	126	550	3.66	645863	2.65	646863	-	4.24	644863
150	50	200	140x110	105x80	11	70	126	700	4.81	645854	3.55	646854	-	5.33	644854
160	50	205	140x110	105x80	11	70	126	750	4.93	645864	4.93	646864	-	5.45	644864
180	50	228	140x110	105x80	11	70	126	750	5.30	645855	4.45	646855	-	5.90	644855
200	50	250	140x110	105x80	11	70	126	750	6.06	645856	5.15	646856	-	6.66	644856

More castor types (including medium duty and twin wheel) available on request



## SERIES 67HS

Heat resistant wheels and castors



80 Shore A -20°C to +500°C 80 - 200mm



75 - 700kg









Plain Bore

- > Heat resistant wheels produced from a variety of materials
- > Plain, glacier and ball bearing bore wheels

- > Heat stable wheels are heat resistant, synthetic material
- > Ideal for the food processing industry











## WHEELS

 (mm)	 (mm)	 (mm)	 (mm)	 (daN)	 (code)
80	33	12	40	100	67HS1011
100	34	12	40	180	67HS1032
100	34	12	40	250	67HS1012
100	34	12	40	250	67HS1012/G*
100	40	15	47	250	67HS1022
125	38	15	44	300	67HS1013
150	52	20	58	350	67HS1014
200	52	20	58	400	67HS1016

\*67HS1012/G comes with glacier bush

## STANDARD DUTY CASTORS - NL











								SWIVEL	FIXED	BOLT HOLE
100	34	128	102x84	80x60	12	150	67HS4402	67HS5702	67HS6662	

CASTORS

## STAINLESS STEEL STANDARD DUTY CASTORS - NLX



								SWIVEL	FIXED	BOLT HOLE
100	34	128	102x84	80x60	12	150	67HS4412	67HS5712	67HS6612	





## SERIES KS Soft grey thermoplastic wheels and castors









65 Shore A -20°C to +80°C 100 - 250mm 135 - 300kg Ball Bearing

- > **Soft grey thermoplastic** rubber tyre, bonded to polypropylene centre
- > **Excellent rolling resistance** and quiet running
- > **Suitable for humid environments** with medium harsh chemicals
- > **Ideal** for trolleys with light duty loads







## WHEELS



 (mm)	 (mm)	 (mm)	 (mm)	 (daN)	 (code)
100	8	40	36	135	KS100B1021
125	10	50	36	165	KS125B1021
160	12	59	40	200	KS160B1021
200	12	59	40	250	KS200B1021
250	12	59	40	300	KS250B1021







## TOP PLATE CASTORS



						 (daN)	SWIVEL	FIXED	SWIVEL & BRAKE
100	36	125	80x60	9	40	135	KS100B2Z21	KS100B3Z21	KS100B4Z21
125	36	155	80x60	9	40	165	KS125B2Z21	KS125B3Z21	KS125B4Z21
160	40	195	105x80	11	55	200	KS160B2Z21	KS160B3Z21	KS160B4Z21
200	40	235	105x80	11	55	250	KS200B2Z21	KS200B3Z21	KS200B4Z21
250	40	295	105x80	11	65	300	KS250B2Z21	KS250B3Z21	KS250B4Z21

## BOLT HOLE CASTORS



					 (kg)	BOLT HOLE	BOLT HOLE & BRAKE
100	36	124	40	13	135	KS100B5Z21	KS100B6Z21
125	36	154	40	13	165	KS125B5Z21	KS125B6Z21
160	40	189	55	13	200	KS160B5Z21	KS160B6Z21
200	40	228	55	13	250	KS200B5Z21	KS200B6Z21



## SERIES KSA/E Soft conductive thermoplastic wheels and castors









65 Shore A -20°C to +80°C 100 - 200mm 90 - 175kg Ball Bearing

- > **Soft conductive thermoplastic** rubber tyre, bonded to polypropylene centre
- > **Excellent rolling resistance** and quiet running
- > **Suitable for humid environments** with medium harsh chemicals
- > **Ideal** for trolleys with light duty loads









### WHEELS

 (mm)	 (mm)	 (mm)	 (mm)	 (daN)	 (code)
100	8	40	36	90	KSA100B1021A
100	8	40	36	90	KSA100B1021E
125	10	50	36	120	KSA125B1021A
125	10	50	36	120	KSA125B1021E
160	12	59	40	135	KSA160B1021A
160	12	59	40	135	KSA160B1021E
200	12	59	40	175	KSA200B1021A
200	12	59	40	175	KSA200B1021E

### CASTORS



						 (daN)	SWIVEL	FIXED	SWIVEL & BRAKE
100	36	125	105x80	80x60	40	90	KSA100B2Z21A	KSA100B3Z21A	KSA100B4Z21A
100	36	125	105x80	80x60	40	90	KSA100B2Z21E	KSA100B3Z21E	KSA100B4Z21E
125	36	155	105x80	80x60	40	120	KSA125B2Z21A	KSA125B3Z21A	KSA125B4Z21A
125	36	155	105x80	80x60	40	120	KSA125B2Z21E	KSA125B3Z21E	KSA125B4Z21E
160	40	195	135x110	105x80	55	135	KSA160B2Z21A	KSA160B3Z21A	KSA160B4Z21A
160	40	195	135x110	105x80	55	135	KSA160B2Z21E	KSA160B3Z21E	KSA160B4Z21E
200	40	235	135x110	105x80	55	175	KSA200B2Z21A	KSA200B3Z21A	KSA200B4Z21A
200	40	235	135x110	105x80	55	175	KSA200B2Z21E	KSA200B3Z21E	KSA200B4Z21E

CASTORS



# LDV Series

## Pressed Steel Castor

- Load capacities from 50kg up to 250kg
- Wheel sizes from 50mm to 200mm
- Strong pressed steel bracket
- Double ball race swivel head

### White Polypropylene

Wheel Dia. (mm)	Tread Width (mm)	Bearing	Top Plate (mm)	Bolt Holes (mm)	Offset (mm)	Overall Height (mm)	Load Cap. (kg)	Swivel	Swivel Braked	Fixed
50	18	Plain	50x50	36x36	32	72	50	LSV050PP	LSV050PPBR	N/A
75	25	Plain	75x60	55x42	34	95	70	LSV075PP	LSV075PPBR	LFV075PP
100	35	Plain	102x84	80x60	34	128	125	LSV100PP	LSV100PPBR	LFV100PP
125	37	Plain	102x84	80x60	34	155	160	LSV125PP	LSV125PPBR	LFV125PP
160	40	Plain	135x110	105x80	48	190	200	LSV160PP	LSV160PPBR	LFV160PP
200	40	RB	135x110	105x80	58	235	250	LSV200PP	LSV200PPBR	LFV200PP



### Grey Rubber Tyre

Wheel Dia. (mm)	Tread Width (mm)	Bearing	Top Plate (mm)	Bolt Holes (mm)	Offset (mm)	Overall Height (mm)	Load Cap. (kg)	Swivel	Swivel Braked	Fixed
50	18	Plain	50x50	36x36	32	72	50	LSV050RP	LSV050RPBR	N/A
75	25	Plain	75x60	55x42	34	95	50	LSV075RP	LSV075RPBR	LFV075RP
100	24	RB	102x84	80x60	34	128	70	LSV100RP	LSV100RPBR	LFV100RP
125	24	RB	102x84	80x60	34	155	100	LSV125RP	LSV125RPBR	LFV125RP
160	22	Plain	135x110	105x80	48	190	135	LSV160RP	LSV160RPBR	LFV160RP
200	30	Plain	135x110	105x80	58	235	205	LSV200RP	LSV200RPBR	LFV200RP



### Black Rubber Tyre

Wheel Dia. (mm)	Tread Width (mm)	Bearing	Top Plate (mm)	Bolt Holes (mm)	Offset (mm)	Overall Height (mm)	Load Cap. (kg)	Swivel	Swivel Braked	Fixed
75	22	RB	75x 60	55x42	32	95	50	LSV075RMB	LSV075RMBBR	LFV075RMB
100	24	RB	102x84	80x60	34	128	70	LSV100RMB	LSV100RMBBR	LFV100RMB
125	24	RB	102x84	80x60	34	155	100	LSV125RMB	LSV125RMBBR	LFV125RMB
160	22	RB	135x110	105x80	48	190	160	LSV160RMB	LSV160RMBBR	LFV160RMB
200	30	RB	135x110	105x80	58	235	205	LSV200RMB	LSV200RMBBR	LFV200RMB



CASTORS

All available in the following types

Top plate



Swivel

Swivel Brake

Fixed

# LDV Series Pressed Steel Castor

- Load capacities from 50kg up to 250kg
- Wheel sizes from 50mm to 200mm
- Strong pressed steel bracket
- Double ball race swivel head

## White Polypropylene

Wheel Dia. (mm)	Tread Width (mm)	Bearing	Bolt Holes (mm)	Offset (mm)	Overall Height (mm)	Load Cap. (kg)	Swivel	Swivel Braked
50	20	Plain	10	23	72	50	LSV050PPBH	LSV050PPBHBR
75	20	Plain	10	30	100	70	LSV075PPBH	LSV075PPBHBR
100	20	Plain	12	38	135	80	LSV100PPBH	LSV100PPBHBR
125	35	Plain	12	38	155	125	LSV125PPBH	LSV125PPBHBR



## Grey Rubber Tyre

Wheel Dia. (mm)	Tread Width (mm)	Bearing	Bolt Holes (mm)	Offset (mm)	Overall Height (mm)	Load Cap. (kg)	Swivel	Swivel Braked
50	18	Plain	10	23	72	50	LSV050RPBH	LSV050RPBHBR
75	21	Plain	10	30	100	70	LSV075RPBH	LSV075RPBHBR
100	27	Plain	12	38	135	80	LSV100RPBH	LSV100RPBHBR
125	27	Plain	12	38	155	100	LSV125RPBH	LSV125RPBHBR



All available in the following types  
Bolt hole



Swivel

Swivel Brake

# Expander Fittings

This range of Nylon fittings allow castors to be fitted to hollow tube constructed equipment and furniture. Available loose or factory fitted to your choice of castor.

Tube Size (Internal mm)		Catalogue Reference	
Min	Max	Round	Square
19	21.5	WR07 19/21.5	n/a
21.5	24	WR07 21.5/24	WR47 21.5/24
24	27	WR07 24/27	WR47 24/27
27	30	WR07 27/30	WR47 27/30
31	35	WR07 31/35	n/a
32	35	n/a	WR47 32/35
36	40	n/a	WR47 36/40

All available in the following types  
Expander Fittings



Round

Square



# MDV Series

## Pressed Steel Castor

- Load capacities from 70kg up to 350kg
- Wheel sizes from 80mm to 200mm
- Strong pressed steel bracket
- Double ball race swivel head
- Bottle cap thread guards

### Red Polyurethane Tyre/Nylon Centre

Wheel Dia. (mm)	Tread Width (mm)	Bearing	Top Plate (mm)	Bolt Holes (mm)	Offset (mm)	Overall Height (mm)	Load Cap. (kg)	Swivel	Swivel Braked	Fixed
80	30	RB	105x80	80x60	40	108	150	MSV080PN1B	MSV080PN1BSWB	MFV080PN1B
100	32	RB	105x80	80x60	40	128	150	MSV100PN1B	MSV100PN1BSWB	MFV100PN1B
125	32	RB	105x80	80x60	40	155	200	MSV125PN1B	MSV125PN1BSWB	MFV125PN1B
160	40	RB	135x110	105x80	55	195	300	MSV160PN1B	MSV160PN1BSWB	MFV160PN1B
200	50	RB	135x110	105x80	55	235	350	MSV200PN1B	MSV200PN1BSWB	MFV200PN1B



### Blue Rubber Tyre

Wheel Dia. (mm)	Tread Width (mm)	Bearing	Top Plate (mm)	Bolt Holes (mm)	Offset (mm)	Overall Height (mm)	Load Cap. (kg)	Swivel	Swivel Braked	Fixed
80	35	RB	105x80	80x60	40	108	150	MSV080RN1B	MSV080RN1BSWB	MFV080RN1B
100	36	RB	105x80	80x60	40	128	160	MSV100RN1B	MSV100RN1BSWB	MFV100RN1B
125	38	RB	105x80	80x60	40	155	200	MSV125RN1B	MSV125RN1BSWB	MFV125RN1B
160	46	RB	135x110	105x80	55	195	300	MSV160RN1B	MSV160RN1BSWB	MFV160RN1B
200	46	RB	135x110	105x80	55	235	350	MSV200RN1B	MSV200RN1BSWB	MFV200RN1B



### White Nylon

Wheel Dia. (mm)	Tread Width (mm)	Bearing	Top Plate (mm)	Bolt Holes (mm)	Offset (mm)	Overall Height (mm)	Load Cap. (kg)	Swivel	Swivel Braked	Fixed
80	32	RB	105x80	80x60	40	108	130	MSV080NY1B	MSV080NY1BSWB	MFV080NY1B
100	36	RB	105x80	80x60	40	128	150	MSV100NY1B	MSV100NY1BSWB	MFV100NY1B
125	40	RB	105x80	80x60	40	155	200	MSV125NY1B	MSV125NY1BSWB	MFV125NY1B
160	50	RB	135x110	105x80	55	195	300	MSV160NY1B	MSV160NY1BSWB	MFV160NY1B
200	50	RB	135x110	105x80	55	235	300	MSV200NY1B	MSV200NY1BSWB	MFV200NY1B



### Grey Rubber Tyre

Wheel Dia. (mm)	Tread Width (mm)	Bearing	Top Plate (mm)	Bolt Holes (mm)	Offset (mm)	Overall Height (mm)	Load Cap. (kg)	Swivel	Swivel Braked	Fixed
80	35	RB	105x80	80x60	40	108	70	MSV080GRP1B	MSV080GRP1BSWB	MFV080GRP1B
100	35	RB	105x80	80x60	40	128	75	MSV100GRP1B	MSV100GRP1BSWB	MFV100GRP1B
125	37	RB	105x80	80x60	40	155	100	MSV125GRP1B	MSV125GRP1BSWB	MFV125GRP1B
160	40	RB	135x110	105x80	55	195	135	MSV160GRP1B	MSV160GRP1BSWB	MFV160GRP1B
200	50	RB	135x110	105x80	55	235	205	MSV200GRP1B	MSV200GRP1BSWB	MFV200GRP1B



### Black Rubber Tyre

Wheel Dia. (mm)	Tread Width (mm)	Bearing	Top Plate (mm)	Bolt Holes (mm)	Offset (mm)	Overall Height (mm)	Load Cap. (kg)	Swivel	Swivel Braked	Fixed
80	35	RB	105x80	80x60	40	108	70	MSV080BRP1B	MSV080BRP1BSWB	MFV080BRP1B
100	35	RB	105x80	80x60	40	128	75	MSV100BRP1B	MSV100BRP1BSWB	MFV100BRP1B
125	37	RB	105x80	80x60	40	155	100	MSV125BRP1B	MSV125BRP1BSWB	MFV125BRP1B
160	40	RB	135x110	105x80	55	195	135	MSV160BRP1B	MSV160BRP1BSWB	MFV160BRP1B
200	50	RB	135x110	105x80	55	235	205	MSV200BRP1B	MSV200BRP1BSWB	MFV200BRP1B



All available in the following types



Swivel



Swivel Brake



Fixed

# MSS Series

## Stainless Steel Castor

- Load capacities from 120kg up to 300kg
- Wheel sizes from 80mm to 200mm
- Strong stainless steel bracket
- Double ball race swivel head
- Plain or roller bearing wheels

### White Nylon

Plain bearing

Wheel bearing Key

Roller bearing

Bolt hole	Wheel Dia. (mm)	Tread Width (mm)	Bolt Hole (mm)	Offset (mm)	Overall Height (mm)	Load Cap. (kg)	Swivel	Swivel Brake	Swivel	Swivel Brake
	80	30	12	37	105	150	MSS080NYBH	MSS080NYBHBR	MSS080NYBBH	MSS080NYBBHBR
100	30	12	37	126	150	MSS100NYBH	MSS100NYBHBR	MSS100NYBBH	MSS100NYBBHBR	
125	40	12	42	150	150	MSS125NYBH	MSS125NYBHBR	MSS125NYBBH	MSS125NYBBHBR	
150	40	12	45	178	200	MSS150NYBH	MSS150NYBHBR	MSS150NYBBH	MSS150NYBBHBR	
160	40	16	55	194	300	MSS160NYBH	MSS160NYBHBR	MSS160NYBBH	MSS160NYBBHBR	
200	50	16	55	232	300	MSS200NYBH	MSS200NYBHBR	MSS200NYBBH	MSS200NYBBHBR	

Top plate	Wheel Dia. (mm)	Tread Width (mm)	Bearing	Top Plate (mm)	Bolt Holes (mm)	Offset (mm)	Total Height (mm)	Load Cap. (kg)	Swivel	Swivel Braked	Fixed
	80	30	Plain	100x85	80x60	37	107	150	MSS080NY	MSS080NYBR	MFS080NY
100	30	Plain	100x85	80x60	37	128	150	MSS100NY	MSS100NYBR	MFS100NY	
125	40	Plain	115x85	80x60	42	155	150	MSS125NY	MSS125NYBR	MFS125NY	
160	40	Plain	140x110	105x80	55	197	300	MSS160NY	MSS160NYBR	MFS160NY	
200	50	Plain	140x110	105x80	55	235	300	MSS200NY	MSS200NYBR	MFS200NY	



### Polyurethane Tyre/Nylon Centre

Plain bearing

Wheel bearing Key

Roller bearing

Bolt hole	Wheel Dia. (mm)	Tread Width (mm)	Bolt Hole (mm)	Offset (mm)	Overall Height (mm)	Load Cap. (kg)	Swivel	Swivel Brake	Swivel	Swivel Brake
	80	30	12	37	105	120	MSS080PNBH	MSS080PNBHBR	MSS080PNBBH	MSS080PNBBHBR
100	30	12	37	126	150	MSS100PNBH	MSS100PNBHBR	MSS100PNBBH	MSS100PNBBHBR	
125	35	12	42	150	150	MSS125PNBH	MSS125PNBHBR	MSS125PNBBH	MSS125PNBBHBR	
150	40	12	45	178	150	MSS150PNBH	MSS150PNBHBR	MSS150PNBBH	MSS150PNBBHBR	
200	50	16	55	232	300	MSS200PNBH	MSS200PNBHBR	MSS200PNBBH	MSS200PNBBHBR	

Top plate	Wheel Dia. (mm)	Tread Width (mm)	Top Plate (mm)	Bolt Holes (mm)	Offset (mm)	Total Height (mm)	Load Cap. (kg)	Swivel	Swivel Brake	Fixed	Swivel	Swivel Brake	Fixed
	80	30	100x85	80x60	37	107	120	MSS080PN	MSS080PNBR	MFS080PN	MSS080PNB	MSS080PNBBR	MFS080PNB
100	30	100x85	80x60	37	128	150	MSS100PN	MSS100PNBR	MFS100PN	MSS100PNB	MSS100PNBBR	MFS100PNB	
125	35	115x85	80x60	42	155	150	MSS125PN	MSS125PNBR	MFS125PN	MSS125PNB	MSS125PNBBR	MFS125PNB	
150	40	115x85	80x60	45	181	150	MSS150PN	MSS150PNBR	MFS150PN	MSS150PNB	MSS150PNBBR	MFS150PNB	
200	50	140x110	105x80	55	235	300	MSS200PN	MSS200PNBR	MFS200PN	MSS200PNB	MSS200PNBBR	MFS200PNB	



CASTORS

### Elastic Rubber Tyre/Polyamide Centre

Bolt hole	Wheel Dia. (mm)	Tread Width (mm)	Bearing	Bolt Hole (mm)	Offset (mm)	Overall Height (mm)	Load Cap. (kg)	Swivel	Swivel Brake
	100	36	RB	12	37	126	150	MSS100RNBBH	MSS100RNBBHBR
125	36	RB	12	42	150	150	MSS125RNBBH	MSS125RNBBHBR	
160	50	RB	16	55	194	300	MSS160RNBBH	MSS160RNBBHBR	
200	50	RB	16	55	232	300	MSS200RNBBH	MSS200RNBBHBR	

Top plate	Wheel Dia. (mm)	Tread Width (mm)	Bearing	Top Plate (mm)	Bolt Holes (mm)	Offset (mm)	Overall Height (mm)	Load Cap. (kg)	Swivel	Swivel Brake	Fixed
	80	36	RB	100x85	80x60	37	108	120	MSS080RNB	MSS080RNBBR	MFS080RNB
100	36	RB	100x85	80x60	37	128	150	MSS100RNB	MSS100RNBBR	MFS100RNB	
125	36	RB	115x85	80x60	42	155	150	MSS125RNB	MSS125RNBBR	MFS125RNB	
160	50	RB	140x110	105x80	55	197	300	MSS160RNB	MSS160RNBBR	MFS160RNB	
200	50	RB	140x110	105x80	55	235	300	MSS200RNB	MSS200RNBBR	MFS200RNB	



All available in the following types

Top plate

Bolt hole



Swivel

Swivel Brake

Fixed

Swivel

Swivel Brake

# MG Series

## Fabricated Steel Castor

- Load capacities from 200kg up to 600kg
- Wheel sizes from 100mm to 200mm
- Robust fabricated steel bracket
- Double ball race swivel head
- Double pedal brake

### Cast Iron

Wheel Dia. (mm)	Tread Width (mm)	Bearing	Top Plate (mm)	Bolt Holes (mm)	Offset (mm)	Overall Height (mm)	Load Cap. (kg)	Swivel	Swivel Braked	Fixed
100	50	RB	135x110	105x80	35	143	300	KSMG100CIB	KBMG100CIB	KFMG100CIB
125	40	BJ	135x110	105x80	39	165	350	KSMG125CIB	KBMG125CIB	KFMG125CIB
150	45	BJ	135x110	105x80	45	190	500	KSMG150CIB	KBMG150CIB	KFMG150CIB
200	45	BJ	135x110	105x80	56	240	600	KSMG200CIB	KBMG200CIB	KFMG200CIB



### Polyurethane Tyre/Cast Iron Centre

Wheel Dia. (mm)	Tread Width (mm)	Bearing	Top Plate (mm)	Bolt Holes (mm)	Offset (mm)	Overall Height (mm)	Load Cap. (kg)	Swivel	Swivel Braked	Fixed
100	40	BJ	135x110	105x80	35	143	300	KSMG100PCB	KBMG100PCB	KFMG100PCB
125	50	BJ	135x110	105x80	39	165	350	KSMG125PCB	KBMG125PCB	KFMG125PCB
150	50	BJ	135x110	105x80	45	190	500	KSMG150PCB	KBMG150PCB	KFMG150PCB
160	50	BJ	135x110	105x80	45	195	500	KSMG160PCB	KBMG160PCB	KFMG160PCB
200	50	BJ	135x110	105x80	56	240	600	KSMG200PCB	KBMG200PCB	KFMG200PCB



### Polyurethane Tyre/Aluminium Centre

Wheel Dia. (mm)	Tread Width (mm)	Bearing	Top Plate (mm)	Bolt Holes (mm)	Offset (mm)	Overall Height (mm)	Load Cap. (kg)	Swivel	Swivel Braked	Fixed
160	50	BJ	135x110	105x80	45	195	500	KSMG160PAB	KBMG160PAB	KFMG160PAB
200	50	BJ	135x110	105x80	56	240	600	KSMG200PAB	KBMG200PAB	KFMG200PAB



### Rubber Tyre/Cast Iron Centre

Wheel Dia. (mm)	Tread Width (mm)	Bearing	Top Plate (mm)	Bolt Holes (mm)	Offset (mm)	Overall Height (mm)	Load Cap. (kg)	Swivel	Swivel Braked	Fixed
150	50	BJ	135x110	105x80	45	190	400	KSMG150RUB	KBMG150RUB	KFMG150RUB
200	50	BJ	135x110	105x80	56	240	500	KSMG200RUB	KBMG200RUB	KFMG200RUB



### White Nylon

Wheel Dia. (mm)	Tread Width (mm)	Bearing	Top Plate (mm)	Bolt Holes (mm)	Offset (mm)	Overall Height (mm)	Load Cap. (kg)	Swivel	Swivel Braked	Fixed
100	50	BJ	135x110	105x80	35	143	270	KSMG100NYB	KBMG100NYB	KFMG100NYB
125	45	BJ	135x110	105x80	39	165	350	KSMG125NYB	KBMG125NYB	KFMG125NYB
150	50	BJ	135x110	105x80	45	190	500	KSMG150NYB	KBMG150NYB	KFMG150NYB
160	50	BJ	135x110	105x80	45	195	450	KSMG160NYB	KBMG160NYB	KFMG160NYB
200	50	RB	135x110	105x80	56	240	500	KSMG200NYB	KBMG200NYB	KFMG200NYB



### Elastic Rubber Tyre/Aluminium Centre

Wheel Dia. (mm)	Tread Width (mm)	Bearing	Top Plate (mm)	Bolt Holes (mm)	Offset (mm)	Overall Height (mm)	Load Cap. (kg)	Swivel	Swivel Braked	Fixed
100	40	BJ	135x110	105x80	35	143	200	KSMG100EAB	KBMG100EAB	KFMG100EAB
125	50	BJ	135x110	105x80	39	165	250	KSMG125EAB	KBMG125EAB	KFMG125EAB
150	50	BJ	135x110	105x80	45	190	300	KSMG150EAB	KBMG150EAB	KFMG150EAB
160	50	BJ	135x110	105x80	45	195	300	KSMG160EAB	KBMG160EAB	KFMG160EAB
200	50	BJ	135x110	105x80	56	240	400	KSMG200EAB	KBMG200EAB	KFMG200EAB



All available in the following types



Swivel



Swivel Brake



Fixed

# HK Series

## Fabricated Steel Castor

- Load capacities from 250kg up to 1300kg
- Wheel sizes from 125mm to 300mm
- Robust heavy duty fabricated steel bracket
- Double ball race swivel head

### Polyurethane Tyre/Cast Iron Centre

Wheel Dia. (mm)	Tread Width (mm)	Bearing	Top Plate (mm)	Bolt Holes (mm)	Offset (mm)	Overall Height (mm)	Load Cap. (kg)	Swivel	Swivel Brake	Fixed
125	50	BJ	149x110	105x80	45	177	400	HKS12520241	HKB12520241	HKF12520241
150	50	BJ	149x110	105x80	49	202	730	HKS15020241	HKB15020241	HKF15020241
200	50	BJ	149x110	105x80	54	252	1000	HKS20020241	HKB20020241	HKF20020241
250	50	BJ	149x110	105x80	70	303	1150	HKS25025241	HKB25025241	HKF25025241
300	50	BJ	149x110	105x80	80	353	1300	HKS30025241	HKB30025241	HKF30025241



### Cast Iron

Wheel Dia. (mm)	Tread Width (mm)	Bearing	Top Plate (mm)	Bolt Holes (mm)	Offset (mm)	Overall Height (mm)	Load Cap. (kg)	Swivel	Swivel Brake	Fixed
125	40	BJ	149x110	105x80	45	177	500	HKS12520441	HKB12520441	HKF12520441
150	45	BJ	149x110	105x80	49	202	600	HKS15020441	HKB15020441	HKF15020441
200	45	BJ	149x110	105x80	54	252	1000	HKS20020441	HKB20020441	HKF20020441
250	54	BJ	149x110	105x80	70	303	1150	HKS25025441	HKB25025441	HKF25025441



### White Nylon

Wheel Dia. (mm)	Tread Width (mm)	Bearing	Top Plate (mm)	Bolt Holes (mm)	Offset (mm)	Overall Height (mm)	Load Cap. (kg)	Swivel	Swivel Brake	Fixed
125	45	BJ	149x110	105x80	45	177	300	HKS12520111	HKB12520111	HKF12520111
150	50	BJ	149x110	105x80	49	202	600	HKS15020111	HKB15020111	HKF15020111
200	50	BJ	149x110	105x80	54	252	1000	HKS20020111	HKB20020111	HKF20020111
250	50	BJ	149x110	105x80	70	303	1100	HKS25025111	HKB25025111	HKF25025111



CASTORS

### Rubber Tyre/Cast Iron Centre

Wheel Dia. (mm)	Tread Width (mm)	Bearing	Top Plate (mm)	Bolt Holes (mm)	Offset (mm)	Overall Height (mm)	Load Cap. (kg)	Swivel	Swivel Brake	Fixed
150	50	BJ	149x110	105x80	49	202	370	HKS15020341	HKB15020341	HKF15020341
200	50	BJ	149x110	105x80	54	252	535	HKS20020341	HKB20020341	HKF20020341
250	54	BJ	149x110	105x80	70	303	615	HKS25025341	HKB25025341	HKF25025341
300	54	BJ	149x110	105x80	80	353	680	HKS30025341	HKB30025341	HKF30025341



### Elastic Rubber Tyre/Aluminium Centre

Wheel Dia. (mm)	Tread Width (mm)	Bearing	Top Plate (mm)	Bolt Holes (mm)	Offset (mm)	Overall Height (mm)	Load Cap. (kg)	Swivel	Swivel Brake	Fixed
125	50	BJ	149x110	105x80	45	177	250	HKS12520341	HKB12520341	HKF12520341



All available in the following types



Swivel



Swivel Brake



Fixed



# KGD Series

## Footmaster multifunctional levelling castors

Fixing Type	Wheel Dia. (mm)	Method Of Operating	Top Plate (mm)	Bolt Holes (mm)	Stem Size (mm)	Overall Height (mm)	Load Cap. (kg)		Part Number
							Static	Dynamic	
Stem	42	Handwheel	-	-	M8x15	71+10	50	25	KGD-40S
Top Plate	50	Handwheel	73x73	58x58	-	82+10	250	125	KGD-60F
Stem	50	Handwheel	-	-	M12x18	82+10	250	125	KGD-60S
Top Plate	50	Ratchet	73x73	58x58	-	82+10	250	125	KGDR-60F
Stem	50	Ratchet	-	-	M12x18	82+10	250	125	KGDR-60S
Top Plate	63	Handwheel	90x90	70x70	-	102+15	500	250	KGD-80F
Top Plate	63	Ratchet	90x90	70x70	-	102+15	500	250	KGDR-80F
Top Plate	75	Handwheel	95x95	70x70	-	120+12	750	375	KGD-100F
Stem	75	Handwheel	-	-	M16x24	120+12	750	375	KGD-100S
Top Plate	75	Hex Spanner	95x95	70x70	-	120+12	1000	500	KGD-120F
Top Plate	97	Hex Spanner	100x100	70x70	-	130+15	1500	750	KGD-150F

Designed to offer 360o swivel castor function, this easily operated range offer mobility, levelling and vibration damping features for light to heavy weight equipment. Footmaster multifunctional castors allow users to move and position large equipment single handily. Levelling can be achieved with ease. Static load capacities of 50kg to 1500kg and Dynamic load capacities of 25kg to 750kg offer unrivalled mobility. (KGD-60F,60S,80F & 80S available in black finish or stainless steel)

All available in the following types



**KGD S Type**  
(Optional Black Finish)



**KGDR S Type**



**KGD F Type**  
(Optional Stainless Steel)

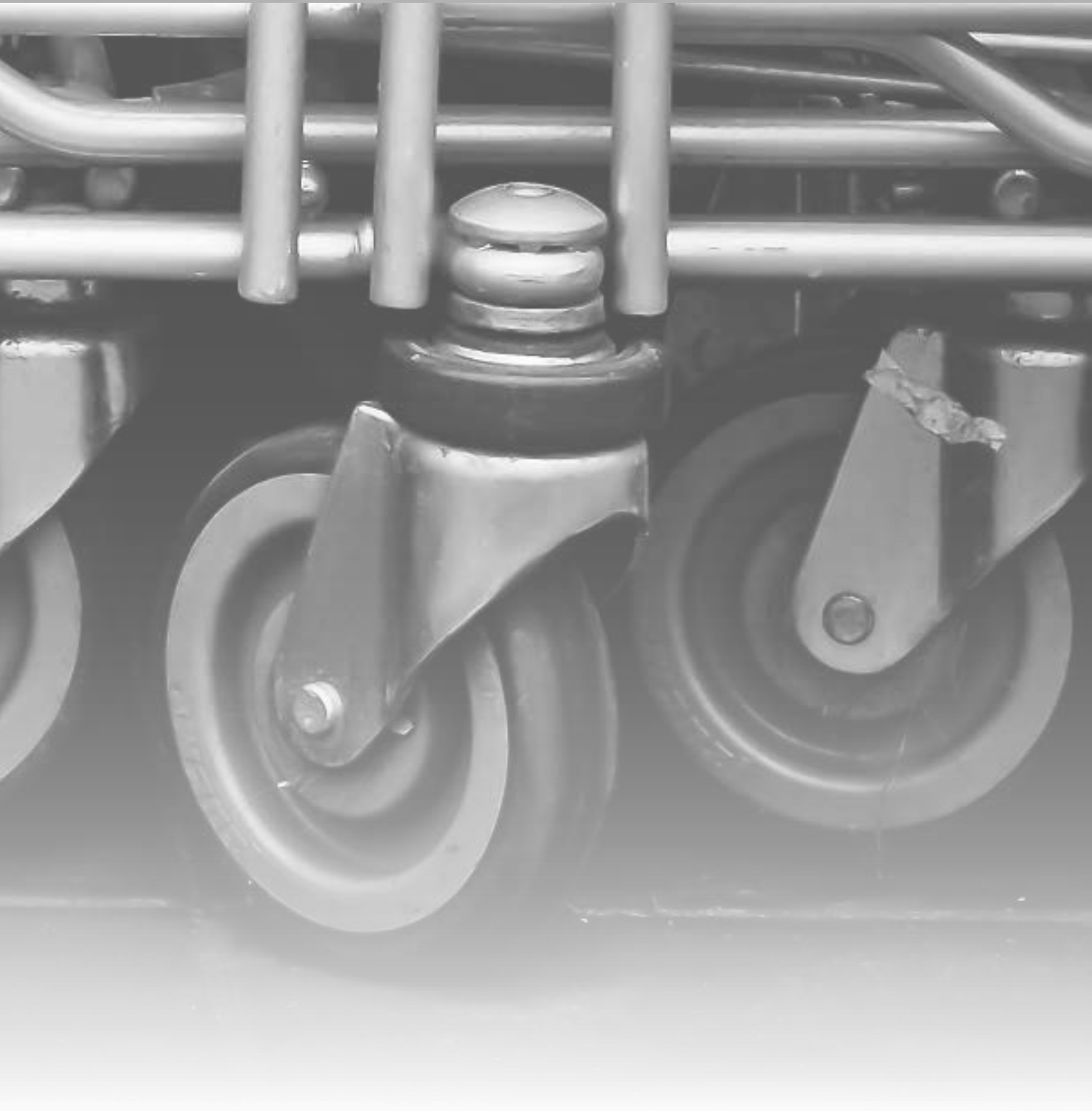



Electric Motors  
Gearboxes  
Drives

# The UK's Largest Stockist of Electric Motors

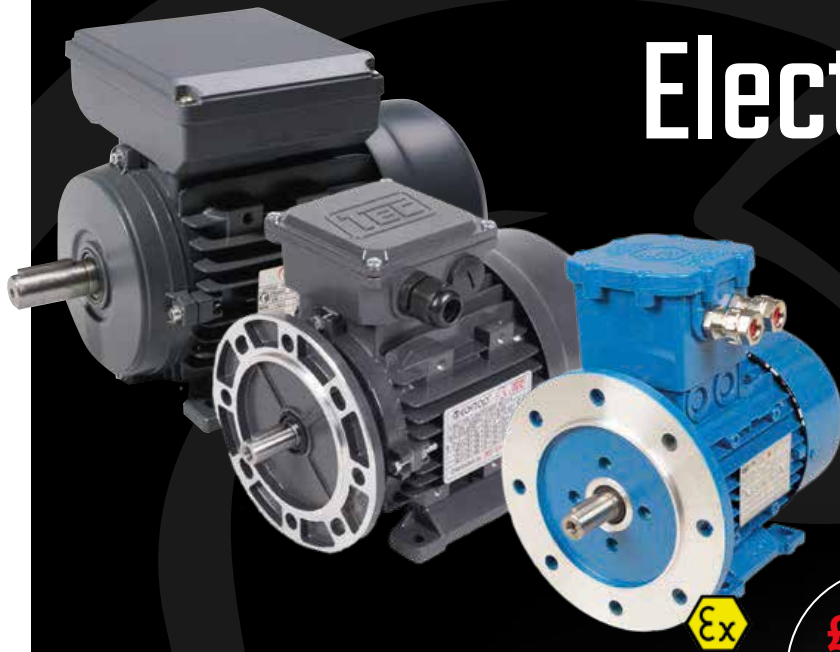

- > 1ph, 3ph & ATEX
- > 0.09 kW – 8 MW
- > 2, 4, 6 & 8 pole
- > Customisation & solutions
- > Application support
- > Online support portal
- > 24/7, 365 call out

**£12m**  
UK stock  
ready for dispatch  
(£50m+ globally)

## Gearboxes

Helical, hypoid & worm boxes



## Drives

IP20, IP66, 1ph & 3ph



**Our Spartan philosophy:**

Dedication | Integrity | Reliability



[www.iadaltd.co.uk](http://www.iadaltd.co.uk)

24/7, 365 - SERVICE THAT NEVER STOPS



## The power of a global network

### Electric Motors



**TECA / TA Aluminium Motors 56-200 Frame**  
Multi mount and highly versatile. IE1, IE2 & IE3 0.09 kW – 37 kW.



**TPC and TCC 1ph Aluminium Motors 56-112 Frame (including 3.7 kW!)**  
TPC: Fan, pump and square law torque applications.  
TCC: High starting torque applications.



**Large Frame Motors**  
Available from stock up to 630 kW 2 and 4 pole, in both standard and compact frames. IE3 efficiency with WIMES specification. MV and HV motors available on short lead times up to 8MW.



**Elprom Zone 1 Exd Motors 63-180 Frame stocked**  
ATEX II 2G Exd IIC T4 Gb IP66 motors 2, 4 and 6 pole stocked. Thermistors as standard and suitable for use with any VSD.



**ECOL Cast Iron 80-355 Frame**  
Multi mount and highly versatile. IE1, IE2 & IE3 0.75 kW – 315 kW.



**TECA BM Brake Motors 71-200 Frame**  
TECA aluminium range with integrated brake at the none drive end fitted with hand release as standard. Multi mount and highly versatile.



**TEC Zone 2 EXNA and Zone 22 EXT D 56-315 Frame**  
Thermistors as standard throughout the range. Multi mount to 280 frame.



**TEC DC motors**  
Many styles, speeds and powers available for a variety of hydraulic applications.



**B48 and B56 Motors**  
Imperial framed B48 and B56 motors available.



**Motor Customisation & Solutions**  
Epoxy painting, anti condensation heaters, special bearings, IP upgrades, slide bases and rails, shaft extensions, retro fit brake motors, vector motors, forcevent motors, flying lead motors and much more.

### Products Include:

- 2/4/6/8/10/12 pole
- 56-400 frame
- Multi mount 56-200 aluminium
- Multi mount 80-280 cast iron
- Fixed feet 315-400 cast iron
- IE1, IE2, IE3 & IE4 efficiency rated motors
- ECA approved IE3 motors
- Increased output IE1 and IE2
- 1ph motors 56-112 frame
- 1ph motors 230 V / 110 V
- 60 Hz 1ph motors also available
- ATEX Exd/EEExde Zone 1 71-355 frame
- ATEX Zone 2/22 56-355 frame
- ATEX Zone 21 & ATEX 1ph
- Brake motors, retro brake fitting
- Two speed dual & tap wound
- Special voltage, special shaft
- Vector encoder motors
- Forced ventilated motors
- In-line helical gearboxes
- Right angle hypoid gearboxes
- Right angle worm gearboxes
- Mechanical speed variators
- Slow speed combination units
- Inverters – IP20, IP66 & IP66 switched
- kVA & MW (Mega Watt) motors

MOTOR  
PUMP &  
GEARBOX

### Gearboxes



**TCNDK Worm Boxes Size 30-150**  
Ratios from 5/1 to 100/1. Helical worm and combination worms available.



**Lightweight, High Efficiency Hypoid Gear Units**  
WAH50 to WAH90. Also interchangeable with worm gears from many popular manufacturers.



**Official UK Varvel Distributor**  
TEC are an in-house build centre for Varvel and can create custom ratios and outputs throughout the RO/RV/RD from stock components, in addition to having access to all of Varvel's extensive product range on short lead times.

### Drives



**TEC Drive General Purpose Drives**  
Available in IP66, IP66 Switched, and IP20 panel mount models from 0.37 kW up to 22 kW. Produced with simplicity and reliability in mind, it is the ideal drive for use in many applications, particularly modular conveyor lines, fans and pumps. Other models available on short lead times up to 250 kW.



# MS Series

## Three-Phase Asynchronous Motors Aluminum Housing

**MS** series aluminum housing three-phase asynchronous motors with the latest design manufactured using high quality materials and conforming to provide exceptional IEC standard.

**MS** motors offer a high performance level along with safe and reliable low maintenance operation, whilst giving low noise levels and low vibration levels - all within a lightweight and simple construction.



### MS/MSD Series Dimensional Drawings

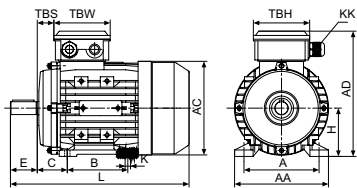

56-160 IM B3

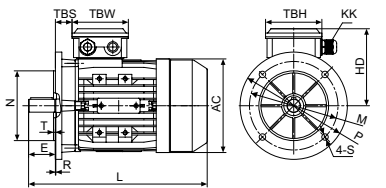

56-160 IM B5

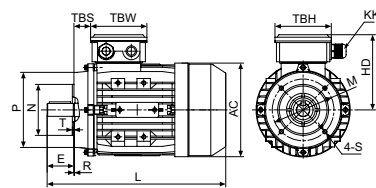

56-160 IM B14

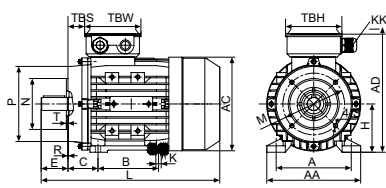

56-160 IM B34

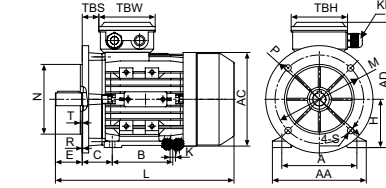

56-160 IM B35

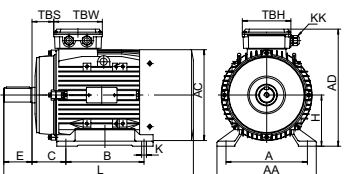
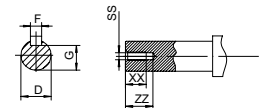

180-200 IM B3

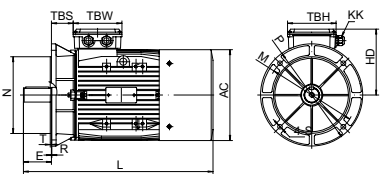

180-200 IM B5

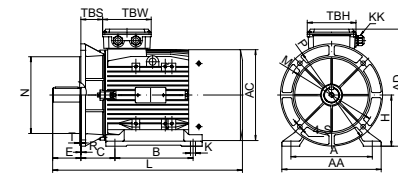

180-200 IM B35







# MSBCCL Series

## Asynchronous Three-Phase Brake Motors With Squirrel Cage Rotor - Direct Current Brake

▪ **MSBCCL series-enclosed construction externally ventilated-sizes 63~200**

The brake-motors of the MSBCCL series result from coupling an asynchronous three-phase motor and an electromagnetic D.C. brake unit. Due to their reliability and operating safety, as well as their quick braking time (connection & disconnection time = 5~80 milliseconds) they are suitable for a great variety of applications, such as:

- Braking of loads or torques on the driving shaft.
- Braking of rotating masses to reduce any lost-time.
- Braking operations to increase the set-up precision.
- Braking of machine parts, according to safely rules.



MOTOR  
PUMP &  
GEARBOX

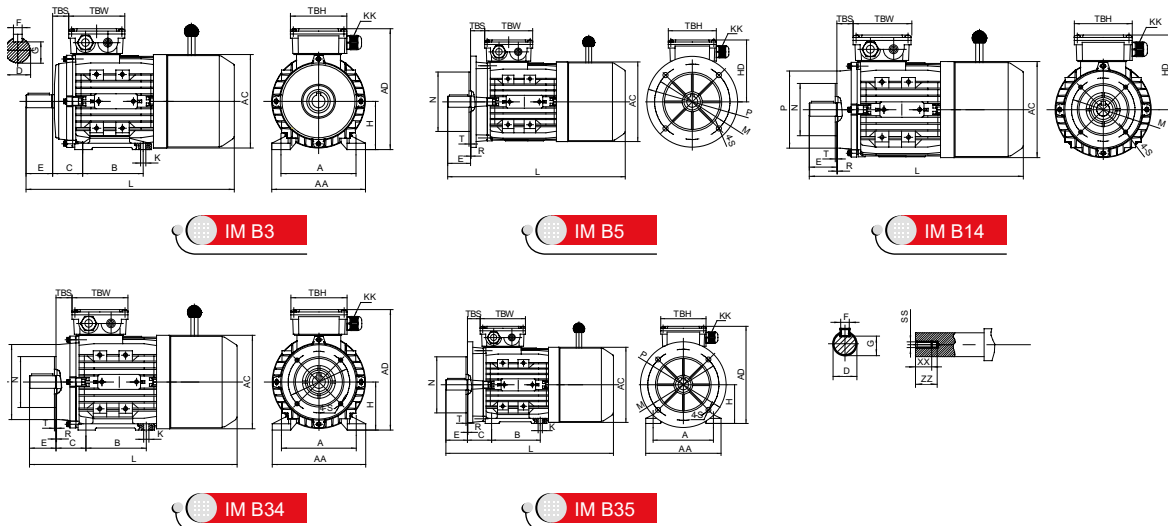



## Overall & Installation Dimensions

FRAME	Foot Mounting				Shaft								General							
	H	A	B	C	D	E	F	G	K	SS	XX	ZZ	AA	AD	HD	AC	L	TBS	TBW	TBH
56	56	90	71	36	Φ9	20	3	7.2	5.8*8.8	M4	10	14	110	152	96	Φ110	233	14	88	88
63	63	100	80	40	Φ11	23	4	8.5	7*10	M4	10	14	120	169	106	Φ121	265	14	94	94
71 <sup>3*</sup>	71	112	90	45	Φ14	30	5	11	7*10	M5	12	17	132	184	113	Φ139	287/301	20	94	94
80	80	125	100	50	Φ19	40	6	15.5	10*13	M6	16	21	160	211	131	Φ156	340	27	105	105
90S	90	140	100	56	Φ24	50	8	20	10*13	M8	19	25	175	228	138	Φ175	356	30	105	105
90L1/L2	90	140	125	56	Φ24	50	8	20	10*13	M8	19	25	175	228	138	Φ175	381/411	30	105	105
100 <sup>3*</sup>	100	160	140	63	Φ28	60	8	24	12*15	M10	22	30	198	248	148	Φ196	434/452	26	105	105
112	112	190	140	70	Φ28	60	8	24	12*15	M10	22	30	220	278	166	Φ221	465	32	112	112
132S	132	216	140	89	Φ38	80	10	33	12*15	M12	28	37	252	316	184	Φ256	518	38	112	112
132ML	132	216	178	89	Φ38	80	10	33	12*15	M12	28	37	252	316	184	Φ256	556/582	38	112	112
160ML	160	254	210/254	108	Φ42	110	12	37	15*19	M16	36	45	290	382	222	Φ313	701	64	143	143

FRAME	KK	B5						B14						B5R						B14B					
		N	M	P	S	T	R	N	M	P	S	T	R	N	M	P	T	S	R	N	M	P	T	S	R
56	1-M16*1.5	Φ80	Φ100	Φ120	Φ7	3	0	Φ50	Φ65	Φ80	M5	2.5	0												
63	1-M16*1.5	Φ95	Φ115	Φ140	Φ10	3	0	Φ60	Φ75	Φ90	M5	2.5	0												
71	1-M20*1.5	Φ110	Φ130	Φ160	Φ10	3.5	0	Φ70	Φ85	Φ105	M6	2.5	0	Φ95	Φ115	Φ140	3	Φ10	0	Φ95	Φ115	Φ140	3	M8	0
80	1-M20*1.5	Φ130	Φ165	Φ200	Φ12	3.5	0	Φ80	Φ100	Φ120	M6	3	0	Φ110	Φ130	Φ160	3.5	Φ10	0	Φ110	Φ130	Φ160	3.5	M8	0
90	1-M20*1.5	Φ130	Φ165	Φ200	Φ12	3.5	0	Φ95	Φ115	Φ140	M8	3	0	Φ110	Φ130	Φ160	3.5	Φ10	0	Φ110	Φ130	Φ160	3.5	M8	0
100	2-M20*1.5	Φ180	Φ215	Φ250	Φ15	4	0	Φ110	Φ130	Φ160	M8	3.5	0	Φ130	Φ165	Φ200	3.5	Φ12	0	Φ130	Φ165	Φ200	3.5	M10	0
112	2-M25*1.5	Φ180	Φ215	Φ250	Φ15	4	0	Φ110	Φ130	Φ160	M8	3.5	0	Φ130	Φ165	Φ200	3.5	Φ12	0	Φ130	Φ165	Φ200	3.5	M10	0
132	2-M25*1.5	Φ230	Φ265	Φ300	Φ15	4	0	Φ130	Φ165	Φ200	M10	3.5	0	Φ180	Φ215	Φ250	4	Φ15	0	Φ180	Φ215	Φ250	4	M12	0
160	2-M32*1.5	Φ250	Φ300	Φ350	Φ19	5	0	Φ180	Φ215	Φ250	M12	4	0												

## REACH brake data (fitted as standard)

Frame size	Brake type	Brake torque (Speed 100r/min) (Nm)	Brake rated power(20°C) (W)	Delay time when power on (ms)	Brake time (ms)	Pick in time when power off (ms)
56-71	06	4	20	15	30	40
80	08	8	25	15	32	50
90	10	16	30	25	45	69
100	12	32	40	26	56	108
112	14	60	50	27	57	190
132	16	80	55	30	60	200
160	18	150	85	35	78	260

## INTORQ brake data

Frame size	Brake type	Brake torque (Speed 100r/min) (Nm)	Brake rated power (20°C) (W)	Delay time when power on (ms)	Brake time (ms)	Pick in time when power off (ms)
56-71	06	4	20	10	23	52
80	08	8	25	15	31	60
90	10	16	30	31	50	65
100	12	32	40	39	64	145
112	14	60	50	26	51	205
132	16	80	55	40	70	258



MOTOR  
PUMP &  
GEARBOX



## MSB Series Motors Technical Data (at 50Hz)

Model	Power (kW)	Current (A)			Current (A)			Current (A)			Speed (r/ min)	Eff			Power factor	T <sub>st</sub> /T <sub>n</sub> (Times)	T <sub>max</sub> /T <sub>n</sub> (Times)	T <sub>max</sub> /T <sub>s</sub> (Times)	I <sub>st</sub> /I <sub>n</sub> (Times)	Noise dB(A)
		220V	380V	660V	230V	400V	690V	240V	415V	720V		100%	75%	50%						
MSB 631-6	0.09	0.75	0.44	0.25	0.72	0.41	0.24	0.69	0.40	0.23	890	50.7	47.6	39.8	0.62	2	2.2	1.9	2.9	50
MSB 632-6	0.12	0.97	0.56	0.32	0.93	0.54	0.31	0.89	0.52	0.30	895	53.7	50.9	43.2	0.60	2.3	2.2	2.1	2.8	50
MSB 711-6	0.18	1.11	0.64	0.37	1.06	0.61	0.35	1.02	0.59	0.34	905	63.0	61.6	55.4	0.67	2.15	2.4	2	3.5	52
MSB 712-6	0.25	1.56	0.90	0.52	1.49	0.86	0.50	1.43	0.83	0.48	885	62.6	62.0	55.8	0.67	2.05	2.3	2.05	3.2	52
MSB 713-6	0.37	2.32	1.34	0.77	2.22	1.28	0.74	2.13	1.23	0.71	890	65.4	64.4	58.2	0.64	2.3	2.5	2.3	3.4	54
MSB 801-6	0.37	2.06	1.19	0.69	1.97	1.13	0.66	1.89	1.09	0.63	920	68.1	67.7	62.2	0.69	1.95	2.25	1.8	3.7	56
MSB 802-6	0.55	2.74	1.59	0.91	2.62	1.51	0.87	2.51	1.45	0.84	920	72.5	73.0	69.3	0.73	2.25	2.45	2.05	4.3	56
MSB 803-6	0.75	3.65	2.11	1.22	3.49	2.01	1.16	3.34	1.93	1.11	910	72.9	74.2	71.3	0.74	2.2	2.4	2.1	4.1	58
MSB 90S-6	0.75	3.83	2.22	1.28	3.67	2.11	1.22	3.52	2.03	1.17	920	72.5	73.3	70.0	0.71	1.8	2.2	1.7	4.1	59
MSB 90L1-6	1.1	5.47	3.17	1.82	5.23	3.01	1.74	5.01	2.90	1.67	910	73.5	75.2	72.9	0.72	1.95	2.25	1.85	4.2	59
MSB 90L2-6	1.5	7.12	4.12	2.37	6.81	3.92	2.27	6.53	3.78	2.18	900	74.7	77	75.5	0.74	2.1	2.3	1.9	4.2	60
MSB 100L1-6	1.5	6.77	3.92	2.26	6.47	3.72	2.16	6.20	3.59	2.07	935	78.5	79.9	78.2	0.74	2.05	2.35	1.8	5	61
MSB 100L2-6	2.2	9.87	5.71	3.29	9.44	5.43	3.15	9.04	5.23	3.01	950	77	78.4	77.8	0.76	2.2	2.2	1.3	6	63
MSB 112M-6	2.2	9.3	5.38	3.10	8.89	5.11	2.96	8.52	4.93	2.84	925	79.2	81.8	81.7	0.78	1.9	2.25	1.75	4.7	64
MSB 112L-6	3	12.9	7.49	4.31	12.4	7.12	4.13	11.9	6.86	3.95	950	79	80.9	80.9	0.77	2.2	2.2	1.3	6	64
MSB 132S-6	3	12.5	7.22	4.16	11.9	6.86	3.98	11.4	6.61	3.81	955	82.5	84.5	84.3	0.77	1.7	2.15	1.45	5.3	64
MSB 132M1-6	4	16.2	9.39	5.40	15.5	8.92	5.17	14.9	8.59	4.95	965	85.2	85.8	84.4	0.76	2.3	2.9	1.6	6.6	68
MSB 132M2-6	5.5	21.5	12.4	7.16	20.6	11.8	6.9	19.7	11.4	6.6	960	85.9	87.2	86.8	0.78	2.5	2.7	1.7	6.7	68
MSB 132L-6	7.5	30.1	17.4	10.0	28.8	16.5	9.6	27.6	15.9	9.2	960	85	86.4	86.4	0.77	2	2	1.3	6.5	68
MSB 160M-6	7.5	30.3	17.6	10.1	29.0	16.7	9.7	27.8	16.1	9.3	970	86.8	87.6	86.7	0.75	2.1	2.7	1.65	6.1	68
MSB 160L-6	11	42.5	24.6	14.2	40.7	23.4	13.6	39.0	22.5	13.0	965	87.2	88.6	88.6	0.78	2.25	2.35	1.5	6.9	73
MSB 711-8	0.09	0.97	0.56	0.32	0.93	0.54	0.31	0.89	0.52	0.30	680	44.9	39.6	31.1	0.54	2.3	2.6	2.2	2.4	50
MSB 712-8	0.12	1.15	0.67	0.38	1.10	0.63	0.37	1.06	0.61	0.35	680	51.7	47.1	38.4	0.53	2.5	2.75	2.5	2.7	50
MSB 713-8	0.18	1.51	0.88	0.50	1.45	0.83	0.48	1.39	0.80	0.46	670	55.8	52.5	44.4	0.56	2.3	2.5	2.4	2.8	52
MSB 801-8	0.18	1.24	0.72	0.41	1.18	0.68	0.39	1.13	0.66	0.38	705	64.4	61.3	53.9	0.59	2.2	2.65	2	3.6	52
MSB 802-8	0.25	1.64	0.95	0.55	1.57	0.90	0.52	1.51	0.87	0.50	700	66.3	64.3	57.8	0.60	2.1	2.5	2.05	3.5	52
MSB 90S-8	0.37	2.37	1.37	0.79	2.26	1.30	0.75	2.17	1.25	0.72	690	66.3	65.4	59.6	0.62	1.55	2	1.5	3.2	56
MSB 90L-8	0.55	3.26	1.89	1.09	3.12	1.79	1.04	2.99	1.73	1.00	680	69.0	69.9	65.8	0.64	1.6	1.95	1.6	3.3	56
MSB 100L1-8	0.75	3.88	2.24	1.29	3.71	2.13	1.24	3.55	2.06	1.18	700	75.2	74.8	70.8	0.68	2.1	2.55	1.95	4.4	59
MSB 100L2-8	1.1	5.16	2.99	1.72	4.94	2.84	1.65	4.73	2.74	1.58	685	74.6	76.7	75.1	0.75	1.8	2.15	1.65	4.1	59
MSB 112M-8	1.5	7.24	4.19	2.41	6.93	3.98	2.31	6.64	3.84	2.21	700	78.3	78.9	76.4	0.69	2.2	2.5	2.1	4.5	61
MSB 132S-8	2.2	10.0	5.81	3.35	9.6	5.52	3.20	9.20	5.32	3.07	705	78.8	80.7	79.6	0.73	1.8	2.25	1.65	4.5	64
MSB 132M-8	3	13.0	7.51	4.33	12.4	7.14	4.14	11.9	6.88	3.96	705	80.9	82.6	81.9	0.75	2.1	2.5	1.8	5.1	64
MSB 160M1-8	4	18.0	10.4	5.99	17.2	9.88	5.73	16.5	9.53	5.49	710	81.7	83.0	82.0	0.72	1.8	2.25	1.5	4.7	68
MSB 160M2-8	5.5	23.4	13.5	7.79	22.4	12.9	7.45	21.4	12.4	7.14	715	84.6	85.7	84.9	0.73	2.15	2.55	1.6	5.2	68
MSB 160L-8	7.5	30.3	17.5	10.1	29.0	16.67	9.66	27.8	16.1	9.26	715	85.8	87.1	86.7	0.76	2.15	2.45	1.4	5.4	68

MOTOR  
PUMP &  
GEARBOX



# ML Series

## Single-Phase Capacitor Start and Capacitor Run Asynchronous Motors Aluminum Housing

**ML** series aluminum housing single-phase dual-capacitor asynchronous motors, with latest design in entirety, are made of selected quality materials and conform to the IEC standard. **ML** motors have good performance, safety and reliable operation, the multiple of starting torque is up to 2.5. These motors are typically used on applications where a high starting torque and high overload are required - such as air compressors, pumps, and many other small machines. Capable of 15 times/hour Start/Stops.

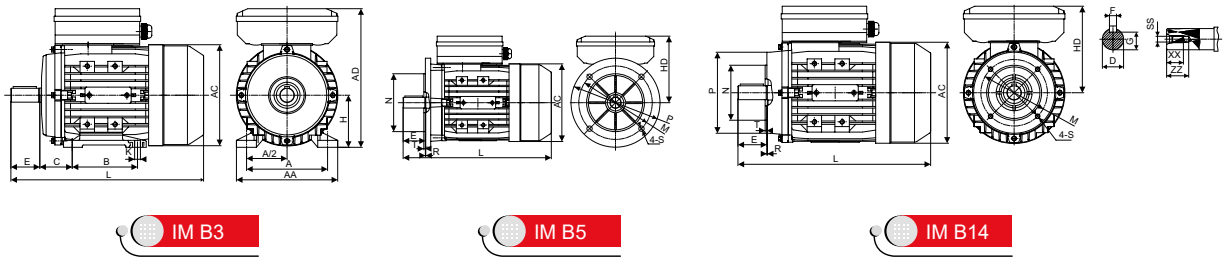

### Overall & Installation Dimensions

FRAME	Mounting Dimensions									Overall Dimensions					Shaft End Screw Dimensions		
	H	A	B	C	D	E	F	G	K	AA	AD	HD	AC	L	SS	XX	ZZ
ML 63	63	100	80	40	Φ11	23	4	8.5	7×10	120	179	116	Φ121	220	M4	10	14
ML 71	71	112	90	45	Φ14	30	5	11	7×10	132	194	123	Φ139	255	M5	12	17
ML 80	80	125	100	50	Φ19	40	6	15.5	10×13	160	223	143	Φ156	290	M6	16	21
ML 90S	90	140	100	56	Φ24	50	8	20	10×13	175	240	150	Φ175	337	M8	19	25
ML 90L	90	140	125	56	Φ24	50	8	20	10×13	175	240	150	Φ175	367	M8	19	25
ML 100L	100	160	140	63	Φ28	60	8	24	12×15	198	271	171	Φ196	403(421)	M10	22	30
ML 112M	112	190	140	70	Φ28	60	8	24	12×15	220	297	185	Φ221	431	M10	22	30

FRAME	KK	B5						B14						B5R						B14B						
		N	M	P	S	T	R	N	M	P	S	T	R	N	M	P	T	S	R	N	M	P	T	S	R	
ML 63	1-M20*1.5	Φ95	Φ115	Φ140	Φ10	3	0	Φ60	Φ75	Φ90	M5	2.5	0													
ML 71	1-M20*1.5	Φ110	Φ130	Φ160	Φ10	3.5	0	Φ70	Φ85	Φ105	M6	2.5	0	Φ95	Φ115	Φ140	3	Φ10	0	Φ95	Φ115	Φ140	3	M8	0	
ML 80	1-M20*1.5	Φ130	Φ165	Φ200	Φ12	3.5	0	Φ80	Φ100	Φ120	M6	3	0	Φ110	Φ130	Φ160	3.5	Φ10	0	Φ110	Φ130	Φ160	3.5	M8	0	
ML 90	1-M20*1.5	Φ130	Φ165	Φ200	Φ12	3.5	0	Φ95	Φ115	Φ140	M8	3	0	Φ110	Φ130	Φ160	3.5	Φ10	0	Φ110	Φ130	Φ160	3.5	M8	0	
ML 100	1-M20*1.5	Φ180	Φ215	Φ250	Φ15	4	0	Φ110	Φ130	Φ160	M8	3.5	0	Φ130	Φ165	Φ200	3.5	Φ12	0	Φ130	Φ165	Φ200	3.5	M10	0	
ML 112	1-M25*1.5	Φ180	Φ215	Φ250	Φ15	4	0	Φ110	Φ130	Φ160	M8	3.5	0	Φ130	Φ165	Φ200	3.5	Φ12	0	Φ130	Φ165	Φ200	3.5	M10	0	



MOTOR  
PUMP &  
GEARBOX

## Technical Data (at 230V/50Hz)

Model	Power (kW)	Current (A)	Speed (r/min)	Eff (%)	Power factor (cos φ)	T <sub>st</sub> /T <sub>n</sub> (Times)	T <sub>max</sub> /T <sub>n</sub> (Times)	Starting Current(A)	Run Capacitor (μf/V)	Start Capacitor (μf/V)	Noise dB(A)	W.T (kg)	Inertia (kg·m <sup>2</sup> )
ML631-2	0.18	1.36	2820	62	0.93	1.9	1.8	7	8μf/450V	30μf/250V	70	3.9	0.000141
ML632-2	0.25	1.71	2800	67.5	0.94	2.3	1.8	8	10μf/450V	30μf/250V	70	4.4	0.000168
ML711-2	0.37	2.40	2780	70.5	0.95	2.5	1.6	12	12μf/450V	40μf/250V	75	6.2	0.000330
ML712-2	0.55	3.31	2790	74.5	0.97	2.5	1.8	20	16μf/450V	50μf/250V	75	7	0.000437
ML801-2	0.75	4.25	2840	77.5	0.99	2.5	1.8	30	20μf/450V	75μf/250V	75	9	0.000781
ML802-2	1.1	6.08	2850	79.5	0.99	2.3	1.8	40	30μf/450V	120μf/250V	78	10.3	0.000938
ML90S-2	1.5	8.23	2860	80	0.99	2.5	1.8	56	40μf/450V	200μf/300V	80	13.8	0.001512
ML90M-2	1.8	9.76	2860	81	0.99	2.5	1.8	65	40μf/450V	200μf/300V	80	15.1	0.001752
ML90L-2	2.2	11.9	2850	81	0.99	2.5	1.75	15	50μf/450V	250μf/300V	80	16.8	0.001995
ML100L-2	3	17.7	2830	75	0.98	2.5	1.63	110	60μf/450V	300μf/300V	83	25	0.004803
ML112M1-2	3.7	19.9	2900	82.5	0.98	2.5	1.8	155	60μf/450V	400μf/300V	84	31	0.007170
ML112M2-2	4	21.3	2900	83.5	0.98	2.5	1.8	165	60μf/450V	400μf/300V	84	33	0.007453
ML631-4	0.12	1.01	1380	54.5	0.95	2.5	1.65	6	8μf/450V	30μf/250V	65	4.1	0.000291
ML632-4	0.18	1.36	1340	60	0.96	2.3	1.43	6	10μf/450V	30μf/250V	65	4.5	0.000340
ML711-4	0.25	1.78	1415	63	0.97	2.5	1.7	10	12μf/450V	40μf/250V	65	5.9	0.000598
ML712-4	0.37	2.53	1410	65.5	0.97	2.3	1.6	15	16μf/450V	50μf/250V	68	6.9	0.000760
ML800-4	0.37	2.52	1420	66.5	0.96	2.5	1.8	15	16μf/450V	50μf/250V	68	8.5	0.001105
ML801-4	0.55	3.52	1420	71.5	0.95	2.5	1.8	20	20μf/450V	75μf/250V	70	9.6	0.001380
ML802-4	0.75	4.56	1420	73	0.98	2.5	1.75	27	25μf/450V	100μf/250V	70	10.9	0.001656
ML90S-4	1.1	6.62	1420	76	0.95	2.5	1.7	40	35μf/450V	150μf/250V	73	13.8	0.002510
ML90L-4	1.5	8.56	1420	78.5	0.97	2.5	1.75	55	40μf/450V	200μf/300V	75	16.7	0.003252
ML100L0-4	1.84	10.3	1440	79.5	0.98	2.3	1.62	60	50μf/450V	200μf/300V	77	21	0.006804
ML100L1-4	2.2	12.1	1440	80.5	0.98	2.5	1.65	80	50μf/450V	250μf/300V	78	22.8	0.008045
ML100L2-4	3	16.4	1445	83	0.96	2.4	1.75	110	60μf/450V	300μf/300V	78	28.7	0.010543
ML112M1-4	3.7	19.7	1430	83.5	0.98	2.4	1.75	130	60μf/450V	400μf/300V	79	31	0.013608
ML112M2-4	4	21.3	1435	83.5	0.98	2.5	1.75	140	60μf/450V	400μf/300V	79	32.8	0.014485
ML711-6	0.18	1.3	930	60	0.97	2.3	1.72	7	10μf/450V	40μf/250V	68	6.7	0.000965
ML801-6	0.37	2.5	935	67	0.97	2.2	1.55	13	16μf/450V	50μf/250V	68	10.1	0.001829
ML802-6	0.55	3.5	935	71	0.97	2.2	1.45	20	20μf/450V	75μf/250V	70	10.8	0.002366
ML90S-6	0.75	4.7	945	71	0.97	2.1	1.45	35	30μf/450V	150μf/250V	70	14.2	0.003534
ML90L-6	1.1	6.7	945	74	0.96	2.5	1.45	45	45μf/450V	200μf/300V	70	17.3	0.004792
ML100L-6	1.5	8.73	960	77	0.97	2.3	1.55	60	45μf/450V	200μf/300V	72	23.8	0.010784
ML112M-6	2.2	12.0	965	82	0.97	2.5	1.7	100	60μf/450V	400μf/300V	75	31.2	0.019523

MOTOR  
PUMP &  
GEARBOX



# MY/MYT Series

## Single-Phase Capacitor Run Asynchronous Motors

### Aluminum Housing

**MY/MYT** series aluminum housing single-phase capacitor-run asynchronous motors, with latest design in entirety, are made of selected quality materials and conform to the IEC standard. **MY** motors offer a high performance level along with safe and reliable low maintenance operation, whilst giving low noise levels and low vibration levels - all within a lightweight and simple construction. These motors are suitable for applications with low starting torque requirements and long-term continuous operation - such as home electric appliances, pumps, fans, and recording meters, etc.

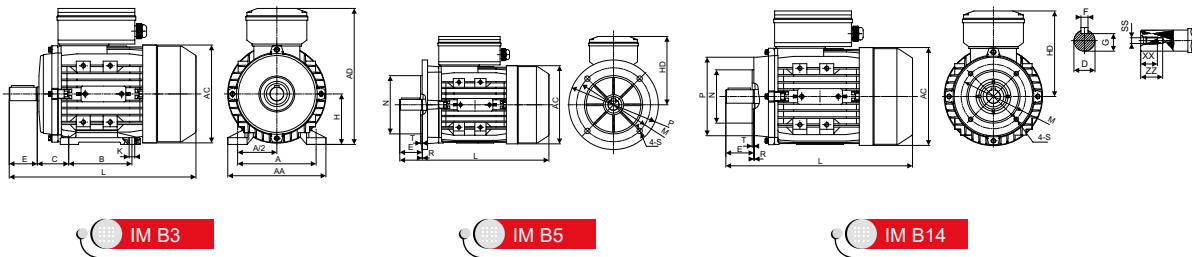

MOTOR  
PUMP &  
GEARBOX

#### Overall & Installation Dimensions

FRAME	Mounting Dimensions									Overall Dimensions					Shaft End Screw Dimensions		
	H	A	B	C	D	E	F	G	K	AA	AD	HD	AC	L	SS	XX	ZZ
MY 56	56	90	71	36	Φ9	20	3	7.2	5.8×8.8	110	144	88	Φ110	196	M4	9	12
MY 63	63	100	80	40	Φ11	23	4	8.5	7×10	120	181	118	Φ121	220	M4	10	14
MY 71	71	112	90	45	Φ14	30	5	11	7×10	132	196	125	Φ139	241/255	M5	12	17
MY 80	80	125	100	50	Φ19	40	6	15.5	10×13	160	226	146	Φ156	290	M6	16	21
MY 90S	90	140	100	56	Φ24	50	8	20	10×13	175	243	153	Φ175	312	M8	19	25
MY 90L	90	140	125	56	Φ24	50	8	20	10×13	175	243	153	Φ175	337/367	M8	19	25
MY 100L	100	160	140	63	Φ28	60	8	24	12×15	198	265	165	Φ196	368/386	M10	22	30

FRAME	KK	B5						B14						B5R						B14B						
		N	M	P	S	T	R	N	M	P	S	T	R	N	M	P	T	S	R	N	M	P	T	S	R	
MY 56	1-M16*1.5	Φ80	Φ100	Φ120	Φ7	3	0	Φ50	Φ65	Φ80	M5	2.5	0													
MY 63	1-M20*1.5	Φ95	Φ115	Φ140	Φ10	3	0	Φ60	Φ75	Φ90	M5	2.5	0							Φ80	Φ100	Φ120	3	M6	0	
MY 71	1-M20*1.5	Φ110	Φ130	Φ160	Φ10	3.5	0	Φ70	Φ85	Φ105	M6	2.5	0	Φ95	Φ115	Φ140	3	Φ10	0	Φ95	Φ115	Φ140	3	M8	0	
MY 80	1-M20*1.5	Φ130	Φ165	Φ200	Φ12	3.5	0	Φ80	Φ100	Φ120	M6	3	0	Φ110	Φ130	Φ160	3.5	Φ10	0	Φ110	Φ130	Φ160	3.5	M8	0	
MY 90	1-M20*1.5	Φ130	Φ165	Φ200	Φ12	3.5	0	Φ95	Φ115	Φ140	M8	3	0	Φ110	Φ130	Φ160	3.5	Φ10	0	Φ110	Φ130	Φ160	3.5	M8	0	
MY 100	1-M20*1.5	Φ180	Φ215	Φ250	Φ15	4	0	Φ110	Φ130	Φ160	M8	3.5	0	Φ130	Φ165	Φ200	3.5	Φ12	0	Φ130	Φ165	Φ200	3.5	M10	0	



## Technical Data (at 230V/50Hz)

Model	Power (kW)	Current (A)	Speed (r/min)	Eff (%)	Power factor (cos Φ)	T <sub>st</sub> /T <sub>n</sub> (Times)	T <sub>max</sub> /T <sub>n</sub> (Times)	Starting Current(A)	Run Capacitor (μF/V)	Noise dB(A)	W.t. (Kg)	Inertia (kg*m <sup>2</sup> )
MY561-2	0.09	0.81	2750	51	0.95	0.7	1.7	2	5μf/450V	67	3	0.00093
MY562-2	0.12	0.89	2800	61	0.96	0.7	1.8	3.1	6μf/450V	67	3.2	0.00120
MY631-2	0.18	1.31	2770	62	0.96	0.55	1.8	4.5	8μf/450V	70	3.8	0.00141
MY632-2	0.25	1.65	2780	68	0.97	0.55	1.8	6	10μf/450V	70	4.5	0.00168
MY633-2	0.37	2.51	2780	67.5	0.95	0.46	1.65	8	12μf/450V	75	5	0.00216
MY634-2	0.55	3.52	2740	70	0.97	0.46	1.55	12	16μf/450V	75	5.5	0.00249
MY711-2	0.37	2.54	2780	68	0.93	0.5	1.64	9.5	12μf/450V	75	5.5	0.00330
MY712-2	0.55	3.45	2800	73	0.95	0.5	1.8	14.5	16μf/450V	75	6.7	0.00356
MY713-2	0.75	4.45	2840	75.5	0.97	0.48	1.8	20	25μf/450V	75	7	0.00436
MY801-2	0.75	4.51	2810	73	0.99	0.45	1.75	19	25μf/450V	75	8.9	0.00789
MY802-2	1.1	6.30	2810	77.5	0.98	0.45	1.8	30	35μf/450V	78	11	0.01174
MY803-2	1.5	8.48	2820	78.5	0.98	0.34	1.68	40	40μf/450V	80	12.7	0.01430
MY90S-2	1.5	8.45	2820	78	0.99	0.33	1.72	35	45μf/450V	80	12.2	0.01512
MY90L-2	2.2	12.08	2850	80	0.99	0.29	1.8	61	60μf/450V	80	15.5	0.01983
MY100L-2	3	16.7	2860	79	0.99	0.35	1.8	73	80μf/450V	83	23.1	0.04803
MY561-4	0.06	0.55	1410	49	0.97	0.7	1.8	1.5	4μf/450V	63	2.9	0.000215
MY562-4	0.09	0.78	1390	51	0.99	0.7	1.65	8	6μf/450V	63	3.4	0.000240
MY631-4	0.12	0.97	1400	55	0.98	0.7	1.75	2.5	8μf/450V	65	3.4	0.000298
MY632-4	0.18	1.35	1380	59	0.98	0.6	1.65	3.5	10μf/450V	65	4.4	0.000373
MY633-4	0.25	1.77	1380	62.5	0.98	0.55	1.6	5	12μf/450V	65	5	0.000448
MY710-4	0.18	1.33	1420	60.5	0.97	0.48	1.65	4	10μf/450V	65	5.2	0.000538
MY711-4	0.25	1.70	1410	64.5	0.99	0.5	1.6	5	12μf/450V	65	5.8	0.000641
MY712-4	0.37	2.43	1410	67.5	0.98	0.44	1.65	7.5	16μf/450V	68	6.9	0.000846
MY713-4	0.55	3.45	1385	70	0.99	0.45	1.47	10.5	20μf/450V	70	8.3	0.001052
MY800-4	0.37	2.38	1420	69	0.98	0.45	1.8	9	16μf/450V	68	8	0.001285
MY801-4	0.55	3.34	1420	73	0.98	0.45	1.78	13	20μf/450V	70	9.5	0.001618
MY802-4	0.75	4.42	1420	74.5	0.99	0.44	1.71	16.5	30μf/450V	70	10.5	0.002061
MY90S-4	1.1	6.30	1420	77.5	0.98	0.35	1.75	24	40μf/450V	73	13.1	0.002500
MY90L-4	1.5	8.55	1420	79.5	0.96	0.33	1.8	36	45μf/450V	75	16.5	0.003240
MY100L1-4	2.2	13.0	1450	79	0.93	0.31	1.8	65	70μf/450V	78	23.4	0.008045
MY100L2-4	3	16.8	1450	81	0.96	0.31	1.8	91	90μf/450V	78	28.7	0.010853
MY631-6	0.09	0.9	900	44.5	0.97	0.38	1.53	2	8μf/450V	63	4.4	0.000550
MY632-6	0.12	1.1	875	47.5	0.98	0.25	1.23	2	11μf/450V	63	5.5	0.000649
MY711-6	0.18	1.5	920	55.5	0.97	0.5	1.5	3.5	11μf/450V	68	6.2	0.000585
MY712-6	0.25	2.0	930	56	0.98	0.45	1.5	5	16μf/450V	68	7.3	0.001151
MY801-6	0.37	2.5	960	66	0.96	0.35	1.6	8.5	20μf/450V	68	9	0.002232
MY802-6	0.55	3.5	955	70.5	0.97	0.35	1.6	12	25μf/450V	70	11.6	0.002903
MY90S-6	0.75	5.0	905	67	0.98	0.35	1.6	13	35μf/450V	70	13.5	0.003523
MY90L-6	1.1	6.6	940	74	0.98	0.35	1.5	25	50μf/450V	70	16.2	0.004957

MOTOR  
PUMP &  
GEARBOX



## Technical Data (at 230V/50Hz)

Model	Power (kW)	Current (A)	Speed (r/min)	Eff (%)	Power Factor (cos φ)	T <sub>st</sub> /T <sub>n</sub> (Times)	T <sub>max</sub> /T <sub>n</sub> (Times)	Starting Current(A)	Run Capacitor (μf/V)	Noise dB(A)	W.L. (Kg)	Inertia (kg·m <sup>2</sup> )
MYT631-2	0.18	1.29	2750	62	0.98	0.7	1.8	4	10μf/450V	70	3.8	0.000141
MYT632-2	0.25	1.71	2750	65	0.98	0.65	1.75	5.5	12μf/450V	70	4.5	0.000168
MYT633-2	0.37	2.39	2740	68	0.99	0.7	1.8	8	16μf/450V	75	5	0.000216
MYT711-2	0.37	2.59	2640	66	0.94	0.7	1.65	8	14μf/450V	75	6	0.000356
MYT712-2	0.55	3.52	2760	71.5	0.95	0.7	1.8	14	20μf/450V	75	7.4	0.000489
MYT801-2	0.75	4.87	2760	69	0.97	0.7	1.8	17.5	25μf/450V	75	9	0.001007
MYT802-2	1.1	6.53	2780	74	0.99	0.7	1.8	25	40μf/450V	78	11.6	0.001238
MYT90S-2	1.5	8.56	2755	77	0.99	0.65	1.8	31	50μf/450V	80	13	0.001665
MYT90L-2	2.2	12.39	2765	78	0.99	0.65	1.8	51	70μf/450V	80	17.8	0.002136
MYT90L2-2	3	16.68	2800	79	0.99	0.48	1.8	85	90μf/450V	83	22.3	0.002686
MYT100L0-2	2.2	12.68	2825	77	0.98	0.55	1.8	13	70μf/450V	80	21	0.004803
MYT100L-2	3	17.11	2765	77	0.99	0.55	1.75	64	90μf/450V	83	23.7	0.005383
MYT561-4	0.06	0.55	1410	49	0.97	0.7	1.8	1.5	4μf/450V	63	3.3	0.000215
MYT562-4	0.09	0.78	1390	51	0.99	0.7	1.65	8	6μf/450V	63	3.6	0.000240
MYT631-4	0.12	0.97	1400	55	0.98	0.7	1.75	2.5	8μf/450V	65	4.4	0.000298
MYT632-4	0.18	1.35	1380	59	0.98	0.6	1.65	3.5	10μf/450V	65	5.1	0.000373
MYT633-4	0.25	1.76	1380	62.5	0.99	0.63	1.57	5	14μf/450V	65	5.4	0.000448
MYT711-4	0.25	1.81	1310	60.5	0.99	0.7	1.55	4.5	14μf/450V	65	6	0.000692
MYT712-4	0.37	2.48	1325	65.5	0.99	0.7	1.52	6.5	20μf/450V	68	7.1	0.000898
MYT800-4	0.37	2.63	1350	63	0.97	0.7	1.7	7.5	16μf/450V	68	8.5	0.001396
MYT801-4	0.55	3.70	1330	66	0.98	0.7	1.57	10.5	25μf/450V	73	10	0.001728
MYT802-4	0.75	4.82	1355	69	0.98	0.67	1.65	16	35μf/450V	73	11.4	0.002393
MYT90S-4	1.1	6.94	1355	72.5	0.95	0.68	1.8	22	40μf/450V	75	14.3	0.002743
MYT90L-4	1.5	9.28	1360	74	0.95	0.68	1.8	32	50μf/450V	78	17.3	0.003483
MYT100L1-4	2.2	12.64	1390	78	0.97	0.48	1.75	49	70μf/450V	80	24.5	0.008665
MYT100L2-4	3	16.57	1380	79.5	0.99	0.45	1.6	61	90μf/450V	80	32	0.010853
MYT711-6	0.18	1.52	930	52	0.99	0.65	1.7	3.5	14μf/450V	68	6.2	0.000585
MYT712-6	0.25	2.12	925	54	0.95	0.58	1.7	5	16μf/450V	68	7.3	0.001151
MYT801-6	0.37	2.63	925	63	0.97	0.67	1.7	7.5	20μf/450V	68	9	0.002232
MYT802-6	0.55	3.71	915	66.5	0.97	0.63	1.7	11	30μf/450V	70	11.6	0.002903
MYT90S-6	0.75	4.93	890	67.5	0.98	0.65	1.5	12	40μf/450V	70	13.5	0.003523
MYT90L-6	1.1	7.15	905	69	0.97	0.55	1.7	21	50μf/450V	70	16.2	0.004957

\* Note: MYT is high starting torque series single phase capacitor-run motors



# TA Series

## Three-Phase Asynchronous Motors Aluminum Housing

### FEATURES

- Energy savings, high efficiency
- High starting torque, lower starting current
- Versatile and easy to modify design adapts to a variety of applications
- Removable feet
- Option of terminal box location (top, left or right)
- Option of IE2, IE3, MEPS High and Premium Efficiency for IEC standards + NEMA EPACT and Premium Efficiency
- Contained total length is the same as or shorter than the current market standard
- Full use of the magnetization properties of cold rolled silicone steel in which the stator laminations are magnetized evenly to reduce temperature rise of the winding

### APPLICATIONS

- Pumps
- Waste water treatment plants
- Air compressors, fans
- Gear reducers and power transmission
- Pulp and paper mills
- Steel mill
- Conveyors, elevators
- "Material handling equipment"
- Agricultural application
- Mining equipment
- Hydraulic equipment



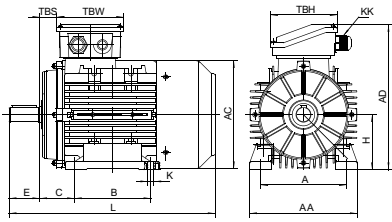

56-160 IM B3

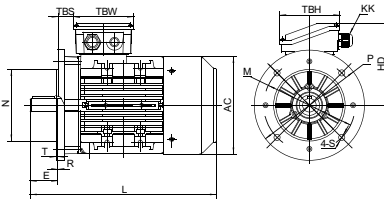

56-160 IM B5

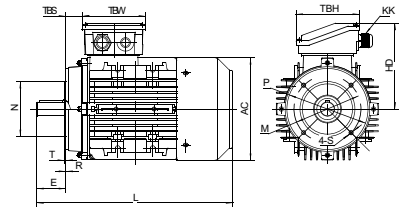

56-160 IM B14

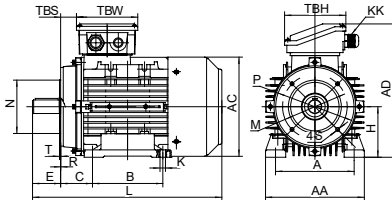

56-160 IM B34

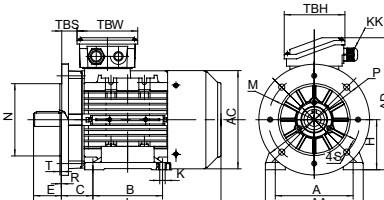

56-160 IM B35

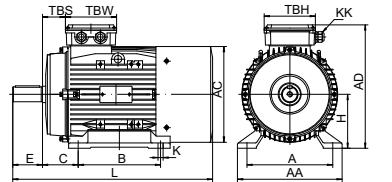
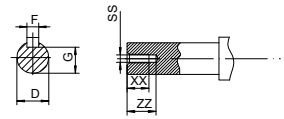

180-200 IM B3

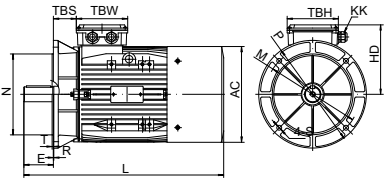

180-200 IM B5

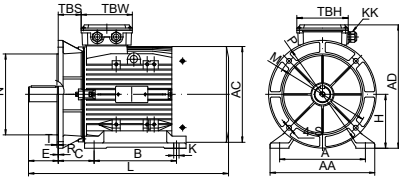

180-200 IM B35

## Overall & Installation Dimensions

FRAME	Foot Mounting				Shaft								General							
	H	A	B	C	D	E	F	G	K	SS	XX	ZZ	AA	AD	HD	AC	L	TBS	TBW	TBH
TA 56	56	90	71	36	Φ9	20	3	7.2	6×9	M4	10	14	112	151	95	Φ110	195	16.5	83	83
TA 63	63	100	80	40	Φ11	23	4	8.5	7×10	M4	10	14	124	172	109	Φ122	217	10	98	98
TA 71	71	112	90	45	Φ14	30	5	11	7×10	M5	12	17	140	189	118	Φ138	245	16	98	98
TA 80	80	125	100	50	Φ19	40	6	15.5	10×15	M6	16	21	160	214	134	Φ157	227/304*	26.5	109	109
TA 90S	90	140	100	56	Φ24	50	8	20	10×15	M8	19	25	176	235	145	Φ177	315/340*	28.5	109	109
TA 90L	90	140	125	56	Φ24	50	8	20	10×15	M8	19	25	176	235	145	Φ177	340/365*	28.5	109	109
TA 100	100	160	140	63	Φ28	60	8	24	12×16	M10	22	30	200	260	160	Φ199	376/411*	32	118	118
TA 112	112	190	140	70	Φ28	60	8	24	12×16	M10	22	30	224	283	171	Φ220	398	33	118	118
TA 132S/M	132	216	140/178	89	Φ38	80	10	33	12×16	M12	28	37	260	323	191	Φ261	460/498	36.5	118	118
TA 160M/L	160	254	210/254	108	Φ42	110	12	37	15×21	M16	36	45	314	391	231	Φ314	616/660	64	148	148
TA 180	180	279	241/279	121	Φ48	110	14	42.5	15×25	M16	36	45	340	440	260	Φ355	730	73	190	190
TA200	200	318	305	133	Φ55	110	16	49	19×29	M20	42	53	390	460	260	Φ355	745	85	190	190

FRAME	KK	B5						B14						B5R						B14B						
		N	M	P	S	T	R	N	M	P	S	T	R	N	M	P	T	S	R	N	M	P	T	S	R	
TA 56	1-M16*1.5	Φ80	Φ100	Φ120	Φ7	3	0	Φ50	Φ65	Φ80	M5	2.5	0													
TA 63	1-M16*1.5	Φ95	Φ115	Φ140	Φ10	3	0	Φ60	Φ75	Φ90	M5	2.5	0													
TA 71	1-M20*1.5	Φ110	Φ130	Φ160	Φ10	3.5	0	Φ70	Φ85	Φ105	M6	2.5	0	Φ95	Φ115	Φ140	3	Φ10	0	Φ95	Φ115	Φ140	3	M8	0	
TA 80	1-M20*1.5	Φ130	Φ165	Φ200	Φ12	3.5	0	Φ80	Φ100	Φ120	M6	3	0	Φ110	Φ130	Φ160	3.5	Φ10	0	Φ110	Φ130	Φ160	3.5	M8	0	
TA 90S/L	1-M20*1.5	Φ130	Φ165	Φ200	Φ12	3.5	0	Φ95	Φ115	Φ140	M8	3	0	Φ110	Φ130	Φ160	3.5	Φ10	0	Φ110	Φ130	Φ160	3.5	M8	0	
TA 100	2-M20*1.5	Φ180	Φ215	Φ250	Φ15	4	0	Φ110	Φ130	Φ160	M8	3.5	0	Φ130	Φ165	Φ200	3.5	Φ12	0	Φ130	Φ165	Φ200	3.5	M10	0	
TA 112	2-M25*1.5	Φ180	Φ215	Φ250	Φ15	4	0	Φ110	Φ130	Φ160	M8	3.5	0	Φ130	Φ165	Φ200	3.5	Φ12	0	Φ130	Φ165	Φ200	3.5	M10	0	
TA 132S/M	2-M25*1.5	Φ230	Φ265	Φ300	Φ15	4	0	Φ130	Φ165	Φ200	M10	3.5	0	Φ180	Φ215	Φ250	4	Φ15	0	Φ180	Φ215	Φ250	4	M12	0	
TA 160M/L	2-M32*1.5	Φ250	Φ300	Φ350	Φ19	5	0	Φ180	Φ215	Φ250	M12	4	0													
TA 180	2-M32*1.5	Φ250	Φ300	Φ350	Φ19	5	0																			
TA200	2-M40*1.5	Φ300	Φ350	Φ400	Φ19	5	0																			



MOTOR  
PUMP &  
GEARBOX



## T3A Series IE3 Efficiency Motors Technical Data (at 50Hz)

Model	Power	Current(A)			Current(A)			Current(A)			Speed (r/min)	Eff.			Power Factor	T <sub>max</sub> /T <sub>n</sub> (Times)	T <sub>max</sub> /T <sub>s</sub> (Times)	T <sub>max</sub> /T <sub>1</sub> (Times)	I <sub>p</sub> /I <sub>n</sub> (Times)	Noise dB(A)	W.T (kg)	Inertia (kg*m <sup>2</sup> )
		220V	380V	660V	230V	400V	690V	240V	415V	720V		100%	75%	50%								
T3A 90L1-4	1.5	6.34	3.66	2.11	6.02	3.48	2.01	5.80	3.35	1.93	1440	85.3	85.3	83.1	0.73	4.1	4.1	3.4	8.1	61	18	0.00468546
T3A 100L1-4	2.2	8.14	4.70	2.71	7.74	4.47	2.58	7.46	4.31	2.49	1450	86.7	87.2	86.2	0.82	2.9	3.5	2.4	8	64	23.9	0.00875401
T3A 100L2-4	3	11.5	6.66	3.85	11.0	6.33	3.65	10.6	6.10	3.52	1450	87.7	88	86.9	0.78	3.3	3.4	2.7	8.1	64	28.3	0.01106275
T3A 112M1-4	4	14.5	8.37	4.83	13.8	7.95	4.59	13.3	7.66	4.42	1450	88.6	88.8	88.2	0.82	3.1	3.7	2.6	8.6	65	33.9	0.01529165
T3A 112M2-4	5.5	20.2	11.7	6.73	19.2	11.1	6.39	18.5	10.7	6.16	1450	89.6	89.9	89.1	0.8	3.8	3.7	2.5	9.1	71	39.1	0.04875837
T3A 132S-4	5.5	19.2	11.1	6.41	18.3	10.5	6.09	17.6	10.2	5.87	1460	89.6	89.8	89.4	0.84	2.3	3.5	1.9	9	71	47.4	0.03446419
T3A 132M1-4	7.5	26.0	15.0	8.66	24.7	14.3	8.23	23.8	13.7	7.93	1460	90.4	90.9	90.3	0.84	2.6	3.4	2.2	8.9	71	57.4	0.04359680
T3A 132M2-4	9.2	32.5	18.8	10.8	30.9	17.8	10.3	29.8	17.2	9.93	1460	90.8	91.3	90.7	0.82	3.2	3.6	2	10	74	60	0.05133916
T3A 132M3-4	11	37.7	21.8	12.6	35.8	20.7	11.9	34.5	19.9	11.5	1460	91.4	92	91.6	0.84	3.5	3.7	2.1	10.5	75	67	0.06037189
T3A 160M-4	11	38.2	22.0	12.7	36.3	20.9	12.1	34.9	20.2	11.6	1470	91.4	91.7	89.8	0.83	2.6	2.8	1.8	7.6	75	89	0.10537280
T3A 160L1-4	15	50.4	29.1	16.8	47.9	27.7	16.0	46.2	26.7	15.4	1470	92.1	92.3	91.3	0.85	3	3	2	9.2	75	110.5	0.13703810
T3A 180M-4	18.5	61.1	35.3	20.4	58.1	33.5	19.4	56.0	32.3	18.7	1470	92.6	92.8	92.1	0.86	2.8	3.3	1.9	8.8	80	130	0.17329310
T3A 180L-4	22	72.4	41.8	24.1	68.8	39.7	22.9	66.3	38.3	22.1	1470	93	93.1	92.3	0.86	3	3.5	2.1	9.3	80	145.4	0.20063720
T3A 200L-4	30	95.8	55.3	32.0	91.1	52.6	30.4	87.8	50.7	29.3	1470	93.6	93.7	92.9	0.88	3.2	3.7	2.1	9.7	83	180	0.26510010
T3A 711-6	0.18	1.20	0.69	0.40	1.14	0.66	0.38	1.09	0.63	0.36	930	63.9	61	53.4	0.62	2.4	2.6	2.3	3.5	52	5.4	0.00079000
T3A 712-6	0.25	1.48	0.85	0.49	1.40	0.81	0.47	1.35	0.78	0.45	920	68.6	67.2	61.2	0.65	2.2	2.5	2.2	3.7	52	6.3	0.00102000
T3A 801-6	0.37	1.95	1.12	0.65	1.85	1.07	0.62	1.78	1.03	0.59	930	73.5	73.8	70.5	0.68	2.2	2.5	2.1	4.1	56	9.3	0.00218934
T3A 802-6	0.55	2.64	1.52	0.88	2.51	1.45	0.84	2.42	1.40	0.81	930	77.2	78.1	75.7	0.71	2.3	2.4	2.1	4.3	56	10.9	0.00293059
T3A 803-6	0.75	3.97	2.29	1.32	3.77	2.18	1.26	3.64	2.10	1.21	935	78.9	78.2	74.4	0.63	2.8	3.1	2.6	4.9	59	12.5	0.00322709
T3A 90S-6	0.75	3.73	2.16	1.24	3.55	2.05	1.18	3.42	1.97	1.14	950	78.9	80.1	78.1	0.67	2.3	2.6	2.1	4.7	59	13.8	0.00406984
T3A 90L-6	1.1	5.33	3.08	1.78	5.07	2.93	1.69	4.88	2.82	1.63	950	81	81.1	78.4	0.67	2.7	2.9	2.5	5.2	59	16.2	0.00548739
T3A 90L2-6	1.5	7.14	4.12	2.38	6.78	3.92	2.26	6.54	3.78	2.18	950	82.5	82.7	80.5	0.67	2.9	3	2.5	5.6	61	21.3	0.00689472
T3A 100L1-6	1.5	6.84	3.95	2.28	6.49	3.75	2.16	6.26	3.61	2.09	955	82.5	83	81.8	0.7	2.4	2.9	2.2	5.5	61	22.1	0.00913729
T3A 100L2-6	2.2	9.54	5.51	3.18	9.06	5.23	3.02	8.73	5.04	2.91	955	84.3	85.1	83.9	0.72	2.5	3	2.2	6.2	64	27.7	0.01272548
T3A 112M1-6	2.2	10.1	5.83	3.37	9.59	5.54	3.20	9.25	5.34	3.08	965	84.3	84.5	83.2	0.68	2	2.5	1.9	5.5	64	27.1	0.01767543
T3A 112M2-6	3	13.4	7.72	4.46	12.7	7.33	4.23	12.2	7.07	4.08	965	85.6	86.2	84.8	0.69	2.5	2.9	1.9	6.3	64	33.1	0.02140041
T3A 132S-6	3	12.5	7.20	4.15	11.8	6.84	3.95	11.4	6.59	3.80	965	85.6	86	85.1	0.74	2	2.7	1.7	6	64	38.6	0.03380429
T3A 132M1-6	4	16.4	9.46	5.46	15.6	8.99	5.19	15.0	8.66	5.00	970	86.8	87.1	86.2	0.74	2.3	3	1.8	6.8	68	47.6	0.04394565
T3A 132M2-6	5.5	23.2	13.4	7.72	22.0	12.7	7.34	21.2	12.2	7.07	975	88	88.3	87.1	0.71	2.9	3.5	2.2	7.4	68	55.7	0.05398713
T3A 132M3-6	7.5	30.8	17.8	10.3	29.2	16.9	9.74	28.2	16.3	9.39	970	89.1	89.6	88.6	0.72	3.3	3.2	2	8.3	68	67.6	0.07072295
T3A 160M-6	7.5	29.1	16.8	9.72	27.7	16.0	9.23	26.7	15.4	8.90	975	89.1	89.5	88.5	0.76	2.2	2.9	1.8	7.3	68	79.6	0.10901170
T3A 160L-6	11	41.1	23.7	13.7	39.0	22.5	13.0	37.6	21.7	12.5	975	90.3	90.8	89.9	0.78	2.7	2.9	1.2	8.4	73	105	0.15484950
T3A 180L-6	15	52.1	30.1	17.4	49.5	28.6	16.5	47.7	27.6	15.9	980	91.2	91	89.8	0.83	2.5	3.3	2.1	8.2	77	125.2	0.27515650
T3A 200L1-6	18.5	67.2	38.8	22.4	63.8	36.9	21.3	61.5	35.5	20.5	980	91.7	91.3	90	0.79	2.5	3.3	2	8.5	80	143	0.33206640
T3A 200L2-6	22	79.5	45.9	26.5	75.5	43.6	25.2	72.8	42.0	24.3	980	92.2	92	90.9	0.79	2.8	3.5	2.2	8.8	80	162	0.38831630

MOTOR  
PUMP &  
GEARBOX



# TC Series

## Three-Phase Asynchronous Motors Cast Iron Housing

### FEATURES

- Energy savings, high efficiency
- High starting torque, lower starting current
- Versatile and easy to modify design adapts to a variety of applications
- Option of integrated or removable feet
- Option of terminal box location (top, left or right) up to and including 280 frames.
- Option of IE2, IE3, MEPS High and Premium Efficiency for IEC standards + NEMA EPACT and Premium Efficiency
- Contained total length is the same as or shorter than the current market standard
- Full use of the magnetization properties of cold rolled silicone steel in which the stator laminations are magnetized evenly to reduce temperature rise of the winding



### APPLICATIONS

- Pumps
- Waste water treatment plants
- Air compressors, fans HVAC
- Gear reducers and power transmission
- Pulp and paper mills
- Steel mill
- Conveyors, elevators
- Should be "Material handling equipment"
- Agricultural application
- Mining equipment
- Hydraulic equipment

MOTOR  
PUMP &  
GEARBOX

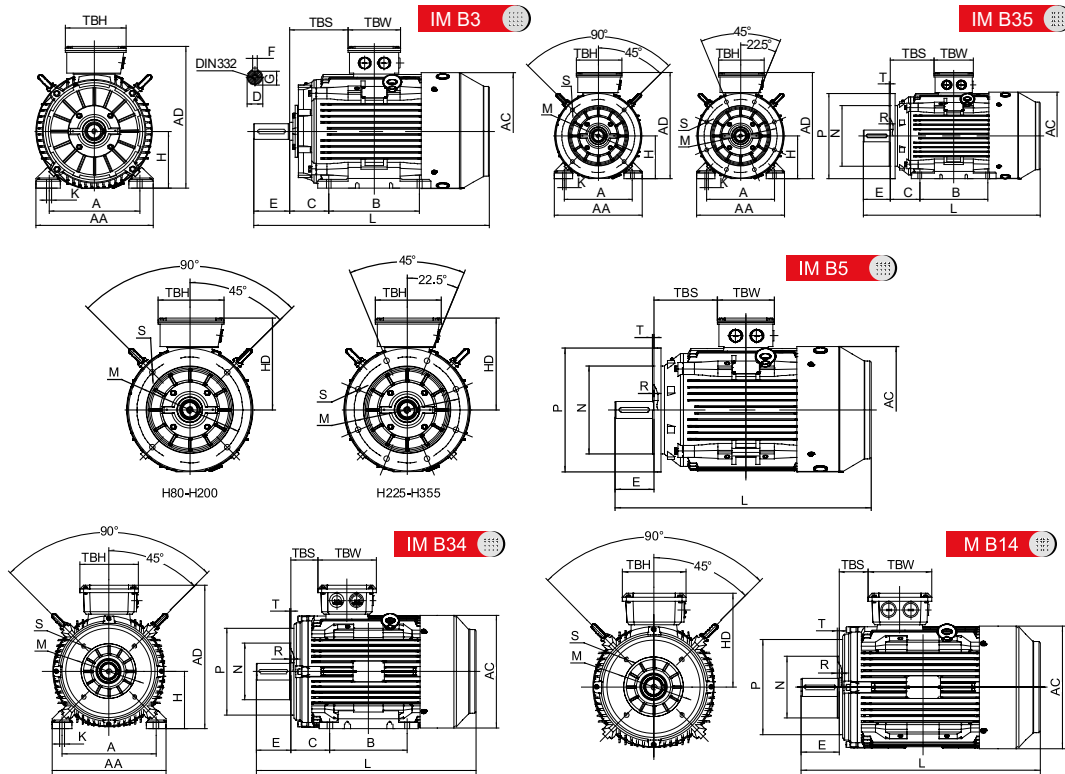

## Overall & Installation Dimensions

Frame	Foot Mounting				Shaft						General						
	H	A	B	C	D	E	F	G	K	AA	AD	HD	AC	L	TBS	TBW	TBH
80	80	125	100	50	φ 19	40	6	15,5	φ 9	154	214	134	φ 158	290	43	114	114
90S/L	90	140	100/125	56	φ 24	50	8	20	φ 10	178	231	141	φ 176	320/345	49/61,5	114	114
100L	100	160	140	63	φ 28	60	8	24	φ 12	203	251	151	φ 199	385	76	114	114
112M	112	190	140	70	φ 28	60	8	24	φ 12	231	292	180	φ 220	405	73	134	134
132S/M	132	216	140/178	89	φ 38	80	10	33	φ 12	263	332	200	φ 259	467/505	61,5	134	134
160M/L	160	254	210/254	108	φ 42	110	12	37	φ 15	316	404	244	φ 313	605/650	91	162	187
180M/L	180	279	241/279	121	φ 48	110	14	42,5	φ 15	354	445	265	φ 360	687/725	160/180	162	187
200L	200	318	305	133	φ 55	110	16	49	φ 19	393	500	300	φ 399	768,5	192	186	233
225S	4,6,8	225	356	286	φ 60	140	18	53	φ 19	440	558	333	φ 459	810	199	186	233
225M	2	225	356	311	φ 55	110	16	49	φ 19	440	558	333	φ 459	805	211,5	186	233
225M	4,6,8	225	356	311	φ 60	140	18	53	φ 19	440	558	333	φ 459	835	211,5	186	233
250M	2	250	406	349	φ 60	140	18	53	φ 24	484	616	366	φ 506	915	233	218	260
250M	4,6,8	250	406	349	φ 65	140	18	58	φ 24	484	616	366	φ 506	915	233	218	260
280S/M	2	280	457	368/419	φ 65	140	18	58	φ 24	560	675	395	φ 559	984/1035	265/277	218/245	260/280
280S/M	4,6,8	280	457	368/419	φ 75	140	20	67,5	φ 24	560	675	395	φ 559	984/1035	265/277	218/245	260/280
315S	2	315	508	406	φ 65	140	18	58	φ 28	628	825	510	φ 680	1205	200	290	350
315S	4,6,8	315	508	406	φ 80	170	22	71	φ 28	628	825	510	φ 680	1235	200	290	350
315M/L	2	315	508	457/508	φ 65	140	18	58	φ 28	628	825	510	φ 680	1355	200	290	350
315M/L	4,6,8	315	508	457/508	φ 80	170	22	71	φ 28	628	825	510	φ 680	1385	200	290	350
355M/L	2	355	610	560/630	φ 75	140	20	67,5	φ 28	740	1010	655	φ 820	1495	140	330	380
355M/L	4,6,8	355	610	560/630	φ 95	170	25	86	φ 28	740	1010	655	φ 820	1525	140	330	380
355M/L	4,6,8	355	610	560/630	φ 100	210	28	90	φ 28	740	1010	655	φ 820	1565	140	330	380

Frame	Bearings		Cable Gland	B5						B14					
	DE	NDE		N	M	P	S	T	R	N	M	P	S	T	R
80		6204	1-M20×1,5	φ 130	φ 165	φ 200	4× φ 12	3,5	0	φ 80	φ 100	φ 120	M6	3	0
90S/L		6205	1-M20×1,5	φ 130	φ 165	φ 200	4× φ 12	3,5	0	95	115	140	M8	3	0
100L		6206	1-M20×1,5	φ 180	φ 215	φ 250	4× φ 15	4	0	110	130	160	M8	3,5	0
112M		6306	2-M25×1,5	φ 180	φ 215	φ 250	4× φ 15	4	0	110	130	160	M8	3,5	0
132S/M		6308	2-M25×1,5	φ 230	φ 265	φ 300	4× φ 15	4	0	130	165	200	M10	3,5	0
160M/L		6309	2-M32×1,5	φ 250	φ 300	φ 350	4× φ 19	5	0	180	215	250	M12	5	0
180M/L		6311	2-M32×1,5	φ 250	φ 300	φ 350	4× φ 19	5	0						
200L		6312	2-M40×1,5	φ 300	φ 350	φ 400	4× φ 19	5	0						
225S/M		6313	2-M50×1,5	φ 350	φ 400	φ 450	8× φ 19	5	0						
250M		6314	2-M50×1,5	φ 450	φ 500	φ 550	8× φ 19	5	0						
280S/M		6316	2-M50×1,5	φ 450	φ 500	φ 550	8× φ 19	5	0						
315S/M/L	2	6317	2-M63×1,5	φ 550	φ 600	φ 660	8× φ 24	6	0						
315S/M/L	4,6,8	NU319								6319					
355M/L	2	6319	2-M63×1,5	φ 680	φ 740	φ 800	8× φ 24	6	0						
355M/L	4,6,8	NU322								6322					



MOTOR  
PUMP &  
GEARBOX

## T3C Series IE3 Efficiency Motors Technical Data (400V/50Hz)

Model	Output (kW)	Rated current (A)	Rotation speed (r/min)	Efficiency 100% load (%)	Efficiency 75% load (%)	Efficiency 50% load (%)	Power factor (Φ)	Rated torque (N.m)	T <sub>st</sub> /T <sub>n</sub> (Times)	T <sub>max</sub> /T <sub>n</sub> (Times)	T <sub>max</sub> /T <sub>s</sub> (Times)	I <sub>st</sub> /I <sub>n</sub> (Times)	Noise (dB)	Net weight (kg)	Moment of inertia (kg·m <sup>2</sup> )
T3C 801-2	0.75	1.68	2880	80.7	81.0	76.2	0.80	2.49	2.5	2.1	2.8	7.5	67	15.20	0.00093
T3C 802-2	1.1	2.40	2880	82.7	83.5	81.6	0.80	3.65	2.5	1.8	2.8	8	67	17.10	0.00128
T3C 90S-2	1.5	3.06	2880	84.2	84.9	84.0	0.84	4.97	2.5	1.8	2.8	8.5	72	21.5	0.00224
T3C 90L-2	2.2	4.45	2880	85.9	86.4	84.7	0.83	7.30	2.5	1.8	2.8	8.6	72	24.6	0.00279
T3C 100L-2	3	5.65	2900	87.1	88.5	86.8	0.88	9.88	2.5	2.0	2.8	9.5	76	35.5	0.00496
T3C 112M-2	4	7.28	2910	88.1	88.5	87.1	0.90	13.13	2.5	2.0	2.8	10.5	77	44.5	0.00744
T3C 132S1-2	5.5	10.11	2910	89.2	90.2	88.6	0.88	18.05	2.5	2.0	3.0	10	80	63.2	0.01468
T3C 132S2-2	7.5	13.50	2920	90.1	90.8	89.3	0.89	24.53	2.5	1.5	3.0	10	80	70.2	0.01903
T3C 132M1-2	9.2	16.47	2920	90.6	91.2	89.5	0.89	30.09	2.5	1.5	3.0	10	80	76.8	0.02048
T3C 160M1-2	11	19.34	2930	91.2	93.8	93.0	0.90	35.85	2.5	1.4	3.0	9.5	86	118.0	0.05178
T3C 160M2-2	15	26.18	2940	91.9	93.1	92.9	0.90	48.72	2.5	1.4	3.0	10	86	128.0	0.06206
T3C 160L-2	18.5	31.76	2940	92.4	93.5	93.3	0.91	60.09	2.5	1.4	3.0	9.5	86	144.00	0.07669
T3C 180M-2	22	38.5	2945	92.7	94.1	93.6	0.89	71.34	2.5	1.4	3.0	9	89	183.40	0.09665
T3C 200L1-2	30	52.1	2945	93.3	93.8	93.2	0.89	97.3	2.5	1.5	2.5	8.5	92	247.00	0.17351
T3C 200L2-2	37	64.0	2945	93.7	94.4	94.2	0.89	120.0	2.5	1.5	2.5	8.5	92	268.00	0.20008
T3C 225M-2	45	75.9	2950	94	94.6	94.1	0.91	145.7	2.5	1.4	2.5	8.5	92	369.00	0.34366
T3C 250M-2	55	93.5	2960	94.3	94.5	93.1	0.90	177.4	2.5	1.4	2.6	10	93	428.00	0.44434
T3C 280S-2	75	125.6	2960	94.7	94.9	93.7	0.91	242.0	2.5	1.8	2.6	10	94	587.30	0.82911
T3C 280M-2	90	150.3	2960	95	95.2	94.3	0.91	290.4	2.5	1.8	2.6	10	94	655.00	0.98168
T3C 315S-2	110	185.3	2960	95.2	95.5	94.6	0.90	354.9	2.0	1.4	2.3	7	96	980.00	1.70352
T3C 315M-2	132	221.9	2960	95.4	95.5	94.7	0.90	425.9	2.0	1.4	2.3	7	96	1100.00	1.93860
T3C 315L1-2	160	267.8	2960	95.8	95.8	94.5	0.90	516.2	2.0	1.4	2.3	7	99	1155.00	2.19758
T3C 315L2-2	200	334.8	2960	95.8	96.0	94.7	0.90	645.3	2.0	1.4	2.3	7	99	1260.00	2.55368
T3C 355M1-2	220	394.6	2960	95.8	96.2	94.8	0.84	709.8	2.0	1.5	2.3	6.5	103	1590.00	2.95585
T3C 355M2-2	250	448.4	2960	95.8	96.2	94.8	0.84	806.6	2.0	1.5	2.3	6.5	103	1650.00	3.14272
T3C 355L1-2	280	502.2	2960	95.8	96.2	94.8	0.84	903.4	2.0	1.5	2.3	6.5	103	1715.00	3.47911
T3C 355L2-2	315	558.3	2960	95.8	96.2	94.8	0.85	1016.3	2.0	1.5	2.3	6.5	103	1780.00	3.85287
T3C 802-4	0.75	1.90	1420	82.5	82.8	80.6	0.69	5.04	2.8	2.2	2.8	6.3	58	18.20	0.00155
T3C 90S-4	1.1	2.62	1430	84.1	84.6	83.2	0.72	7.35	2.8	2.2	2.8	6.8	61	23.00	0.00372
T3C 90L-4	1.5	3.63	1430	85.3	86.1	85.2	0.70	10.02	2.8	2.2	3.0	7.3	61	26.30	0.00469
T3C 100L1-4	2.2	4.52	1430	86.7	87.8	85.2	0.81	14.69	2.8	2.2	3.0	8	64	35.50	0.00922
T3C 100L2-4	3	6.33	1435	87.7	88.0	85.9	0.78	19.97	2.5	2.2	3.0	8.2	64	38.50	0.01195
T3C 112M-4	4	7.95	1440	88.6	88.9	87.5	0.82	26.53	2.5	2.2	3.0	8.6	65	47.00	0.01545
T3C 132S-4	5.5	10.67	1440	89.6	90.9	88.9	0.83	36.48	2.5	1.8	3.0	9	71	68.30	0.03397
T3C 132M-4	7.5	14.09	1440	90.4	91.3	91.2	0.85	49.74	2.5	1.6	3.0	9	71	79.00	0.04412
T3C 132M2-4	9.2	17.19	1440	90.9	91.8	90.5	0.85	61.01	2.5	1.6	3.0	9	71	87.50	0.04700
T3C 160M-4	11	20.68	1450	91.4	92.2	91.7	0.84	72.45	2.5	1.3	3.0	10	75	127.00	0.10355
T3C 160L-4	15	27.33	1450	92.1	92.9	92.2	0.86	98.8	2.5	1.3	2.8	8.5	75	160.00	0.13750
T3C 180M-4	18.5	33.5	1460	92.6	93.6	93.0	0.86	121.0	2.5	1.8	3.0	9	76	169.40	0.15530
T3C 180L-4	22	39.2	1460	93	93.7	92.9	0.87	143.9	2.5	1.8	3.0	10	76	196.00	0.19433

MOTOR  
PUMP &  
GEARBOX



## T3C Series IE3 Efficiency Motors Technical Data (400V/50Hz)

Model	Output (kW)	Rated current (A)	Rotation speed (r/min)	Efficiency 100% load (%)	Efficiency 75% load (%)	Efficiency 50% load (%)	Power factor (Φ)	Rated torque (N.m)	T <sub>st</sub> /T <sub>n</sub> (Times)	T <sub>max</sub> /T <sub>n</sub> (Times)	T <sub>max</sub> /T <sub>s</sub> (Times)	I <sub>st</sub> /I <sub>n</sub> (Times)	Noise (dB)	Net weight (kg)	Moment of inertia (kg·m <sup>2</sup> )
T3C 200L-4	30	57.1	1470	93.6	93.7	93.2	0.81	194.9	2.5	1.8	2.8	9	79	252.00	0.29441
T3C 225S-4	37	65.4	1470	93.9	95.2	94.3	0.87	240.4	2.5	1.4	2.5	9.2	81	324.50	0.57838
T3C 225M-4	45	79.3	1470	94.2	95.2	94.5	0.87	292.3	2.5	1.5	2.5	9	81	352.90	0.65309
T3C 250M-4	55	95.4	1470	94.6	95.2	94.5	0.88	357.3	2.5	1.8	2.5	8.5	83	427.40	0.76504
T3C 280S-4	75	131.0	1480	95	95.1	94.8	0.87	484.0	2.5	1.8	2.8	10	86	673.30	1.99603
T3C 280M-4	90	160.5	1480	95.2	95.1	95.0	0.85	580.7	2.5	1.8	2.8	10	86	692.00	2.18345
T3C 315S-4	110	189.1	1480	95.4	95.7	94.6	0.88	709.8	2.2	1.5	2.6	9	93	1027.00	3.71808
T3C 315M-4	132	226.5	1480	95.6	95.8	95.0	0.88	851.8	2.2	1.5	2.6	9	93	1155.00	4.29667
T3C 315L1-4	160	273.9	1480	95.8	96.0	95.1	0.88	1032.4	2.2	1.5	2.6	9	97	1240.00	5.10990
T3C 315L2-4	200	337.9	1480	96	96.2	95.3	0.89	1290.5	2.2	1.5	2.6	9	97	1400.00	6.17334
T3C 355M1-4	220	371.7	1480	96	96.2	95.3	0.89	1419.6	2.0	1.3	2.3	8	101	1560.00	7.04227
T3C 355M2-4	250	422.3	1480	96	96.3	95.4	0.89	1613.2	2.0	1.3	2.3	8	101	1600.00	7.63820
T3C 355L1-4	280	473.0	1480	96	96.4	95.4	0.89	1806.8	2.0	1.3	2.3	8	101	1650.00	8.31927
T3C 355L2-4	315	532.1	1480	96	96.3	95.5	0.89	2032.6	2.0	1.3	2.3	8	101	1700.00	9.34080
T3C 90S-6	0.75	2.05	935	78.9	79.6	77.2	0.67	7.66	2.0	1.8	2.2	5	57	21.50	0.00435
T3C 90L-6	1.1	2.97	940	81	81.5	80.2	0.66	11.18	2.3	1.8	2.2	5.2	57	25.50	0.00611
T3C 100L-6	1.5	3.55	940	82.5	83.0	81.6	0.74	15.24	2.0	1.7	2.2	5.2	61	33.50	0.00972
T3C 112M-6	2.2	5.38	940	84.3	85.0	83.2	0.70	22.35	2.0	1.8	2.2	6.2	65	40.00	0.01637
T3C 132S-6	3	6.84	940	85.6	86.1	84.5	0.74	30.48	2.0	1.7	2.2	6	69	59.00	0.03223
T3C 132M1-6	4	8.99	950	86.8	87.6	85.2	0.74	40.21	2.0	1.6	2.5	7	69	75.50	0.04338
T3C 132M2-6	5.5	12.71	950	88	88.8	86.9	0.71	55.29	2.3	1.8	2.5	7.5	69	76.30	0.05443
T3C 160M-6	7.5	16.2	960	89.1	90.3	88.0	0.75	74.6	2.3	1.4	2.8	7.5	73	112.00	0.08726
T3C 160L-6	11	23.1	960	90.3	91.2	88.5	0.76	109.4	2.5	1.4	2.8	8.5	73	134.00	0.13544
T3C 180L-6	15	30.1	960	91.2	92.0	90.3	0.79	149.2	2.5	1.4	2.8	8	73	184.50	0.27973
T3C 200L1-6	18.5	36.4	970	91.7	92.3	90.6	0.80	182.1	2.5	1.4	2.8	9.5	76	231.00	0.38345
T3C 200L2-6	22	42.5	970	92.2	93.0	91.3	0.81	216.6	2.5	1.5	2.8	10	76	249.00	0.44941
T3C 225M-6	30	53.0	975	92.9	93.8	90.9	0.88	293.8	1.8	1.5	2.2	7	76	339.00	0.67058
T3C 250M-6	37	67.3	975	93.3	94.0	91.8	0.85	362.4	1.8	1.3	2.0	7	78	399.40	0.99243
T3C 280S-6	45	83.5	980	93.7	94.6	92.7	0.83	438.5	2.5	1.8	2.8	10	80	551.00	2.20274
T3C 280M1-6	55	99.3	980	94.1	95.0	93.4	0.85	536.0	2.5	1.8	2.8	10	80	624.30	2.57302
T3C 315S-6	75	139.6	980	94.6	94.8	93.2	0.82	730.9	2.0	1.3	2.3	7.5	85	860.00	3.80317
T3C 315M-6	90	166.9	980	94.9	95	93.4	0.82	877.0	2.0	1.3	2.3	7.5	85	970.00	4.45274
T3C 315L1-6	110	203.6	980	95.1	95.4	94	0.82	1071.9	2.0	1.3	2.3	7.5	85	1070.00	5.53956
T3C 315L2-6	132	243.6	980	95.4	95.7	94.2	0.82	1286.3	2.0	1.3	2.3	7.5	85	1196.00	6.62638
T3C 355M1-6	160	294.6	980	95.6	95.8	94.3	0.82	1559.2	2.0	1.3	2.3	7.5	92	1537.00	8.97637
T3C 355M2-6	200	367.5	980	95.8	95.8	94.3	0.82	1949.0	2.0	1.3	2.3	7.5	92	1720.00	11.00175
T3C 355L1-6	220	404.2	980	95.8	96	94.2	0.82	2143.9	2.0	1.3	2.3	7.5	92	1800.00	11.64134
T3C 355L-6	250	459.3	980	95.8	96	94.3	0.82	2436.2	2.0	1.3	2.3	7.5	92	1880.00	13.56011

MOTOR  
PUMP &  
GEARBOX







# Large Frame LV Motors



**Total Engineering Commitment**

- Ex stock up to 630kW in 2 and 4 pole in IEC 400 Frame
- Ex stock up to 500kW in 2 and 4 pole in compact 355X frame
- WIMES compliant
- IE3 high efficiency
- PTC150°C in winding
- PT100's in winding and bearing
- 1 x 110v & 1 x 230v space heaters
- VFD ready with insulated bearing/NDE shield
- Epoxy paint finish

## Critical Dimensions Overview:

Frame	Power Ratings	Poles	Shaft Comparison						
			D Shaft Dia	E Shaft Length	F Key Width	G Dia To Keyway	DH Centre Hole	L Length Incl. Shaft	Length Without Shaft
355X	400kW/450kW/500kW	2	75	140	20	67.5	M20	1880	1740
355X	400kW/450kW/500kW	4	100	210	28	90	M24	1910	1700
355LY	355kW	2	80	170	22	71	M24	1526	1356
355LY	355kW	4	100	210	28	90	M24	1556	1346
400	400kW/500kW/630kW	2	80	170	22	71	M24	1820	1650
400	400kW/500kW/630kW	4	110	210	28	100	M24	1920	1710

Foot Fixing Comparison				
A	C	B	B1	B2
Fixing Holes Across	Shaft Shoulder To First Fixing	Front To Rear 1st Fixing	Front To Rear 2nd Fixing	Front To Rear 3rd Fixing
630	254	630	710	800
630	254	630	710	800
610	254	560	630	-
610	254	560	630	-
686	280	630	710	-
686	280	630	710	-





# Introducing the TEC Gearbox Range

"With the right partner the battle is already won"

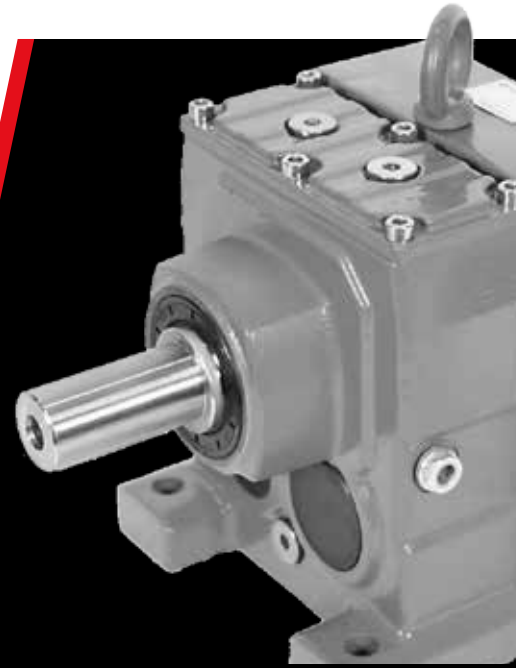

## The Gearbox Range with Industry in mind

The newly developed TEC Gearbox range is the product of market feedback designed with availability and ease of use in mind.

A hard-wearing product line dimensionally interchangeable with the European standard.

MOTOR  
PUMP &  
GEARBOX

### TCNDK



**TEC Worm Gearboxes**

Ratio: 5-100/1  
Torque: Up to 1520nm  
Hollow Bore: 11-60mm  
Features: Alternative Bore, Solid Input, Double Reduction, Flanges, Shafts, Torque Arms

### WKA



**TEC Bevel Helical Gearboxes**

Ratio: 7-250/1  
Torque: Up to 22,400nm  
Hollow Bore: 30-160mm  
Features: IEC Standard Input Flange, Alternative Bore, Flanges, Shafts, Torque Brackets

### WR/WRF

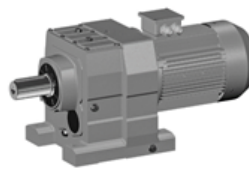

**TEC Coaxial Gearboxes**

Ratio: 1.5-250/1  
Torque: Up to 22,400nm  
Output Shaft: 20-120mm  
Features: IEC Standard Input Flange, B5 Output Flange, Alternative Shaft Sizes.

### WAH

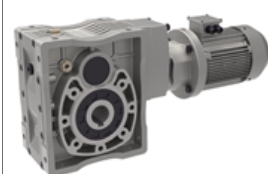

**TEC Hypoid Helical Gearboxes**

Ratio: 7-300/1  
Torque: Up to 500nm  
Hollow Bore: 20-38mm  
Features: Alternative Bores, 2/3 Stage Reduction, Flanges, Shafts, Torque Arms





# TECDrive Inverter Range

## Easy to Use General Purpose Drive

Focused on ease of use, TECDrive provides unrivalled simplicity of installation, connection and commissioning, allowing the user to benefit from precise motor control and energy savings within minutes.

**IP20**

**Up to 37kW**

- Easy to use
- Compact & robust

**IP66**

**Up to 22kW**

- Outdoor rated
- Dust-tight
- Washdown ready
- Switched option available as seen below.





**Total Engineering Commitment**

TEC's extensive product range includes:

	TECA/TA Aluminium Motors 56-200 Frame
	TPC and TCC 1PH Aluminium Motors 56-112 Frame (including 3.7kW!)
	Elprom Zone 1 Exd Motors 63-180 Frame stocked
	TCNDK Worm Boxes Size 30-150
	Official UK Varvel Distributor
	TEC DC motors

	ECOL Cast Iron 80-355 Frame
	TECA BM Brake Motors 71-200 Frame
	TEC Zone 2 EXNA and Zone 22 EXTD 56-315 Frame
	Lightweight, High Efficiency Hypoid Gear Units
	TEC Drive General Purpose Inverter Range
	B48 and B56 Motors

MOTOR  
PUMP &  
GEARBOX

## WIMES Compliant



All stock motors meet WIMES standards and are inverter ready

## Need a Special Paint Finish?



TEC can paint motors up to C5M - ISO12994 upon request at our in-house painting booth

## MV/HV Motors up to 8 MW



TEC also offers medium & high voltage motors up to 8MW and in voltages 3.3kV, 6.6kV, 10kV and 13.8kV



[www.iadaltd.co.uk](http://www.iadaltd.co.uk)

24/7, 365 - SERVICE THAT NEVER STOPS



### VF W series worm gearmotors

Torque range 13 ... 7,100 Nm  
Mechanical rating 0.04 ... 75kW  
Gear ratios 7 ... 10000



### C series in-line helical gearmotors

Torque range 45 ... 12,000 Nm  
Mechanical rating 0.08 ... 213kW  
Gear ratios 2,6 ... 1481



### A series helical bevel gearmotors

Torque range 100 ... 14,000 Nm  
Mechanical rating 0.22 ... 150kW  
Gear ratios 5,4 ... 1715



### 300 series planetary gearmotors

Torque range 1,000 ... 1,100,000 Nm  
Mechanical rating up to 450 kW  
Gear ratios 3,4 ... 5000



### S series single reduction helical gearmotors

Torque range 21 ... 200 Nm  
Mechanical rating 0.12 ... 11,6 kW  
Gear ratios 1,4 ... 13,1



### TA series shaft mounted speed reducers

Torque range 150 ... 16,000 Nm  
Mechanical rating 1,1 ... 156 kW  
Gear ratios 5 ... 31,5

MOTOR  
PUMP &  
GEARBOX



 **Bonfiglioli**  
*We engineer dreams*

Our philosophy has always been to keep things simple. Why over complicate things looking for a magic formula. In today's market stocking complete geared motors is no longer the solution. To ensure a fast reliable service and short lead times local assembly is the way forward, achieved by investing in build centres across the world.

Our formula for success is simple...

**Local assembly = fast reliable delivery = less downtime**

MOTOR  
PUMP &  
GEARBOX



### RAN series bevel gearboxes

Torque range 3 ... 3,000 Nm  
Mechanical rating 0.15 ... 91 kW  
Gear ratios 1 ... 7,4



### F series shaft mounted gearmotors

Torque range 140 ... 14,000 Nm  
Mechanical rating 0.17 ... 125 kW  
Gear ratios 6,4 ... 2099



### HDO series bevel helical gear units (Heavy Duty)

Torque range 25,650 ... 194,050 Nm  
Gear ratios 5,6 ... 400



### HDP series parallel shaft gear units (Heavy Duty)

Torque range 5,000 ... 194,050 Nm  
Gear ratios 7,1 ... 500



### BN series AC motors & brake motors

kW rating 0.06 ... 30 kW  
Frame sizes 56A ... 200L  
Compliance 2006/95/EC (LVD) & 2004/108/EC (EMC)



### BX series IE3 premium efficiency AC motors

kW rating 0.75 ... 22 kW  
Frame sizes 80B ... 180L  
Compliance IEC 60034-30:2008(IE), 640/2009/EC 2006/95/EC (LVD) & 2004/108/EC (EMC)



MOTOR  
PUMP &  
GEARBOX

**HDO Series**  
**The new generation**



Historically Bonfiglioli has always been well known in the market for high quality worm gearboxes and small to medium power geared motors. Much has changed since 1956 with significant investment in the heavy duty gearbox range putting us firmly on the map for this sector.

The range now offers output torque ratings up to 1.25 million Nm with higher ratings being developed.

**Demanding applications? Don't compromise on quality.**



# Fluid Circulation Specialists

Industry Leading Sales, Manufacturing & Service for the UK Pump Industry

Trusted by the Best



## Pump Sourcing & Distribution

With access to in excess of £3m stock holding within the UK – we are perfectly placed to cater for all your pumping needs.

With the teams expansive product knowledge, we know which products to advise on to suit various applications enabling quick delivery timeframes.

From circulators to submersibles and everything in-between – We can get it all.





## System Commissions

Increasingly complex pump systems require precise set up to ensure maximum efficiency and optimum performance.

We don't just deliver product to site and leave it there – We also offer the service of either working alongside your engineers to install or fully offer the commissioning of products to your requirements.

From single pump, to bespoke booster and complete packaged plantroom commissioning; We can offer it all.

## Product Servicing

Some products make commercial sense to maintain for longer periods of time through planned/preventative maintenance.

We can offer routine maintenance contracts on an annual or bi-annual basis to suit customer requirements.

Where others may struggle with less widely used pumps – particularly industrial pumps; this is where our knowledge base really makes our engineers stand out over and above the competition.



MOTOR  
PUMP &  
GEARBOX



## Booster Sets

Covering premium booster sets, combined booster and tank sets – Along with the Trebles Eco-Boost and Eco-Boost+ ranges.

These units are available in single, twin and multiple pump arrangements.

We can offer custom made or bespoke booster sets to suit our customer's specific needs. These can include external applications where equipment is enclosed within a weatherproof kiosk.

## Centrifugal Pumps

Manufactured as standard with cast iron or stainless steel pump body. Suitable for pumping hot and cold, moderately aggressive liquids.



### Single Stage Pumps

Manufactured as standard with cast iron or stainless steel pump body. Suitable for pumping hot and cold, moderately aggressive liquids.

**Available:** Close-coupled with special motor shaft extension, stub shaft and standard motor or with flexible coupling, adapter, base and standard motor in compliance with EN 733 – DIN 24255.



### Multistage Pumps

Using multiple impellers on a common shaft to delivery high pressure, their corrosion resistant liquid-ends and heavy-duty drive-ends are essential features in continuous duty applications.

**Available:** In vertical and horizontal for boiler feed, carwash, washdown, pressure cleaning, reverse osmosis, chemical and oil processing.



### Circulator Pumps

The most common heating pumps are these small (generally under 2kw), single phase, high efficiency circulators.

**Available:** In single or twin head versions.



### Inline Pumps

For larger heating and cooling application as well as process pumps, these inline designs can be single or three phase powered, fixed speed or inverter driven.

**Available:** In single or twin pump versions.



### Self-Priming Pumps

Ideal for transporting liquids containing solids in suspension. Suited for applications where the main feature is the difficulty in priming and are used across industry, construction and emergency.

**Available:** In cast iron, marine bronze or stainless steel.



### Submersible Pumps

For use in markets ranging from water and wastewater treatment, raw water supply, abrasive or contaminated industrial processes, mining and irrigation.

**Available:** As a stand-alone pump, with or without integral level control, or as an easy install packaged pumping station ensuring minimal on-site work.

MOTOR  
PUMP &  
GEARBOX

# Positive Displacement Pumps

Self-priming by design. Suitable for handling viscous products which may also contain solids.



## Air Operated Pumps

Air Operated Diaphragm Pumps are easy to use and maintain, have infinitely variable flow control, can suction lift up to 8m, run dry and operate against closed valve without damage.

**Available:** In a variety of both metal and plastic constructions.



## Progressive Cavity

Ideal for handling slurries, viscous and shear sensitive products. Multi-stage pumps are available for high pressure applications or where accurate dosing is required.

**Available:** In a variety of metals with a huge array of stator materials to suit any application.



## Gear Pumps

Used in industrial plants for pumping liquids of any viscosity without solids in suspension: Chemicals and petroleum products, soaps and detergents, adhesives, paint and ink, high temperature liquids and chocolate.

**Available:** In external and internal gear options.



## Screw Pumps

They can handle virtually any non-homogenous fluid, regardless of viscosity, lubricity or abrasiveness e.g. seawater, bitumen, molasses, lime, acid, caustic solution or hydrocarbon.

**Available:** In high pressure, high capacity, compact and hygienic versions.



## Flexible Impeller Pumps

Reversible pump offers smooth, low pulsating, low shear flow. Stainless steel and bronze casings are available for hygienic and marine applications.

**Available:** Impellers are produced in a variety of materials, (e.g. Natural Rubber, Neoprene, Nitrile and EPDM) making them compatible with a range of fluids.



## Peristaltic Pumps

Hose pumps are seal-less, can dry run without damage and self-prime up to 9.8m. Used widely for pumping minerals, ceramics, chemicals and inks/dyes at pressures up to 15 bar.

**Available:** As a close-coupled unit, constructed in Aluminium or Cast Iron and with a wide variety of hose materials suitable for any application.

## Specialist Pumps

Available in a variety of configurations, materials and finishes appropriate for a huge range of specialist applications.



### Dosing Pumps

These are used for precise dosing of fluids with highly varied viscosities, most of which are chemically aggressive and toxic, and some of which are actually abrasive or emit gasses.

**Available:** In solenoid, motor and stepper motor driven, diaphragm and piston construction.



### Drum Pumps

Drum and container pumps are constructed to assure safety and economy when transferring neutral, aggressive and flammable liquids from different-sized containers. Used for pumping aqueous and light viscous liquids.

**Available:** In a variety of standard materials and stem lengths.



### Hygienic Pumps

Designed to reduce the build-up of bacteria by minimising crevices and dead areas. Consideration is paid to the ease with which the pump can be disassembled for manual cleaning.

- Centrifugal,
- Self-priming
- Cleaning-in-place



### Rotary Lobe Pumps

Hygienic – approved to relevant standards, offering gentle pumping action to suit viscous, delicate and particle-laden liquids. Easy to clean, easy to maintain.

**Available:** In AISI316 stainless steel construction.



### ATEX Pumps

For hazardous areas, we can provide ATEX pumps and safety devices.

If you have specific flammable gasses or dust present in the atmosphere and temperature limit requirements within the pump installation envelope, we can provide you with a solution.



### Packages

Off the shelf or bespoke, automatic packaged sets, designed and built to the highest standards.

**Available:** In fixed or trolley mounted configuration, fixed or variable speed, complete with pipework, valves, control panel and flow / pressure / temperature sensors.

MOTOR  
PUMP &  
GEARBOX

Our pump brands we supply:



MOTOR  
PUMP &  
GEARBOX

# Compressed Air System Guide

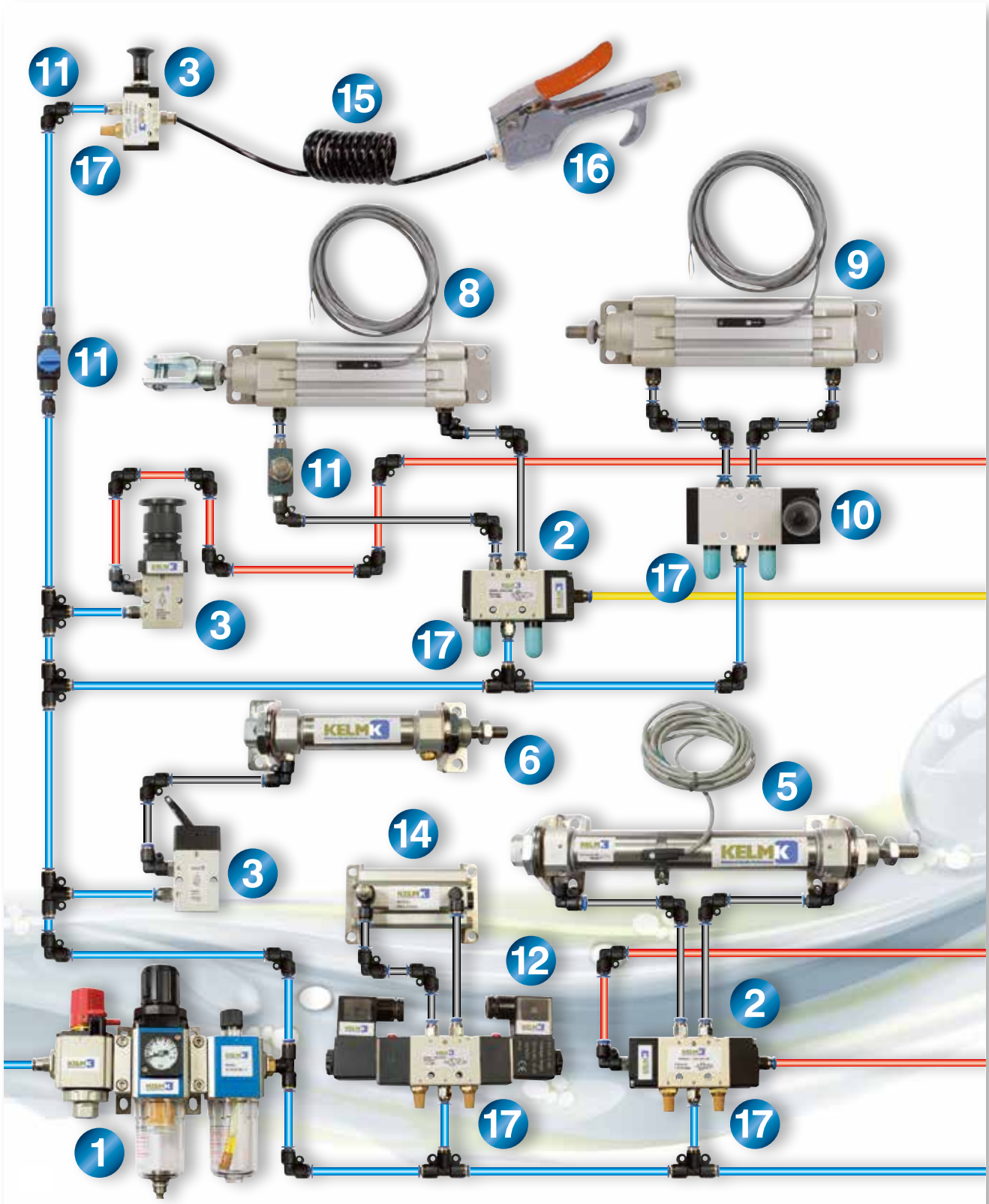

Please refer to our Fluid Power Catalogue for more information



# Compressed Air System Guide

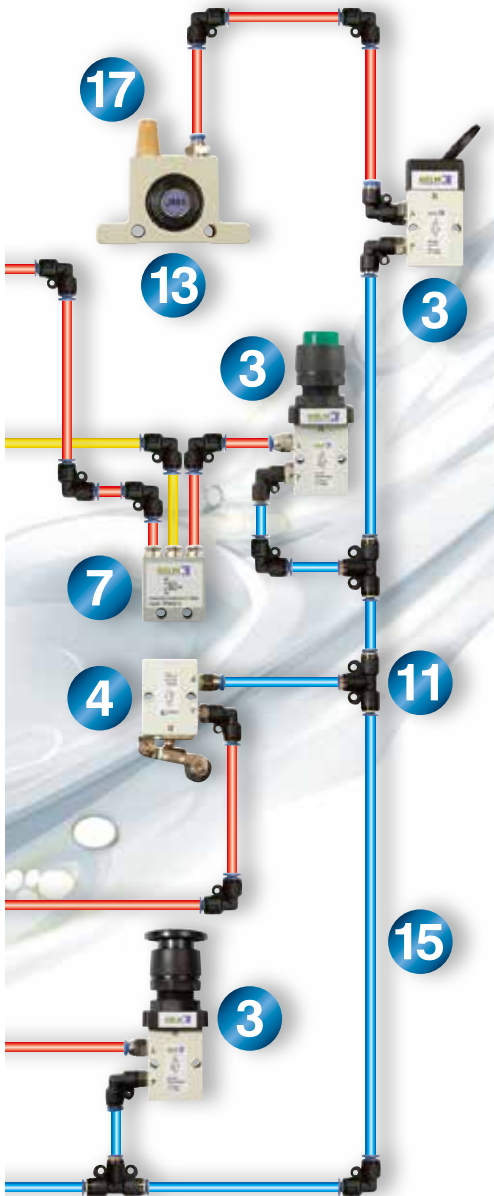

- 1. Air Preparation**  
1/8" up to 1" – Filters, Regulators and Lubricators
- 2. Pilot Operated Valves**  
1/8", 1/4", 3/8" and 1/2" - 3/2, 5/2 and 5/3 Valves
- 3. Manual Operated Valves**  
M5, 1/8", 1/4", 3/8", 1/2" and 3/4" -  
3/2, 4/2, 4/3, 5/2 and 5/3 Valves
- 4. Mechanical Operated Valves**  
M5, 1/8" and 1/4" - 3/2
- 5. ISO 6432 Mini Cylinders**  
Double Acting Magnetic, in Bore Sizes 8mm to 40mm  
Mounting and Reed Switch to suit
- 6. ISO 6432 Mini Cylinders**  
Single Acting Magnetic, in Bore Sizes 8mm to 40mm  
Mounting and Reed Switch to suit
- 7. Logic and Specialist Valves**  
Not, And, Yes, Oscillating, Impulse
- 8. Gen 1 ISO 15552 (Formerly ISO 6431/VDMA 24562)  
Double Acting Magnetic Cylinders, Chrome Plated Carbon  
Steel Piston Rod**  
In Bore Sizes 32mm to 125mm  
Profile barrel with concealed tie rods.  
Switches can be mounted flush with profile barrel.  
Mounting and Reed Switch to suit
- 9. Gen 2 ISO 15552 (Formerly ISO 6431/VDMA 24562)  
Double Acting Magnetic Cylinders, Stainless Steel Piston Rod**  
In Bore Sizes 32mm to 125mm  
Profile barrel with concealed tie rods.  
Switches can be mounted flush with profile barrel.  
Mounting and Reed Switch to suit
- 10. Manual Lever/Lever, Controlled Valves**  
M5, 1/8", 1/4" and 3/8" Valves  
3/2, 5/2 and 5/3 Valves
- 11. Plastic & Metal Push-in Fittings & Flow Restrictors**  
4mm O.D. up to 12mm O.D.
- 12. Solenoid Operated Valves**  
Single Solenoid and Double Solenoid Valves -  
M5, 1/8", 1/4", 3/8" and 1/2" - 3/2, 5/2 and 5/3 Valves
- 13. Pneumatic Vibrators**  
1/4" and 3/8" - Ball and Turbine
- 14. Compact Magnetic Cylinder**  
Double Acting Magnetic in Bore Sizes 12mm to 100mm  
Mounting and Reed Switch to suit
- 15. Spring Coils and Tubing**  
Nylon and Polyurethane
- 16. Blow Guns**  
Metal
- 17. Silencers**  
Plastic, Sintered Bronze and Stainless Steel

Please refer to our Fluid Power Catalogue for more information





# PLASTIC PUSH-IN FITTINGS

## One Touch Emergency Fittings Kits

Convenient, compact boxes containing a selection of popular KELM™ one touch plastic push-in fittings along with handy tube cutter.

Available in three sizes: 6mm, 8mm and 10mm.

Can be used with nylon 6, 11, 12, and polyurethane (ester and ether).

**Working Temperature:**  
Brass: 0°C to +60°C  
Acetal: 0°C to +60°C  
(dependent upon tubing specification)



**Maximum Working Pressure:**  
10 bar (150 psi)  
**Negative Pressure:**  
-750mm Hg (10 Torr)  
(dependent upon tubing specification)

**Media:**  
Air and vacuum only.

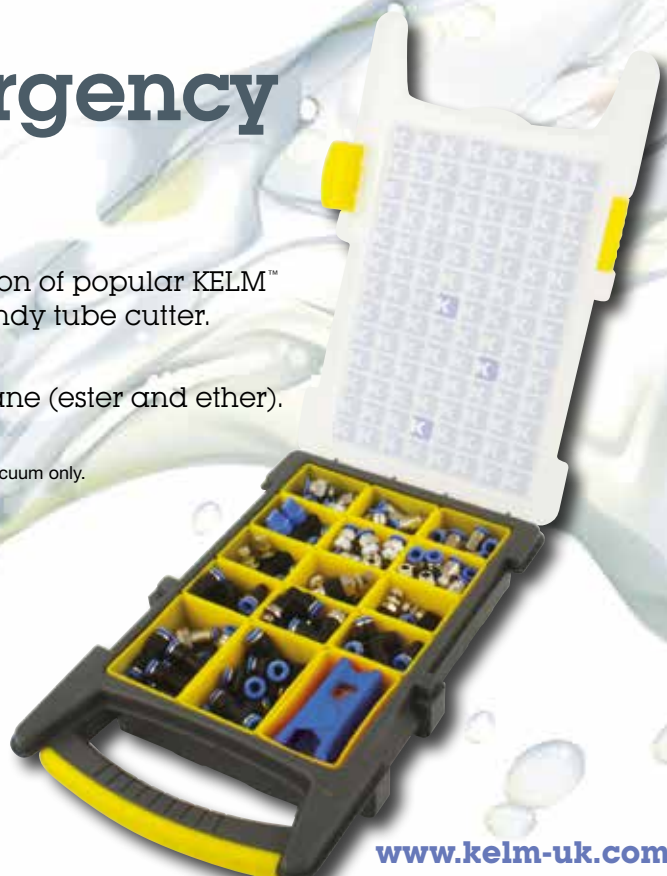

Plastic Push-in

1060	
KELM-06MMBOX-P	6
KELM-08MMBOX-P	8
KELM-10MMBOX-P	10

Page Tech Sheet **1964**

[www.kelm-uk.com](http://www.kelm-uk.com)

### 6mm Plastic Push-in Fittings & Tube Cutter

**CONTENTS:**

<b>Tube Cutter</b> KTC-1 Qty: 1	<b>Equal Tee</b> 2019-8404 Qty: 10	<b>Equal Connector</b> 2019-8305 Qty: 10	<b>Equal Bulkhead</b> 2019-8503 Qty: 2
<b>Equal Elbow</b> 2019-8354 Qty: 8	<b>1/8" BSPP Male Stud Elbow</b> 2028-8247 Qty: 8	<b>1/4" BSPP Male Stud Elbow</b> 2028-8254 Qty: 5	
<b>1/8" BSPT Flow Controller</b> 2022-9852 Qty: 2	<b>1/4" BSPT Flow Controller</b> 2022-9878 Qty: 2	<b>Flow Controller (Unidirectional)</b> 2022-9746 Qty: 2	
<b>1/8" BSPT Male Stud</b> 2019-4965 Qty: 10	<b>1/4" BSPT Male Stud</b> 2019-4973 Qty: 10	<b>Shut-off Valve (Tube x Tube)</b> HVFF06-06 Qty: 2	
<b>M5 BSPT Male Stud</b> 2019-4957 Qty: 5	<b>1/8" BSPP Male Stud</b> 2028-7819 Qty: 10	<b>1/4" BSPP Male Stud</b> 2028-7843 Qty: 10	

### 8mm Plastic Push-in Fittings & Tube Cutter

**CONTENTS:**

<b>Tube Cutter</b> KTC-1 Qty: 1	<b>Equal Tee</b> 2019-8412 Qty: 8	<b>Equal Connector</b> 2019-8313 Qty: 10	<b>Equal Bulkhead</b> 2019-8511 Qty: 2
<b>Equal Elbow</b> 2019-8362 Qty: 6	<b>1/8" BSPP Male Stud Elbow</b> 2028-8270 Qty: 6	<b>1/4" BSPP Male Stud Elbow</b> 2028-8288 Qty: 5	
<b>1/8" BSPT Flow Controller</b> 2022-9886 Qty: 2	<b>1/4" BSPT Flow Controller</b> 2022-9894 Qty: 2	<b>Flow Controller (Unidirectional)</b> 2022-9753 Qty: 2	
<b>1/8" BSPT Male Stud</b> 2019-4999 Qty: 10	<b>1/4" BSPT Male Stud</b> 2019-5004 Qty: 10	<b>Shut-off Valve (Tube x Tube)</b> HVFF08-08 Qty: 2	
<b>3/8" BSPT Male Stud</b> 2019-5012 Qty: 5	<b>1/8" BSPP Male Stud</b> 2028-7876 Qty: 10	<b>1/4" BSPP Male Stud</b> 2028-7884 Qty: 10	

### 10mm Plastic Push-in Fittings & Tube Cutter

**CONTENTS:**

<b>Tube Cutter</b> KTC-1 Qty: 1	<b>Flow Controller (Unidirectional)</b> 2022-9761 Qty: 2	<b>Equal Connector</b> 2019-8321 Qty: 8
<b>Equal Elbow</b> 2019-8370 Qty: 3	<b>1/8" BSPP Male Stud Elbow</b> 2028-8312 Qty: 3	<b>1/4" BSPP Male Stud Elbow</b> 2028-8320 Qty: 3
<b>1/4" BSPT Flow Controller</b> 2022-9928 Qty: 2	<b>3/8" BSPT Flow Controller</b> 2022-9936 Qty: 1	<b>Equal Tee</b> 2019-8420 Qty: 2
<b>1/8" BSPT Male Stud</b> 2019-5038 Qty: 7	<b>1/4" BSPT Male Stud</b> 2019-5046 Qty: 7	<b>Equal Bulkhead</b> 2019-8529 Qty: 2
<b>3/8" BSPT Male Stud</b> 2019-5053 Qty: 5	<b>1/8" BSPP Male Stud</b> 2028-7926 Qty: 8	<b>1/4" BSPP Male Stud</b> 2028-7934 Qty: 6

Please refer to our Fluid Power Catalogue for more information



# One Touch Plastic Push-in Fittings

**Temperature Range:**  
 Brass: 0°C to +60°C  
 Acetal: 0°C to +60°C

**Working Pressure:**  
 10 bar (150 psi)

**Media:**  
 Air & vacuum only.

**Negative Pressure:**  
 -750mm Hg (10Torr)

**Tech Sheet 1964**

## Male Studs



Male Thread, Metric & BSPT

1060	OD mm	Thread
2019-4890	4	M5
2019-4932	4	1/8"
2046-7163	4	M6
2019-4940	4	1/4"
2046-7164	4	3/8"
2019-4957	6	M5
2019-4965	6	1/8"
2046-7165	6	M6
2019-4973	6	1/4"
2019-4981	6	3/8"
2046-7166	6	1/2"
2019-4999	8	1/8"
2019-5004	8	1/4"
2019-5012	8	3/8"
2019-5020	8	1/2"
2019-5038	10	1/8"
2019-5046	10	1/4"
2019-5053	10	3/8"
2019-5061	10	1/2"
2019-5076	12	1/4"
2019-5087	12	3/8"
2019-5095	12	1/2"

## Female Studs



Female Thread, BSPP

1060	OD mm	Thread
2019-6325	4	1/8"
2046-7167	4	1/4"
2019-6366	6	1/8"
2019-6416	6	1/4"
2019-6432	6	3/8"
2019-6440	8	1/8"
2019-6465	8	1/4"
2019-6721	8	3/8"
2046-7168	8	1/2"
2019-6739	10	1/8"
2019-6754	10	1/4"
2019-6911	10	3/8"
2046-7169	10	1/2"
2019-6929	12	1/4"
2019-7018	12	3/8"
2019-7059	12	1/2"

## Male Stud Swivel Elbows



Male Thread, Metric & BSPT

1060	OD mm	Thread
2019-5103	4	M5
2019-5111	4	1/8"
2046-7170	4	M6
2019-5129	4	1/4"
2019-5822	6	M5
2019-5145	6	1/8"
2046-7171	6	M6
2019-5152	6	1/4"
2019-5160	6	3/8"
2046-7172	6	1/2"
2019-5178	8	1/8"
2019-5186	8	1/4"
2019-5194	8	3/8"
2019-5202	8	1/2"
2019-5210	10	1/8"
2019-5228	10	1/4"
2019-5236	10	3/8"
2019-5244	10	1/2"
2019-5251	12	1/4"
2019-5269	12	3/8"
2019-5277	12	1/2"

## Female Bulkhead Connectors



Female Thread, Metric & BSPP

1060	OD mm	Thread	Bulk Head
2046-7194	4	M5	M12 x 1
2019-7083	4	1/8"	M12 x 1
2046-7196	4	1/4"	M12 x 1
2046-7197	6	M5	M14 x 1
2019-7125	6	1/8"	M14 x 1
2046-7198	6	M6	M14 x 1
2019-7133	6	1/4"	M14 x 1
2046-7199	6	3/8"	M14 x 1
2046-7200	6	1/2"	M14 x 1
2046-7201	8	1/8"	M16 x 1
2019-7166	8	1/4"	M16 x 1
2019-7182	8	3/8"	M16 x 1
2046-7202	8	1/2"	M16 x 1
2046-7203	10	1/8"	M20 x 1
2019-7299	10	1/4"	M20 x 1
2019-7307	10	3/8"	M20 x 1
2046-7204	10	1/2"	M20 x 1
2019-7315	12	1/4"	M22 x 1
2019-7497	12	3/8"	M22 x 1
2046-7205	12	1/2"	M22 x 1



Male Thread, BSPP

1060	OD mm	Thread
2028-7736	4	1/8"
2028-7793	4	1/4"
2028-7819	6	1/8"
2028-7843	6	1/4"
2028-7868	6	3/8"
2028-7876	8	1/8"
2028-7884	8	1/4"
2028-7900	8	3/8"
2028-7918	8	1/2"
2028-7926	10	1/8"
2028-7934	10	1/4"
2028-7942	10	3/8"
2028-7959	10	1/2"
2028-7967	12	1/4"
2028-7975	12	3/8"
2028-7983	12	1/2"



Male Thread, BSPP

1060	OD mm	Thread
2028-8221	4	1/8"
2028-8239	4	1/4"
2028-8247	6	1/8"
2028-8254	6	1/4"
2028-8262	6	3/8"
2028-8270	8	1/8"
2028-8288	8	1/4"
2028-8296	8	3/8"
2028-8304	8	1/2"
2028-8312	10	1/8"
2028-8320	10	1/4"
2028-8338	10	3/8"
2028-8379	10	1/2"
2028-8403	12	1/4"
2028-8411	12	3/8"
2028-8429	12	1/2"

FLUID POWER

Please refer to our Fluid Power Catalogue for more information



## Polyurethane Tube

### Metric Polyurethane Ester Tube

Tech Sheet **3131**

**Ester based tube is not suitable for use with water or in high humidity environments.**

- Ester based Polyurethane tubing has outstanding characteristics compared with other pneumatic tubing. This tube is extremely flexible and offers excellent bend capabilities making it ideal for pneumatic control or robotic systems. It is also resistant to many chemicals, gases and oils as well as having excellent abrasion resistance. Ideal for use with Push-in fittings, Compression fittings, Quick-Fit fittings & Hose Tail fittings.



#### Metric, 25 Metre Coils

5030	OD mm	ID mm	PSI	
PU03/020B	3	2	Blue	150
PU04/025N	4	2.5	Black	190
PU04/025B	4	2.5	Blue	190
PU04/025R	4	2.5	Red	190
PU04/025Y	4	2.5	Yellow	190
PU04/025G	4	2.5	Green	190
PU04/025	4	2.5	Transparent	190
PU05/030N	5	3	Black	160
PU05/030B	5	3	Blue	160
PU06/040N	6	4	Black	155
PU06/040B	6	4	Blue	155
PU06/040R	6	4	Red	155
PU06/040Y	6	4	Yellow	155
PU06/040G	6	4	Green	155
PU06/040	6	4	Transparent	155
PU08/055N	8	5.5	Black	150
PU08/055B	8	5.5	Blue	150
PU08/055R	8	5.5	Red	150
PU08/055Y	8	5.5	Yellow	150
PU08/055G	8	5.5	Green	150
PU08/055	8	5.5	Transparent	150
PU08/060N	8	6	Black	120
PU08/060B	8	6	Blue	120
PU08/060R	8	6	Red	120
PU08/060Y	8	6	Yellow	120
PU08/060G	8	6	Green	120
PU08/060	8	6	Transparent	120
PU10/065N	10	6.5	Black	125
PU10/065B	10	6.5	Blue	125
PU10/065R	10	6.5	Red	125
PU10/065Y	10	6.5	Yellow	125
PU10/065G	10	6.5	Green	125
PU10/065	10	6.5	Transparent	125
PU10/080N	10	8	Black	120
PU10/080B	10	8	Blue	120
PU10/080	10	8	Transparent	120
PU12/080N	12	8	Black	120
PU12/080B	12	8	Blue	120
PU12/080R	12	8	Red	120
PU12/080Y	12	8	Yellow	120
PU12/080G	12	8	Green	120
PU12/080	12	8	Transparent	120
PU16/110	16	11	Blue	100

#### Metric, 30 Metre Coils

5030	OD mm	ID mm	PSI	
PU04/025-30	4	2.5	Transparent	190
PU04/025B-30	4	2.5	Blue	190
PU06/040-30	6	4	Transparent	155
PU06/040B-30	6	4	Blue	155
PU08/055-30	8	5.5	Transparent	150
PU08/055B-30	8	5.5	Blue	150
PU08/060-30	8	6	Transparent	120
PU08/060B-30	8	6	Blue	120
PU10/065-30	10	6.5	Transparent	125
PU10/065B-30	10	6.5	Blue	125
PU10/080-30	10	8	Transparent	120
PU10/080B-30	10	8	Blue	120
PU12/080-30	12	8	Transparent	120
PU12/080B-30	12	8	Blue	120

#### Metric, 100 Metre Coils

5030	OD mm	ID mm	PSI	
PU04/025N-100	4	2.5	Black	190
PU04/025B-100	4	2.5	Blue	190
PU04/025R-100	4	2.5	Red	190
PU04/025Y-100	4	2.5	Yellow	190
PU04/025G-100	4	2.5	Green	190
PU04/025-100	4	2.5	Transparent	190
PU06/040N-100	6	4	Black	155
PU06/040B-100	6	4	Blue	155
PU06/040R-100	6	4	Red	155
PU06/040Y-100	6	4	Yellow	155
PU06/040G-100	6	4	Green	155
PU06/040-100	6	4	Transparent	155
PU08/055N-100	8	5.5	Black	150
PU08/055B-100	8	5.5	Blue	150
PU08/055R-100	8	5.5	Red	150
PU08/055Y-100	8	5.5	Yellow	150
PU08/055G-100	8	5.5	Green	150
PU08/055-100	8	5.5	Transparent	150
PU08/060N-100	8	6	Black	120
PU08/060B-100	8	6	Blue	120
PU08/060R-100	8	6	Red	120
PU08/060Y-100	8	6	Yellow	120
PU08/060G-100	8	6	Green	120
PU08/060-100	8	6	Transparent	120
PU10/065N-100	10	6.5	Black	125
PU10/065B-100	10	6.5	Blue	125
PU10/065R-100	10	6.5	Red	125
PU10/065Y-100	10	6.5	Yellow	125
PU10/065G-100	10	6.5	Green	125
PU10/065-100	10	6.5	Transparent	125
PU10/080N-100	10	8	Black	120
PU10/080B-100	10	8	Blue	120
PU10/080R-100	10	8	Red	120
PU10/080Y-100	10	8	Yellow	120
PU10/080G-100	10	8	Green	120
PU10/080-100	10	8	Transparent	120
PU12/080N-100	12	8	Black	120
PU12/080B-100	12	8	Blue	120
PU12/080R-100	12	8	Red	120
PU12/080G-100	12	8	Green	120
PU12/080-100	12	8	Transparent	120

FLUID POWER

Please refer to our Fluid Power Catalogue for more information



# Nylon Tubing & Tube Cutters

## Metric Flexible Nylon Tubing, Type NT (to BS5409)

Tube is not suitable for use with water or in high humidity environments.

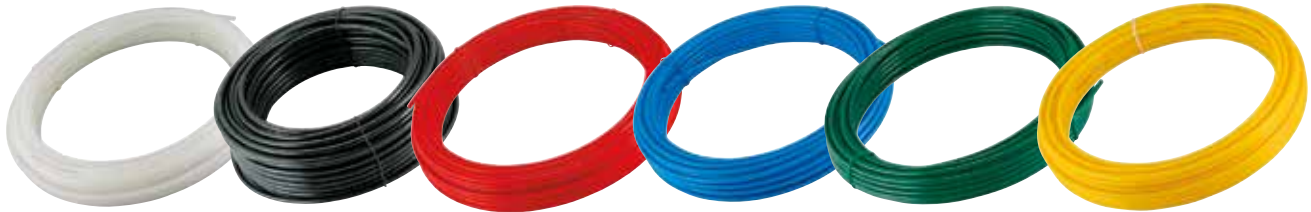

**Temperature Range:**  
-10°C to +80°C

- U.V. Stable
- Silicone Free

- Abrasion Resistant
- Manufactured from quality grade nylon granules.

Other colours and lengths available on request

The properties of this tube make it ideal for use in pneumatic control systems. (Ideally suited for use with push-in fittings).

### 30 Metre Coils

5010	OD mm	ID mm	PSI	PSI
NTM04/030	4	3	Natural	300
NTM04/025	4	2.5	Natural	400
NTM04/025N	4	2.5	Black	400
NTM04/025B	4	2.5	Blue	400
NTM04/025G	4	2.5	Green	400
NTM04/025R	4	2.5	Red	400
NTM04/025Y	4	2.5	Yellow	400
NTM05/030	5	3	Natural	400
NTM05/030N	5	3	Black	400
NTM05/030B	5	3	Blue	400
NTM05/030G	5	3	Green	400
NTM05/030R	5	3	Red	400
NTM05/030Y	5	3	Yellow	400
NTM05/033	5	3.3	Natural	300
NTM06/040	6	4	Natural	350
NTM06/040N	6	4	Black	350
NTM06/040B	6	4	Blue	350
NTM06/040G	6	4	Green	350
NTM06/040R	6	4	Red	350
NTM06/040Y	6	4	Yellow	350
NTM06/045	6	4.5	Natural	300
NTM08/060	8	6	Natural	350
NTM08/060N	8	6	Black	350
NTM08/060B	8	6	Blue	350
NTM08/060G	8	6	Green	350
NTM08/060R	8	6	Red	350
NTM08/060Y	8	6	Yellow	350
NTM08/055	8	5.5	Natural	350

### 30 Metre Coils

5010	OD mm	ID mm	PSI	PSI
NTM08/055N	8	5.5	Black	350
NTM10/070	10	7	Natural	300
NTM10/070N	10	7	Black	300
NTM10/070B	10	7	Blue	300
NTM10/070G	10	7	Green	300
NTM10/070R	10	7	Red	300
NTM10/070Y	10	7	Yellow	300
NTM10/080	10	8	Natural	220
NTM10/080N	10	8	Black	220
NTM10/080B	10	8	Blue	220
NTM10/080G	10	8	Green	220
NTM10/080R	10	8	Red	220
NTM10/080Y	10	8	Yellow	220
NTM12/090	12	9	Natural	250
NTM12/090N	12	9	Black	250
NTM12/090B	12	9	Blue	250
NTM12/090G	12	9	Green	250
NTM12/090R	12	9	Red	250
NTM12/090Y	12	9	Yellow	250
NTM12/100	12	10	Natural	200
NTM12/100N	12	10	Black	200
NTM12/100R	12	10	Red	200
NTM14/110	14	11	Natural	250
NTM14/110N	14	11	Black	250
NTM15/120	15	12	Natural	200
NTM16/130	16	13	Natural	200
NTM18/140	18	14	Natural	200
NTM22/170	22	17	Natural	180

### 100 Metre Coils

5010	OD mm	ID mm	PSI	PSI
NTM04/025-100	4	2.5	Natural	400
NTM05/030-100	5	3	Natural	400
NTM06/040-100	6	4	Natural	350
NTM06/040N-100	6	4	Black	350
NTM06/040B-100	6	4	Blue	350
NTM06/040G-100	6	4	Green	350
NTM06/040R-100	6	4	Red	350
NTM06/040Y-100	6	4	Yellow	350
NTM08/060-100	8	6	Natural	350
NTM08/060N-100	8	6	Black	350
NTM08/060B-100	8	6	Blue	350
NTM10/080-100	10	8	Natural	220
NTM10/080N-100	10	8	Black	220
NTM10/080B-100	10	8	Blue	220

### 500 Metre Drums

5010	OD mm	ID mm	PSI	PSI
NTM06/040-500	6	4	Natural	350
NTM06/040-500B	6	4	Blue	350
NTM08/060-500	8	6	Natural	350

Tech Sheet 3136

## Nylon & Polyurethane Tube Cutter

3mm-16mm

5010

KTC-1



Blue



## Nylon Tubing

This range of nylon products is produced in a state-of-the-art manufacturing facility. All products undergo rigorous testing to ensure the optimum life can be achieved from the end product. Tube can be produced to your special requirements with optional length, size, colour and branding available (minimum quantities and lead times will apply). Please contact our Business Development Team for further information.

Please refer to our Fluid Power Catalogue for more information



## Air Preparation Filter/Regulator & Lubricator



### Specification

Model	KCS200-06	KCS200-08	KCS300-08	KCS300-10	KCS300-15	KCS400-10	KCS400-15	KCS600-20	KCS600-25	
Fluid	Air									
Port	1/8"	1/4"	1/4"	3/8"	1/2"	3/8"	1/2"	3/4"	1"	
Micron	40µm or 5µm									
Pressure Range	Semi-Auto & Automatic Drain: 0.15-0.9MPa (20-130psi)									
	Manual Drain: 0.05-0.9MPa (7-130psi)									
Proof Pressure	1.5 MPa (215psi)									
Temperature Range	-5 to +60°C									
Capacity of Drain Bowl	10CC		40CC			80CC		230CC		
Capacity of Oil Bowl	25CC		75CC			160CC		380CC		
Recommended Lubricant	ISO VG 32 or equivalent									
Weight	580g		1300g			2360g		5550g		
	Filter	KFS200-06	KFS200-08	KFS300-08	KFS300-10	KFS300-15	KFS400-10	KFS400-15	KFS600-20	KFS600-25
Constitute	Regulator	KRS200-06	KRS200-08	KRS300-08	KRS300-10	KRS300-15	KRS400-10	KRS400-15	KRS600-20	KRS600-25
	Lubricator	KLS200-06	KLS200-08	KLS300-08	KLS300-10	KLS300-15	KLS400-10	KLS400-15	KLS600-20	KLS600-25

### Symbol

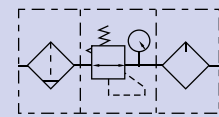

### Ordering Code

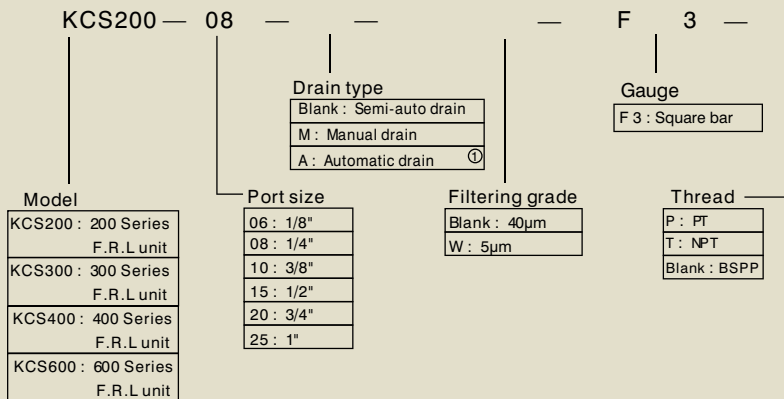

① The function of automatic drain is not available for KCS200 series

### Product Features

- 1 Gap seal structure makes oil supply adjustment more reliable.
- 2 The adjustment ring for the oil supply will revolve once through 360° thus oil supply can be gauged by the position of the graduated ring.
- 3 Oil is fed into the system by venturi nozzle.
- 4 Installation is quick and reliable.
- 5 Pressure adjustment is precise.
- 6 Filtration 40 micron or 5 micron.
- 7 Three drain types are available manual drain, semi-auto drain and automatic drain.

### Pressure Charts

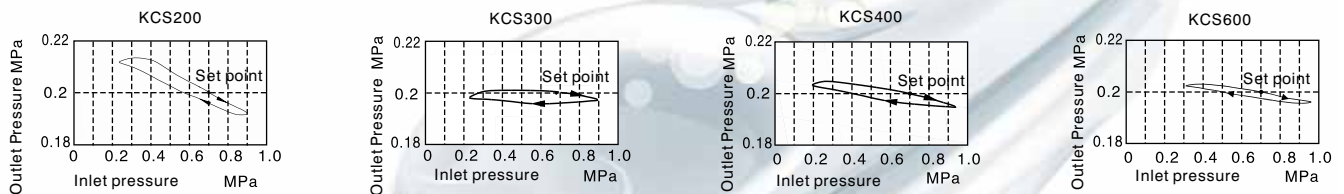

### Flow Charts (Inlet Pressure 0.7MPa)

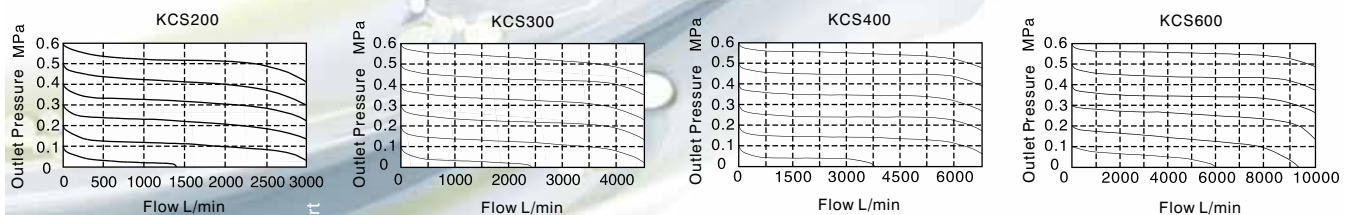

Please refer to our Fluid Power Catalogue for more information



# Braided PVC Hose

Reinforced PVC Braided Hose,  
Type RPVC & HDPVC (to BS6066)

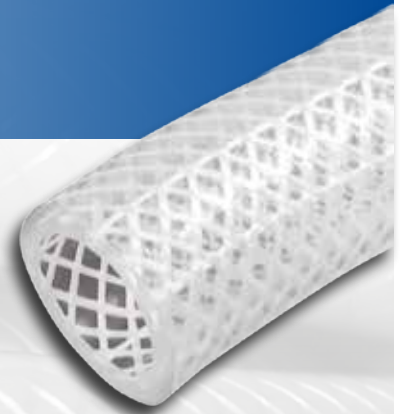

Part Number	Nominal Dimension	ID x OD mm	Max. Working Pressure bar	Burst Pressure bar	Bend Radius mm	Weight kg/roll
RPVC18	1/8"	3 x 8	13	50	15	1.10
RPVC532	5/32"	4 x 9	13	50	17	1.80
RPVC316	3/16"	5 x 10	13	50	20	2.10
RPVC14	1/4"	6 x 11	15	65	25	2.30
RPVC516	5/16"	8 x 13	15	58	33	2.70
RPVC38	3/8"	10 x 15	12	45	40	3.20
RPVC12	1/2"	13 x 18	12	40	52	4.00
RPVC58	5/8"	16 x 21	10	35	64	5.00
RPVC34	3/4"	19 x 25	10	32	76	7.10
RPVC1	1"	25 x 31	9	28	100	8.90
RPVC114	1.1/4"	32 x 40	6	26	125	16.00
RPVC112	1.1/2"	38 x 46	5	20	152	19.00
RPVC2	2"	50 x 60	3	17	200	31.00
<hr/>						
HDPVC14	1/4"	6.5 x 11.5	16	65	30	2.50
HDPVC516	5/16"	8 x 13.5	16	58	35	3.30
HDPVC38	3/8"	10 x 16	15	45	45	3.50
HDPVC12	1/2"	12.5 x 18.5	12	40	52	5.00
HDPVC58	5/8"	16 x 23	10	35	74	7.80
HDPVC34	3/4"	20 x 26	10	32	80	7.30
HDPVC1	1"	25 x 33	10	28	110	12.80
HDPVC114	1.1/4"	32 x 41	6	26	130	18.90
HDPVC112	1.1/2"	40 x 49	6	20	165	23.00
HDPVC2	2"	50 x 62	3	17	220	38.00

Given working pressures are based on an ambient temperature of 20°C. Due to the natural properties of PVC, as the ambient temperature increases the pressures the hose will withstand decrease at an average rate of 15% per increase of 10°C and in similar increments thereafter.



Please refer to our Fluid Power Catalogue for more information

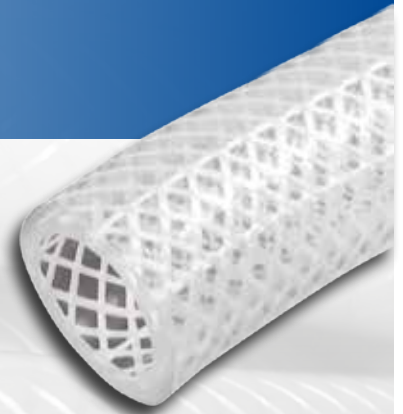

# Braided PVC Hose

## Reinforced PVC Braided Hose, Type RPVC & HDPVC (to BS6066)

Manufactured from top quality crystal clear 'virgin' PVC compound, and ideal for factory airlines, fluid systems and many industrial applications. Reinforced with a high tensile quality polyester yarn, it offers high working pressures and extreme flexibility.

The hose is resistant to a wide range of chemicals (please consult our Business Development Team for further details).

### Applications:

- Water supply and draining
- Transfer of various fluids and powder
- Supplying water, gas, oil, etc. in agriculture and industry
- Compressed air
- Other special purposes

### Characteristics:

- Excellent abrasion resistance
- High resistance to alkalis and acids
- Silicone free
- Cadmium free
- Low toxicity
- Excellent transparency
- Manufactured to comply with BS6066 and ISO5774
- Produced from FDA approved materials
- Durable, anti-cold proof, non-inflated
- Highly flexible, lightweight and easy to handle
- No fissure phenomenon by ultraviolet rays and direct rays of the sun
- Little expansion or contraction

<b>Length*</b>	15m	30m	100m
<b>Size</b>	From 3/16" ID to 2" ID		
<b>Temperature</b>	Min -20°C	Max +65°C	

\*Other lengths available on request.



Please refer to our Fluid Power Catalogue for more information

FLUID  
POWER



# Braided PVC Hose

Reinforced PVC Braided Hose,  
Type RPVC & HDPVC (to BS6066)

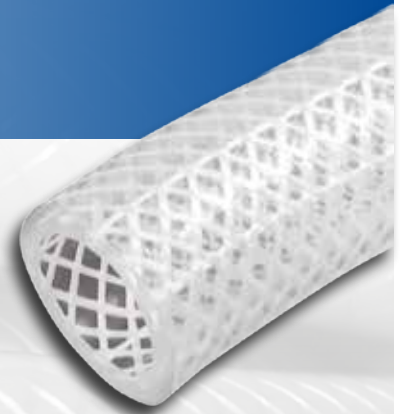

Part Number	Nominal Dimension	ID x OD mm	Max. Working Pressure bar	Burst Pressure bar	Bend Radius mm	Weight kg/roll
RPVC18	1/8"	3 x 8	13	50	15	1.10
RPVC532	5/32"	4 x 9	13	50	17	1.80
RPVC316	3/16"	5 x 10	13	50	20	2.10
RPVC14	1/4"	6 x 11	15	65	25	2.30
RPVC516	5/16"	8 x 13	15	58	33	2.70
RPVC38	3/8"	10 x 15	12	45	40	3.20
RPVC12	1/2"	13 x 18	12	40	52	4.00
RPVC58	5/8"	16 x 21	10	35	64	5.00
RPVC34	3/4"	19 x 25	10	32	76	7.10
RPVC1	1"	25 x 31	9	28	100	8.90
RPVC114	1.1/4"	32 x 40	6	26	125	16.00
RPVC112	1.1/2"	38 x 46	5	20	152	19.00
RPVC2	2"	50 x 60	3	17	200	31.00
<hr/>						
HDPVC14	1/4"	6.5 x 11.5	16	65	30	2.50
HDPVC516	5/16"	8 x 13.5	16	58	35	3.30
HDPVC38	3/8"	10 x 16	15	45	45	3.50
HDPVC12	1/2"	12.5 x 18.5	12	40	52	5.00
HDPVC58	5/8"	16 x 23	10	35	74	7.80
HDPVC34	3/4"	20 x 26	10	32	80	7.30
HDPVC1	1"	25 x 33	10	28	110	12.80
HDPVC114	1.1/4"	32 x 41	6	26	130	18.90
HDPVC112	1.1/2"	40 x 49	6	20	165	23.00
HDPVC2	2"	50 x 62	3	17	220	38.00

Given working pressures are based on an ambient temperature of 20°C. Due to the natural properties of PVC, as the ambient temperature increases the pressures the hose will withstand decrease at an average rate of 15% per increase of 10°C and in similar increments thereafter.



Please refer to our Fluid Power Catalogue for more information





# Nickel Plated Brass & Brass Hose Tails

This technical data is applicable to the full range of hose tail fittings and air line fittings including tees, elbows, reducers and silencers, etc.

**Threads:**

Tapered in conformity with ISO 7.1, BS 21, DIN 2999.

Parallel in conformity with ISO 228 class A.

Metric in conformity with ISO R/262.

**Media:**

Compressed air, water, oils and fluids in general for the hydraulic and pneumatic fields.

**NB:**

Safe pressures and temperatures depend entirely on the tubes being used, for this reason the values must be determined in accordance with the tube features.



## Male x Hose Tail, Brass

Male Thread, BSPT

1010		To Suit Hose I.D.
GT10/04K	1/8"	1/8"
GT10/05K	1/8"	3/16"
GT10/06K	1/8"	1/4"
GT10/08K	1/8"	5/16"
GT10/09K	1/8"	3/8"
GT10/13K	1/8"	1/2"
GT13/04K	1/4"	1/8"
GT13/05K	1/4"	3/16"
GT13/06K	1/4"	1/4"
GT13/08K	1/4"	5/16"
GT13/09K	1/4"	3/8"
GT13/13K	1/4"	1/2"
GT13/16K	1/4"	5/8"
GT13/19K	1/4"	3/4"
GT17/05K	3/8"	3/16"
GT17/06K	3/8"	1/4"
GT17/08K	3/8"	5/16"
GT17/09K	3/8"	3/8"
GT17/13K	3/8"	1/2"
GT17/16K	3/8"	5/8"
GT17/19K	3/8"	3/4"
GT21/05K	1/2"	3/16"
GT21/06K	1/2"	1/4"
GT21/08K	1/2"	5/16"
GT21/09K	1/2"	3/8"
GT21/13K	1/2"	1/2"
GT21/16K	1/2"	5/8"
GT21/19K	1/2"	3/4"
GT21/25K	1/2"	1"
GT23/16K	5/8"	5/8"
GT26/06K	3/4"	1/4"
GT26/08K	3/4"	5/16"
GT26/09K	3/4"	3/8"
GT26/13K	3/4"	1/2"
GT26/16K	3/4"	5/8"
GT26/19K	3/4"	3/4"
GT26/25K	3/4"	1"
GT26/31K	3/4"	1.1/4"
GT33/13K	1"	1/2"
GT33/16K	1"	5/8"
GT33/19K	1"	3/4"
GT33/25K	1"	1"
GT33/31K	1"	1.1/4"
GT33/38K	1"	1.1/2"
GT42/19K	1.1/4"	3/4"
GT42/25K	1.1/4"	1"
GT42/31K	1.1/4"	1.1/4"
GT48/31K	1.1/2"	1.1/4"
GT48/38K	1.1/2"	1.1/2"
GT48/50K	1.1/2"	2"
GT52/38K	2"	1.1/2"
GT52/50K	2"	2"
GT56/53K	2.1/2"	2.1/2"
GT60/58K	3"	3"

## Male x Hose Tail, Nickel Plated Brass

Male Thread, BSPT

1010		To Suit Hose I.D.
GT10/04KNP	1/8"	1/8"
GT10/05KNP	1/8"	3/16"
GT10/06KNP	1/8"	1/4"
GT10/08KNP	1/8"	5/16"
GT10/09KNP	1/8"	3/8"
GT13/04KNP	1/4"	1/8"
GT13/05KNP	1/4"	3/16"
GT13/06KNP	1/4"	1/4"
GT13/08KNP	1/4"	5/16"
GT13/09KNP	1/4"	3/8"
GT13/13KNP	1/4"	1/2"
GT13/16KNP	1/4"	5/8"
GT13/19KNP	1/4"	3/4"
GT17/05KNP	3/8"	3/16"
GT17/06KNP	3/8"	1/4"
GT17/08KNP	3/8"	5/16"
GT17/09KNP	3/8"	3/8"
GT17/13KNP	3/8"	1/2"
GT17/16KNP	3/8"	5/8"
GT17/19KNP	3/8"	3/4"
GT21/06KNP	1/2"	1/4"
GT21/08KNP	1/2"	5/16"
GT21/09KNP	1/2"	3/8"
GT21/13KNP	1/2"	1/2"
GT21/16KNP	1/2"	5/8"
GT21/19KNP	1/2"	3/4"
GT21/25KNP	1/2"	1"
GT26/09KNP	3/4"	3/8"
GT26/13KNP	3/4"	1/2"
GT26/16KNP	3/4"	5/8"
GT26/19KNP	3/4"	3/4"
GT26/25KNP	3/4"	1"
GT33/13KNP	1"	1/2"
GT33/19KNP	1"	3/4"
GT33/25KNP	1"	1"
GT33/38KNP	1"	1.1/2"
GT33/31KNP	1"	1.1/4"
GT42/25KNP	1.1/4"	1"
GT42/31KNP	1.1/4"	1.1/4"
GT48/38KNP	1.1/2"	1.1/2"
GT48/50KNP	1.1/2"	2"
GT52/38KNP	2"	1.1/2"
GT52/50KNP	2"	2"

FLUID POWER

Tech Sheet 20089

Please refer to our Fluid Power Catalogue for more information



# Wire Reinforced Suction Hose

Page Tech Sheet 20214

## Wire Reinforced Suction Hose

Clear PVC reinforced with a tensile steel helix

**Applications:** Suitable for the suction and discharge of water, slurry, chemicals, sewage, granules and other waste materials; can also be used for suction and discharge of foodstuffs.

**Pressures:** Values given are based on the short term burst pressure of the hose at 20°C based on a 3:1 safety factor.

**Note:** Any increase in temperature above 20°C will result in a decline in working pressure values.

**Chemical Resistance:** Resistant to most oxidising and reducing agents and diluted acids and alkalis. For more detailed information please contact technical sales.

**Approvals:** Hose complies fully to EU No.10/201 on plastic materials and articles intended to come into contact with food.

**Cold bend:** -45°C

**Vacuum:** 711mm Hg = 94% at 20°C



### Clear with Blue Wire Spiral, 10 Metre Coils

5997	-ID-	mm	bar	mm
FX075-10	3/4"	3.4	6	80
FX100-10	1"	4	6	100
FX125-10	1.1/4"	4.8	5	130
FX150-10	1.1/2"	5.5	5	155
FX200-10	2"	7	5	200
FX250-10	2.1/2"	7	4	260
FX300-10	3"	8	4	320
FX400-10	4"	8	4	430

### Clear with Blue Wire Spiral, 30 Metre Coils

5997	-ID-	mm	bar	mm
FX050-30	1/2"	3	6	50
FX075-30	3/4"	3.4	6	80
FX100-30	1"	4	6	100
FX125-30	1.1/4"	4.8	5	130
FX150-30	1.1/2"	5.5	5	155
FX200-30	2"	7	5	200
FX250-30	2.1/2"	7	4	260
FX300-30	3"	8	4	320
FX400-30	4"	8	4	430

Please refer to our Fluid Power Catalogue for more information

FLUID POWER



# Industrial PU Ducting

This high performance ducting range is manufactured in Europe and is made from premium-grade ester polyurethane compound, reinforced with a copper coated spring steel helix.

**Applications:** transport hose for abrasive solids including: dust, powder, fibres, etc. Also suitable for extracting gaseous media such as oil vapours and welding fume.

 **Working Temperature:**  
-40°C to +90°C

**Intermittent to:**  
+125°C

- Excellent abrasion resistance
- Wire spiral reinforcement can be earthed
- Super flexible, low weight
- Small bend radius
- Resistant to oil, petrol and chemicals
- High tensile strength and tear resistance
- Good UV and ozone resistance

**New Features:**

- New construction
- Higher vacuum rating
- Improved airflow

## Lightweight High Performance Polyurethane

**Wall Thickness:** 0.4mm approx.

Supplied in compressed form (4:1) to save space and cost.

Use clamp type 212/212EC (refer to page 1321).

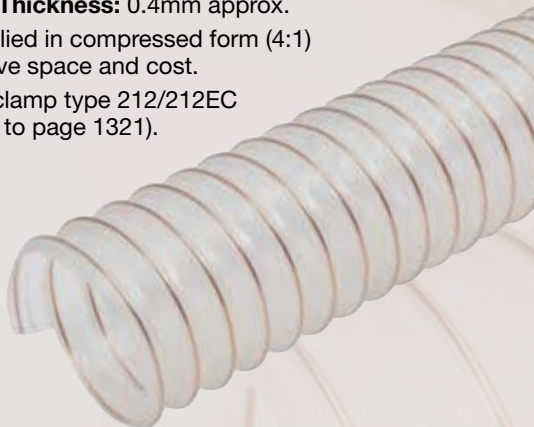

## Medium Weight High Performance Polyurethane

**Wall Thickness:** 0.6mm approx.

Supplied in compressed form (4:1) to save space and cost.

Use clamp type 212/212EC (refer to page 1321).



0.4mm Wall Thickness, 10 Metres

0391	ID mm	OD mm	bar	Vacuum bar	kg per mt
PURLW-38	38	46	0.630	0.245	0.220
PURLW-50	50	58	0.480	0.170	0.280
PURLW-60	60	68	0.405	0.145	0.340
PURLW-65	65	73	0.370	0.130	0.360
PURLW-75	75	83	0.325	0.115	0.410
PURLW-80	80	88	0.305	0.110	0.440
PURLW-90	90	98	0.270	0.095	0.490
PURLW-100	100	108	0.245	0.055	0.510
PURLW-115	115	123	0.210	0.050	0.580
PURLW-120	120	128	0.205	0.045	0.610
PURLW-125	125	133	0.195	0.045	0.630
PURLW-130	130	138	0.185	0.040	0.660
PURLW-140	140	148	0.175	0.040	0.710
PURLW-150	150	158	0.160	0.035	0.760
PURLW-160	160	168	0.150	0.035	0.810
PURLW-180	180	188	0.135	0.030	0.900
PURLW-200	200	208	0.120	0.025	1.030
PURLW-225	225	234	0.110	0.020	1.160
PURLW-250	250	259	0.100	0.020	1.280

0.6mm Wall Thickness, 10 Metres

0391	ID mm	OD mm	bar	Vacuum bar	kg per mt
PURMW-38	38	45	1.075	0.355	0.220
PURMW-50	50	58	0.820	0.220	0.370
PURMW-60	60	68	0.685	0.180	0.430
PURMW-65	65	73	0.635	0.165	0.460
PURMW-75	75	83	0.550	0.145	0.530
PURMW-80	80	88	0.515	0.135	0.570
PURMW-90	90	98	0.460	0.120	0.630
PURMW-100	100	108	0.415	0.080	0.670
PURMW-115	115	123	0.360	0.070	0.760
PURMW-120	120	128	0.345	0.065	0.790
PURMW-125	125	133	0.335	0.065	0.830
PURMW-130	130	138	0.320	0.060	0.860
PURMW-140	140	148	0.295	0.055	0.920
PURMW-150	150	158	0.275	0.055	0.990
PURMW-160	160	168	0.260	0.050	1.050
PURMW-180	180	188	0.230	0.045	1.170
PURMW-200	200	208	0.210	0.030	1.330
PURMW-225	225	233	0.185	0.025	1.480
PURMW-250	250	258	0.165	0.025	1.640
PURMW-300	300	309	0.140	0.020	2.140
PURMW-350	350	359	0.120	0.020	2.490
PURMW-400	400	409	0.105	0.015	2.840

Available per metre, contact sales for more information.

Please refer to our Fluid Power Catalogue for more information



# Superior Safety Compressed Air Hose Assemblies





DCH hose is manufactured with a special formula which will outperform PVC and rubber in all application requirements.

- Greater temperature range for all weather and environment applications
- Improved abrasion compared to both PVC and rubber
- Tensile strength 10% better than rubber up to 150kg
- Coupling retention tried and tested up to 200kg
- Excellent flexibility
- Full hose traceability

All assemblies are supplied complete with Jaymac safety claw couplings, rubber sealing ring and anti-vibration nuts.

- Condition:** lab temperature @ 25C
- Pressure test:** Burst pressure 72Bar,
- Hardness test:**
  - Inside layer:** 77A
  - Outside layer:** 72A
- Temperature test:** tested to -30°C
- NOTE:** Optimize bend radius at 25°C
- Peel strength:** 4.45kgf
- Expansion rate:** 2.4%
- Extension rate:** -4.7%

 **Working Temperature:** -30°C to +60°C

 **Maximum Working Pressure:** 20 bar 3:1 ratio

Specification	ID	OD	Length	W.P.	B.P.	Bend Radius	Working Temperature
INCH	MM	MM	M	BAR	BAR	MM	
3/4	19	29	15	20	60	60	-30°C to +60°C

Please refer to our Fluid Power Catalogue for more information

FLUID POWER



# HYDRAULIC HOSE RANGE

420 bar (6090 psi) – 10 bar (145 psi)

- Superior performance
- Superior quality
- Manufactured and tested to stringent international standards
- Competitively priced

#### The range consists of:

- EN853-1
- EN853-2
- MSHA approved EN853-2
- EN857-1SC compact
- EN857-2SC compact
- EN856-4SP
- EN856-4SH
- SAE100R17
- 100R4
- 100R6
- 100R6 coloured
- 100R7 thermoplastic
- 100R7 twin
- 100R8
- Wire braid steam hose
- PTFE convoluted and smooth bore
- Thermoplastic paint spray
- Thermoplastic sewer jetting

Proven reliability and effectiveness ensures that this range of hydraulic hose is used extensively in manufacturing facilities and in the mobile plant industry.

The hose is **colour coded** for easier identification and available for **special order** with the option of **customers' own branding\***.

#### Hose assembly service available

If you have any requirements for sizes or types of hose not shown in the catalogue please contact a member of our Business Development Team.

Tech Sheet  
5000

Please refer to our Fluid Power Catalogue for more information



# Retention System for Pressure Hoses

Prevent whipping of a pressurised hose in the event of the hose separating from its fitting



**SUITABLE FOR VARIOUS APPLICATIONS, INCLUDING:**

- DIN & BSP Fittings
- JIC Fittings
- SAE Flanges

- Protects both the operator and components
- Recommended by the International Hydraulic Safety Authority – the world leader in hydraulic safety training
- Suitable for all kinds of flexible hose
- Tested protection: compliant with EN 853, EN 854, EN 855, EN 856, EN 857, SAE J517

## How it works...

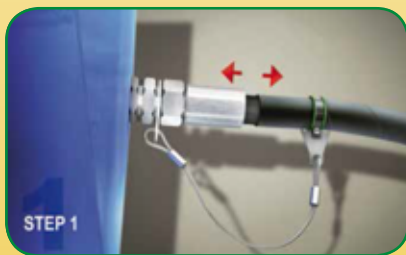

**1: Disengagement:**  
A hose disengages from its ferrule.



**2: Release/venting of pressure**  
The pressurised oil exits from the hose and the release of energy results in the hose gaining considerable velocity, triggering a hazardous “whip effect” which is very dangerous to anyone or anything in its vicinity.



**Step 3: Restraint**  
This is where the Stopflex system gets into operation: the stainless steel cable is tensioned and restrains the hose, preventing it from ‘whipping’. The plate cuts into the rubber of the hose, to ensure that the clamp remains firmly attached. The hose clamp and plate absorb the force released from the travel of the flexible hose. This critical step occurs within just a few seconds.

Please refer to our Fluid Power Catalogue for more information

FLUID  
POWER



Hy-fitt has a quality range of hydraulic quick release couplings which have been manufactured to the highest specification using quality materials.

The range consists of interchange couplings designed to meet or exceed ISO A, ISO B, Flat Faced ISO 16028, Trailer Break ISO 5676, Spin on High Pressure 88, 97 and 98 Series, in a variation of coated steel, stainless steel and brass.



Hy-fitt quick release couplings are tried, tested and used extensively throughout the world's manufacturing facilities and in the mobile plant industry.

### Applications:

- Hydraulics
- Offshore
- Construction
- Marine
- Agriculture
- High pressure water applications
- Mining
- OEM machine building

**NOW INCLUDES VITON SEALING OPTIONS FOR MORE AGGRESSIVE MEDIA**

Please refer to our Fluid Power Catalogue for more information



# The leader in coupling innovation

- DNP combine sophisticated complex technology, highly skilled and experienced operators, tight production and assembly controls, and systematic vigorous testing in order to produce a vast range of superior couplings.
- Quality assurance ISO 9002.
- Interchangeable couplings with other major manufacturers.
- The range consists of over 60 varieties of couplings, including ISO A, ISO B, flat face, screw/ISO 14541 and push-pull, with working pressures up to 1500 bar.
- The range also includes multi-coupling plates which allow simultaneous coupling and uncoupling of a certain number of hydraulic and/or electrical lines.



- Selected ranges (flat face – PVT4 BOP, PVTX BOP, PST4 BOP and ISO B – PBV1 BOP) come with Lloyds registered approval. The range is specially designed for blow-out preventer accumulator systems in the oil and gas market.

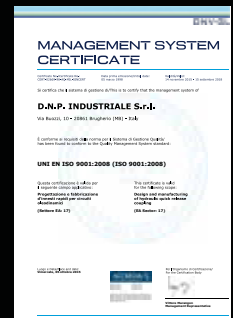

**FULL RANGE AVAILABLE**

**Tech Sheet 20574**

Please refer to our Fluid Power Catalogue for more information

FLUID POWER





# Metric Hydraulic Tubing

## Hydraulic Tubing

3 metre lengths next day.

6 metre lengths may take up to 3 working days to be delivered, dependant on weight and delivery address location. Additional carriage charges may apply.

For full details please contact Business Development Team.

Minimum of 10 Lengths is advised up to 8mm to prevent damage in transit.



### Chrome 6 Free, 3 Metre Lengths

0201	OD mm	mm	Pressure Kg/cm <sup>2</sup>
HST4X1.0-C6F	4	1	624
HST6X1.0-C6F	6	1	365
HST6X1.5-C6F	6	1.5	624
HST6X2.0-C6F	6	2	989
HST8X1.0-C6F	8	1	259
HST8X1.5-C6F	8	1.5	423
HST8X2.0-C6F	8	2	624
HST10X1.0-C6F	10	1	201
HST10X1.5-C6F	10	1.5	321
HST10X2.0-C6F	10	2	460
HST12X1.0-C6F	12	1	164
HST12X1.5-C6F	12	1.5	259
HST12X2.0-C6F	12	2	365
HST14X1.5-C6F	14	1.5	217
HST14X2.0-C6F	14	2	303
HST15X1.5-C6F	15	1.5	201
HST15X2.0-C6F	15	2	279
HST16X1.5-C6F	16	1.5	187
HST16X2.0-C6F	16	2	259
HST16X2.5-C6F	16	2.5	337
HST16X3.0-C6F	16	3	423
HST18X1.5-C6F	18	1.5	164
HST18X2.0-C6F	18	2	226
HST18X2.5-C6F	18	2.5	300
HST20X2.0-C6F	20	2	201
HST20X2.5-C6F	20	2.5	259
HST20X3.0-C6F	20	3	321
HST20X3.5-C6F	20	3.5	388
HST20X4.0-C6F	20	4	460
HST22X1.5-C6F	22	1.5	132
HST22X2.0-C6F	22	2	181
HST22X2.5-C6F	22	2.5	232
HST25X1.5-C6F	25	1.5	115
HST25X2.0-C6F	25	2	157
HST25X2.5-C6F	25	2.5	201
HST25X3.0-C6F	25	3	247
HST25X4.0-C6F	25	4	347
HST28X1.5-C6F	28	1.5	102
HST28X2.0-C6F	28	2	139
HST28X2.5-C6F	28	2.5	177
HST28X3.0-C6F	28	3	217
HST30X2.5-C6F	30	2.5	164
HST30X3.0-C6F	30	3	201
HST30X4.0-C6F	30	4	279
HST35X2.0-C6F	35	2	109
HST35X2.5-C6F	35	2.5	139
HST35X3.0-C6F	35	3	169
HST35X5.0-C6F	35	5	303
HST38X3.0-C6F	38	3	155
HST38X4.0-C6F	38	4	213
HST42X3.0-C6F	42	3	139
HST42X4.0-C6F	42	4	190
HST50X3.0-C6F	50	3	115
HST50X5.0-C6F	50	5	201
HST50X6.0-C6F	50	6	247

### Chrome 6 Free, 6 Metre Lengths

0201	OD mm	mm	Pressure Kg/cm <sup>2</sup>
HST10X1.0-C6F-6M	10	1	201
HST10X1.5-C6F-6M	10	1.5	321
HST10X2.0-C6F-6M	10	2	460
HST12X1.0-C6F-6M	12	1	164
HST12X1.5-C6F-6M	12	1.5	259
HST12X2.0-C6F-6M	12	2	365
HST14X1.5-C6F-6M	14	1.5	217
HST14X2.0-C6F-6M	14	2	303
HST15X1.5-C6F-6M	15	1.5	201
HST15X2.0-C6F-6M	15	2	279
HST16X1.5-C6F-6M	16	1.5	187
HST16X2.0-C6F-6M	16	2	259
HST16X2.5-C6F-6M	16	2.5	337
HST16X3.0-C6F-6M	16	3	423
HST18X1.5-C6F-6M	18	1.5	164
HST18X2.0-C6F-6M	18	2	226
HST18X2.5-C6F-6M	18	2.5	392
HST20X2.0-C6F-6M	20	2	201
HST20X2.5-C6F-6M	20	2.5	259
HST20X3.0-C6F-6M	20	3	321
HST20X3.5-C6F-6M	20	3.5	388
HST20X4.0-C6F-6M	20	4	460
HST22X1.5-C6F-6M	22	1.5	132
HST22X2.0-C6F-6M	22	2	181
HST22X2.5-C6F-6M	22	2.5	232
HST25X1.5-C6F-6M	25	1.5	115
HST25X2.0-C6F-6M	25	2	157
HST25X2.5-C6F-6M	25	2.5	232
HST25X3.0-C6F-6M	25	3	247
HST25X4.0-C6F-6M	25	4	347
HST28X1.5-C6F-6M	28	1.5	102
HST28X2.0-C6F-6M	28	2	139
HST28X2.5-C6F-6M	28	2.5	177
HST28X3.0-C6F-6M	28	3	217
HST30X2.5-C6F-6M	30	2.5	164
HST30X3.0-C6F-6M	30	3	201
HST30X4.0-C6F-6M	30	4	279
HST35X2.0-C6F-6M	35	2	109
HST35X2.5-C6F-6M	35	2.5	139
HST35X3.0-C6F-6M	35	3	169
HST35X5.0-C6F-6M	35	5	303
HST38X3.0-C6F-6M	38	3	155
HST38X4.0-C6F-6M	38	4	213
HST42X3.0-C6F-6M	42	3	139
HST42X4.0-C6F-6M	42	4	190
HST50X3.0-C6F-6M	50	3	115
HST50X5.0-C6F-6M	50	5	201
HST50X6.0-C6F-6M	50	6	247

### Chrome 6 Free, 6 Metre Lengths, Bundles of 10 (Price Each)

0201	OD mm	mm	Pressure Kg/cm <sup>2</sup>
HST4X1.0-C6F-6M	4	1	624
HST6X1.0-C6F-6M	6	1	365
HST6X1.5-C6F-6M	6	1.5	624
HST6X2.0-C6F-6M	6	2	989
HST8X1.0-C6F-6M	8	1	259
HST8X1.5-C6F-6M	8	1.5	423
HST8X2.0-C6F-6M	8	2	624

FLUID POWER

Please refer to our Fluid Power Catalogue for more information



# HYDRAULIC TUBE CLAMPS

Our quality range of Hydraulic Tube Clamps have been manufactured to the highest specifications using quality materials and conforms to DIN 3015 and DIN 3570 Standards.

## The vast range includes:

Light, heavy and double units in sizes ranging from 6mm to 168.3mm. Body materials of polypropylene, polyamide, rubber and aluminium, also with plates and bolts in steel (zinc plated) and stainless steel offering anti-corrosion and fire retardant options. U bolts, pipe saddles, steel clamps and O clamps are available.

The range is tried, tested and used extensively throughout the world's manufacturing facilities and in the mobile plant industry.

If you have any requirements for sizes or types of clamps not shown in the catalogue, please contact a member of our sales team.

## Applications:

- Hydraulics
- Construction
- Agriculture
- Mining
- OEM Machine Building
- Offshore
- Marine
- Automotive Technology
- Machine Tool
- Lubrication Systems



**RBS clamps according to DIN 3015 are DNV certified**

Please refer to our Fluid Power Catalogue for more information



# Walform Machine Hire



Most popular cold forming tube fitting system in the world!

Hassle free hire includes:

- **Walform machine**
- **Tooling**
- **Shipping and Collection**

Hire available now with an order for Eaton Walterscheid compression fittings, tube and clamps

Contact your Account Manager to discuss your requirements

FLUID  
POWER

## Eaton's Walterscheid Trilogy

- Simple final in service assembly with prefabricated tube ends
- Best in class performance
- Maximum system stability & safety
- Superior quality
- Global availability

### WALPRO™



### WALRING™

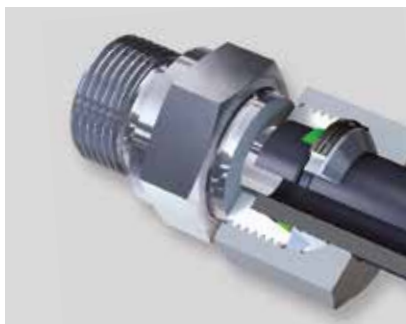

### WALFORM™



Please refer to our Fluid Power Catalogue for more information

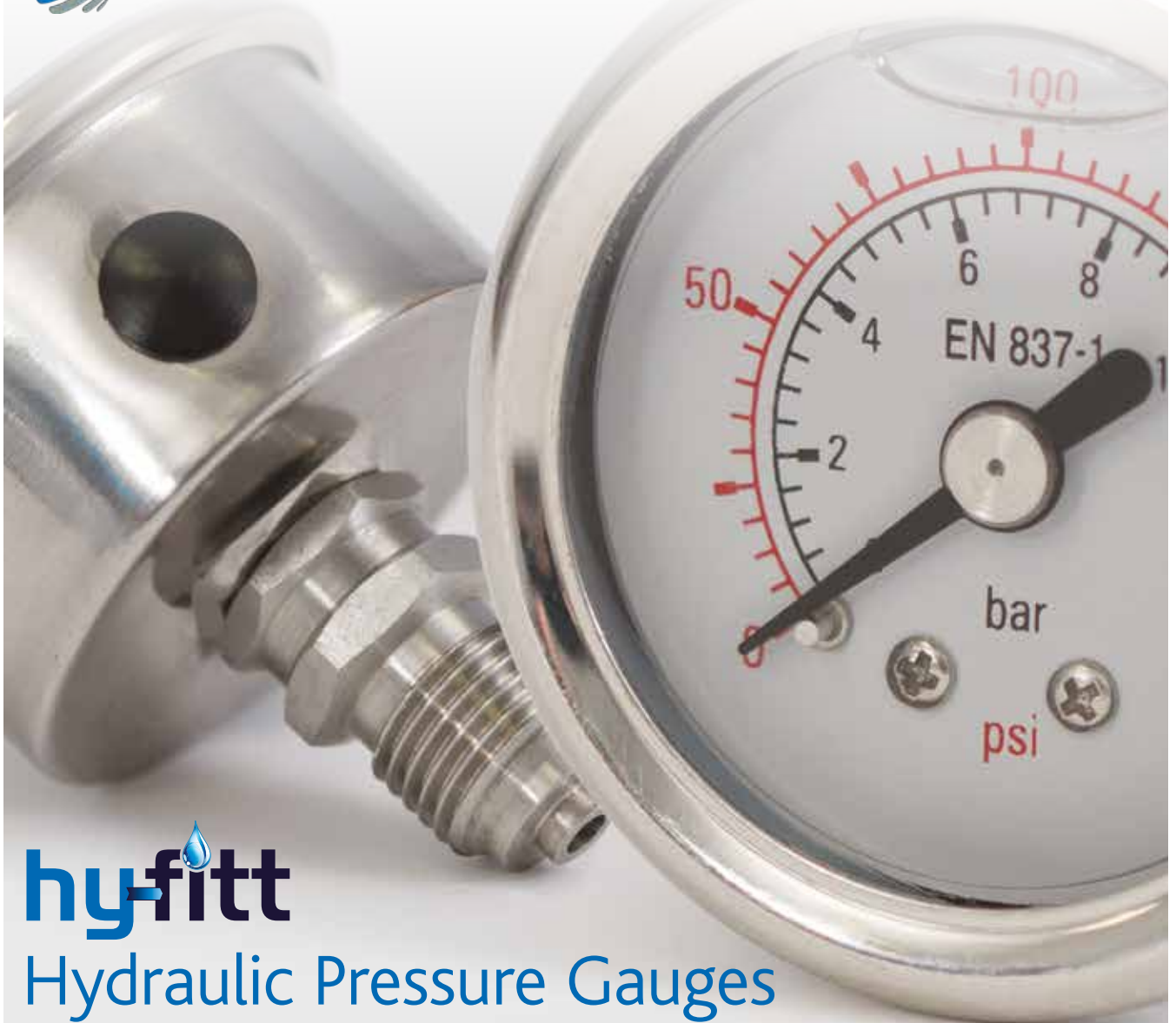

**hyfitt**

## Hydraulic Pressure Gauges

This quality range of hydraulic glycerine-filled pressure gauges have been manufactured to the highest specification using quality materials.

The range includes stainless steel cased to complete stainless steel units with 40mm, 63mm and 100mm dials. Pressures range from 0-1 bar to 0-600 bar, with rear and bottom connections of 1/4" and 1/2" in BSPP and BSPT.

Hy-fitt gauges are tried, tested and used extensively throughout the world's manufacturing facilities and in the mobile plant industry.

*For your peace of mind all gauges can be supplied with a calibration certificate at a nominal charge.*



### Applications:

- Hydraulics
- Construction
- Agriculture
- Mining
- OEM machine building
- Offshore
- Marine
- High pressure water applications
- Service kits

Please refer to our Fluid Power Catalogue for more information



## Pressure Gauges

Air-Pro dry gauges are a market leading range offering a reliable solution for pressure monitoring within pneumatic systems.

Used extensively throughout the world's manufacturing facilities, all units have been 100% pressure tested and inspected, so quality can be guaranteed.

### Applications:

- Construction • Chemical • Agriculture • Offshore • Mining
- Automotive • OEM machine • Rail building • Industrial

Please refer to our Fluid Power Catalogue for more information

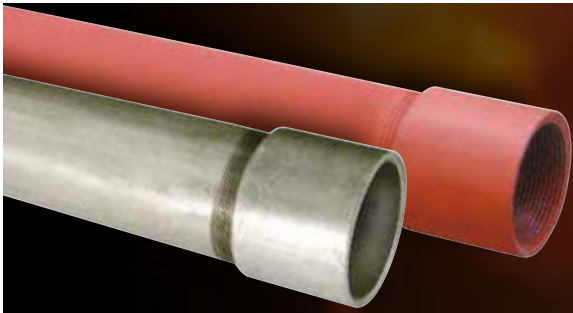

# MASTERS OF MALLEABLE IRON

The most extensive choice of **MALLEABLE IRON** to suit any application and any budget

The choice of fittings is very much dependent on the application, the engineer's reference and budget. With a choice of five brands, large stocks and speedy delivery, there's no need to look any further.

Brand	Duty	Fitting Variations*	Beaded	Banded	Thread	BSI Kitemarked®	Up to 4"	Up to 5"	Up to 6"	WRAS approved	Max Temp	Max Working Pressure	Casting: ISO5922	Threads: ISO 7-1	Manufactured: according to EN 10142 and ISO 49	Design: ISO49, BS EN 10242w	Testing: BS 143 & 1256	Materials: ASTM A-197, ASTM A47
EE	Heavy	26	Y		Male Taper, Female Parallel		Y				300**	25**	Y	Y	Y	Y		

For full technical specification, please contact the manufacturer.

\* Excludes brackets, nuts, flanges, plates and rings.

\*\* Maximum temperature +120°C at maximum working pressure of 20 bar.

## Beaded Range

- Male Taper, Female Parallel – EN10226-1
- Available in black or galvanised finish
- Heavy duty ranges manufactured in accordance with EN 10142

### Parallel Pipe Thread to EN10226-1 Standard

- 55° thread angle

### BS EN 10241 from K-Line Connect

- From 1/8" to 4" thread
- Lengths up to 300mm

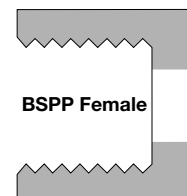
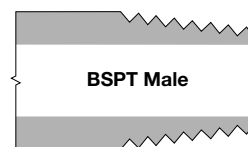

Please refer to our Fluid Power Catalogue for more information

## CAMOZZI AUTOMATION YOUR BEST CHOICE FOR MULTI-TECHNOLOGY SOLUTIONS

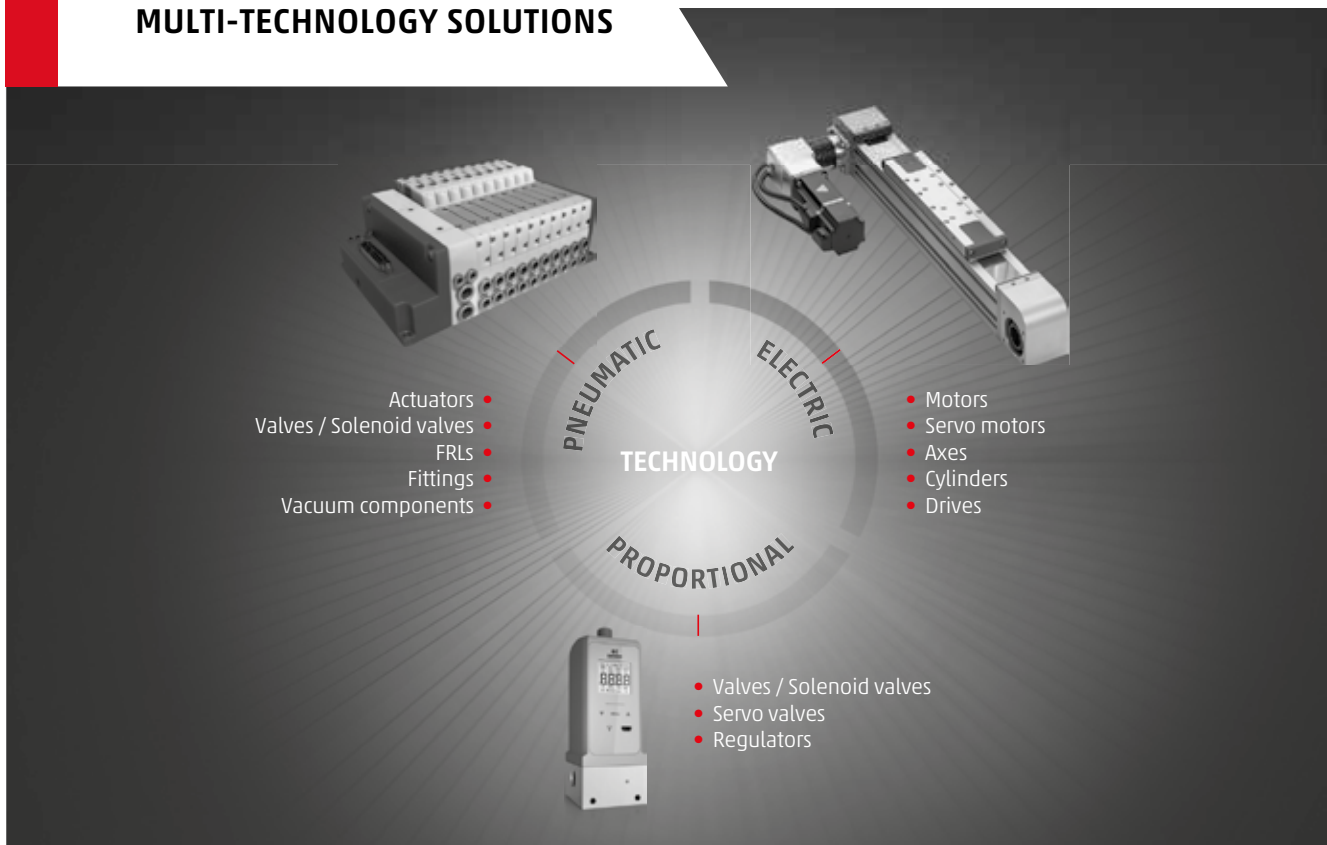

### More than just pneumatics

Camozzi's multi-technological approach makes it possible to offer an optimal solution for every application by choosing from the best pneumatic, electric and proportional technologies available.

This process requires a depth of expertise that not only addresses both the characteristics of technologies and products, but also considers the functional requirements of the end application.



INDUSTRIAL AUTOMATION



LIFE SCIENCE



TRANSPORTATION



## Series 16, 23, 24 and 25 Mini-Cylinders

Single-acting and double-acting - CETOP RP52-P DIN/ISO 6432

Series 16:  $\varnothing$  8, 10, 12 mm

Series 23:  $\varnothing$  16, 20, 25 mm - magnetic, auto-cushioned

Series 24:  $\varnothing$  16, 20, 25 mm - magnetic

Series 25:  $\varnothing$  16, 20, 25 mm - magnetic cushioned

**SAME DAY**  
CYLINDER  
SERVICE



\*Series 23 not currently included

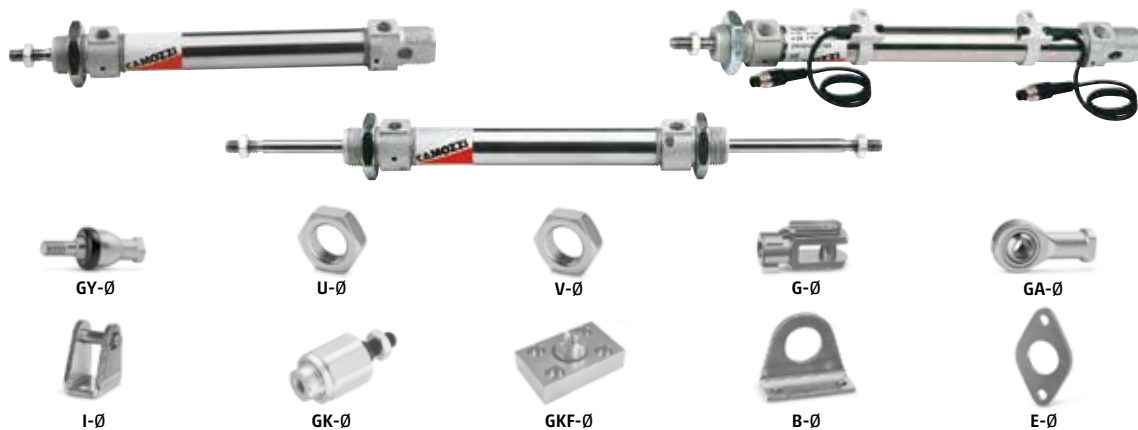

### CODING EXAMPLE

<b>24</b>	<b>N</b>	<b>2</b>	<b>A</b>	<b>16</b>	<b>A</b>	<b>100</b>	<b>-</b>
<b>24</b>	<b>SERIES:</b> 16 = non-magnetic 23 = magnetic, auto-cushioning 24 = magnetic 25 = magnetic adjustable cushioning			<b>16</b>	<b>BORE:</b> 8, 10, 12, 16, 20, 25mm		
<b>N</b>	<b>VERSION:</b> N = standard			<b>A</b>	<b>TYPE OF BRACKET:</b> A = standard (screw with ring + lock nut for rod) RL = cylinder with rod lock $\varnothing$ 20 - $\varnothing$ 25		
<b>2</b>	<b>OPERATION:</b> 1 = single-acting (front spring) 2 = double-acting 3 = double-acting (through rod) 7 = single-acting (through rod)			<b>100</b>	<b>STROKE:</b> (see table)		
<b>A</b>	<b>MATERIALS:</b> A = rolled stainless steel AISI 303 rod, stainless steel AISI 304 tube, anodized AL end-blocks			<b>-</b>	<b>SPECIAL:</b> to be specified V = Rod Seal Viton W = all seals in FKM, +130°C (for series 25 only) ( _ _ ) = extended rod _ _ _ mm		

FLUID POWER

### STANDARD STROKES FOR MINICYLINDERS SERIES 16-23-24-25

- Double-acting
- ✱ Single-acting

standard strokes		10	25	40	50	80	100	125	160	200	250	300	320	400	500
series	$\varnothing$														
16	8	✱	✱	✱	✱										
16	10	✱	✱	✱	✱										
16	12	✱	✱	✱	✱										
24	16	✱	✱	✱	✱										
24	20	✱	✱	✱	✱										
24	25	✱	✱	✱	✱										
23/25	16														
23/25	20														
23/25	25														



## Series 61 Cylinders - Aluminium Profile

ISO 15552 - DIN/ISO 6431 - VDMA 24562

Single and double-acting, magnetic, cushioned. Standard, low friction, low temperatures and tandem versions

∅ 32 - 40 - 50 - 63 - 80 - 100 - 125mm

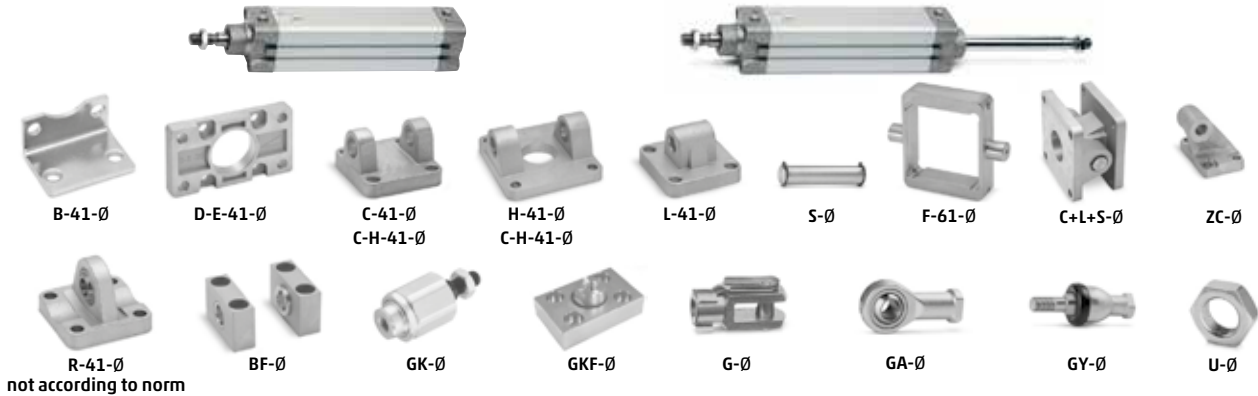

### CODING EXAMPLE

<b>61</b>	<b>M</b>	<b>2</b>	<b>P</b>	<b>050</b>	<b>A</b>	<b>0200</b>	<b>-</b>
-----------	----------	----------	----------	------------	----------	-------------	----------

<b>61</b>	SERIES: 61 = from ∅32 - 125 DIN/ISO 15552	<b>050</b>	BORE: 32, 40, 50, 63, 80, 100, 125mm
<b>M</b>	VERSION: M = magnetic N = non magnetic L = Low friction, magnetic	<b>A</b>	CONSTRUCTION: A = standard with rod nut RL = cylinder with rod lock
<b>2</b>	OPERATION: 1 = single-acting (front spring) 2 = double-acting (front and rear cushions) 3 = double-acting (no cushion) 4 = double-acting (rear cushions) 5 = double-acting (front cushion) 6 = double-acting (through-rod with front and rear cushions) 7 = single-acting (through-rod)	<b>0200</b>	STROKE: (see table)
<b>P</b>	MATERIALS: P = rolled stainless steel rod, AISI 420B anodised profile aluminium tube NBR seals - rod seals polyurethane, nuts and tie-rods zinc-plated steel (See full technical catalogue for all options)		<ul style="list-style-type: none"> <li>= standard</li> <li>V = FKM rod seal</li> <li>N = tandem</li> <li>R = NBR rod seal</li> <li>W = all FKM seals +130°C</li> <li>C = PU coated cylinder. Colour: Grey*</li> <li>L = low friction version without rod seal (rear supply only)**</li> <li>( _ _ ) = extended piston rod _ _ _ mm</li> <li>G = with brass rod scraper (chrome plated stainless steel AISI 420B rod, NBR rod seal) [∅ 125 excepted]</li> </ul> <p>*Version C: available on request. ***The possibility to order the cylinder without piston rod seal, further reduces the friction force.</p>

61M2P = standard version in stock (32 - 100)

Note: All cylinder are supplied with rod nuts. The accessories are supplied separately

### STANDARD STROKES FOR CYLINDERS SERIES 61

- Double-acting (standard and low friction versions)  
Other strokes up to 2500 mm are available on request
- \* Single-acting (standard versions)

standard strokes	∅	25	50	75	80	100	125	150	160	200	250	300	320	400	500
32	■*	■*	■*	■	■	■	■	■	■	■	■	■	■	■	■
40	■*	■*	■*	■	■	■	■	■	■	■	■	■	■	■	■
50	■*	■*	■*	■	■	■	■	■	■	■	■	■	■	■	■
63	■*	■*	■*	■	■	■	■	■	■	■	■	■	■	■	■
80	■*	■*	■*	■	■	■	■	■	■	■	■	■	■	■	■
100		■*	■*	■	■	■	■	■	■	■	■	■	■	■	■
125		■	■	■	■	■	■	■	■	■	■	■	■	■	■

FLUID POWER

## Series 63 Cylinders - ISO 15552

Single and double-acting, magnetic, cushioned.  
Standard, low friction, high and low temperatures  
Ø 32, 40, 50, 63, 80, 100, 125 mm.

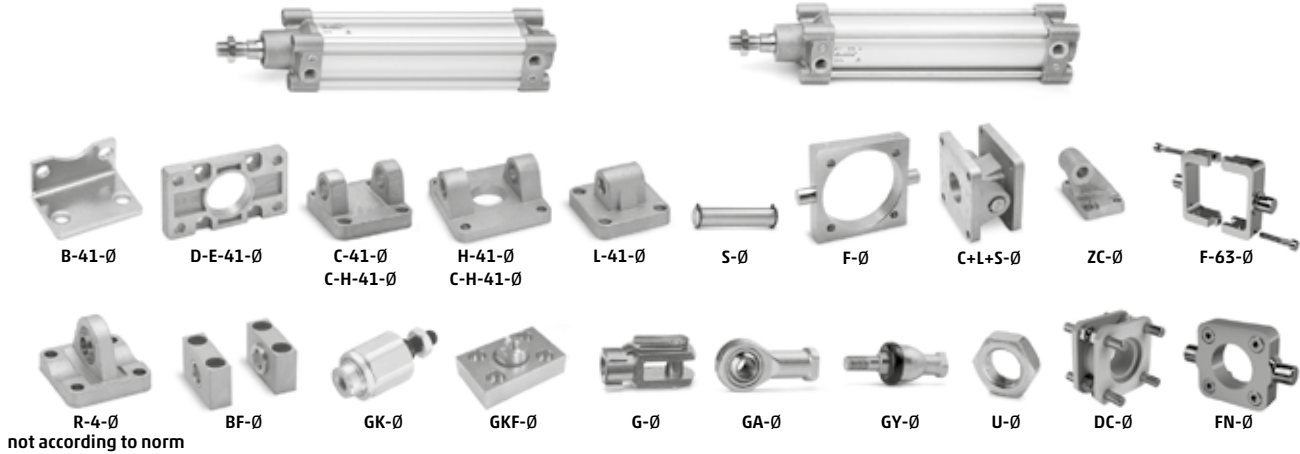

### CODING EXAMPLE

<b>63</b>	<b>M</b>	<b>P</b>	<b>2</b>	<b>C</b>	<b>050</b>	<b>A</b>	<b>0200</b>	<b>W</b>				
-----------	----------	----------	----------	----------	------------	----------	-------------	----------	--	--	--	--

<b>63</b>	SERIES: 63	<b>W</b>	TEMPERATURE RANGE: = standard (-20°C/+80°C) W = high temperatures (150°C) Z = low temperatures (-40°C) Y = low temperatures (-50°C)
<b>M</b>	VERSION: M = standard, magnetic V = smooth movement (low speed), magnetic L = Low friction, magnetic		
<b>P</b>	CONSTRUCTION: T = round tube P = profile		RESISTANCE TO CORROSION: = standard C1 = rod nut AISI 304 stainless steel, rod AISI 304 stainless steel C2 = end cap treated screws (profile) or AISI 303 tie-rods and AISI 420B tie-rods (round tube) C3 = C2 + AISI 316 rod nut, AISI 316 rod C4 = C1 + C2 C5 = C3 + end caps with triple protection
<b>2</b>	OPERATION: 1 = single-acting, front spring 2 = double-acting 6 = double-acting, through-rod 7 = single-acting, through-rod 9 = single-acting, rear spring		
<b>C</b>	CUSHIONING: N = no cushioning (mechanical endstops) C = cushioning on both sides F = front cushioning R = rear cushioning		ROD VARIATIONS: = standard (male rod thread) F = female rod thread K = end caps with Kanigen treatment L = without rod seal (rear air inlet only) V = FKM rod seal R = NBR rod seal U = unlubricated operation H = hydrolytic environment A = use in food and other frequent washdown applications G = dry and dusty environments (with brass rod scraper and chrome-plated stainless steel AISI 420B rod) B = cylinder with NBR bellow rod protection B2 = cylinder with through rod and NBR bellow rod protection on both sides (___) = rod longer than ___mm
<b>050</b>	BORE: 32, 40, 50, 63, 80, 100, 125mm		
<b>A</b>	CONSTRUCTION: A = standard with rod nut RL = cylinder with rod lock DC = back to back cylinder with DC accessory (X1/X2) TR = back to back cylinder for round tube (X1/X2) F = cylinder with centre trunnion		
<b>0200</b>	STROKE: = standard N = tandem / = more positions X1/X2 (X1<X2)		OTHER: P = cylinder with RAL 7035 polyurethane coating
			CERTIFICATIONS: EX = ATEX

FLUID POWER

## STANDARD STROKES FOR CYLINDERS SERIES 63

- Double-acting, (standard, low friction, high/low temperatures)
- ★ Single-acting front spring (standard, high/low temperature)
- ▲ Single-acting, rear spring (standard, high/low temperatures)

standard strokes	25	50	75	80	100	125	150	160	200	250	300	320	400	500
32	■ ★ ▲	■ ★ ▲	■ ★	■	■	■	■	■	■	■	■	■	■	■
40	■ ★ ▲	■ ★ ▲	■ ★	■	■	■	■	■	■	■	■	■	■	■
50	■ ★ ▲	■ ★ ▲	■ ★	■	■	■	■	■	■	■	■	■	■	■
63	■ ★ ▲	■ ★ ▲	■ ★	■	■	■	■	■	■	■	■	■	■	■
80	■ ★ ▲	■ ★ ▲	■ ★	■	■	■	■	■	■	■	■	■	■	■
100		■ ★ ▲	■ ★	■	■	■	■	■	■	■	■	■	■	■
125		■ ★ ▲	■ ★	■	■	■	■	■	■	■	■	■	■	■

## UK Cylinder Service



### Reduce Lead Times for Pneumatic Cylinders

- Built the same or next day
- Includes many cylinder types

## Actuated Valve Assemblies

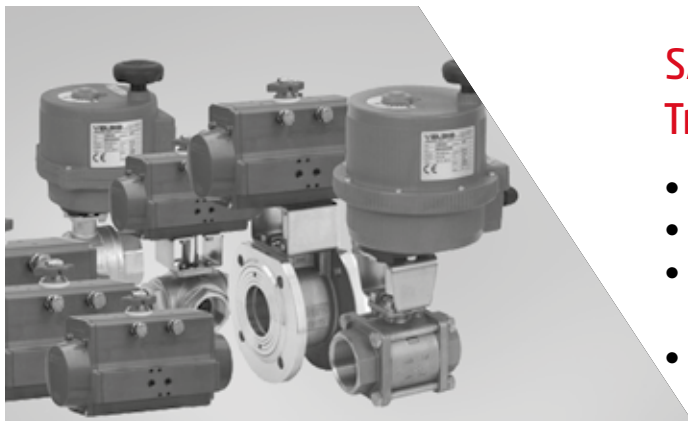

### SAME DAY DESPATCH Try the service today!

- Pneumatic and Electric Actuators
- Single and Double Acting
- Comprehensive Range of Valves (Ex-Stock)
- Fully Assembled and Tested

FLUID POWER

# Series 4 Valves and Solenoid Valves

3/2, 5/2 and 5/3 way CC CO CP

Connections: 1/8, 1/4 and 1/2. Full range available.

438-015-22*		438-011-22*		458-015-22*		458-011-22*	
*Coil sold separately							
434-015-22*		434-011-22*		454-015-22*		454-011-22*	
*Coil sold separately							
438-35		458-35		438-33		458-33	
434-35		454-35		434-33		454-33	

## Full Range Available:

Valve Islands  
- UK Assembly



Mechanical and  
Manual Valves



Flow Control Valves



Automatic Valves



FLUID  
POWER

## Series MX Filter-Regulators

Connections: MX2=3/8, 1/2, 3/4 MX3=3/4, 1. Modular  
Bowl with technopolymer cover and bayonet-type mounting



### CODING EXAMPLE

**MX 2 - 1/2 - FR 0 0 0 4 M - LH**

<b>MX</b> Series: MX	<b>0</b> DRAINING OF CONDENSATE: 0 = semi-automatic manual drain (standard - only for polymer bowl) 3 = automatic drain 5 = depressuring drain, protected (only for polymer bowl) 8 = without drain with connection 1/8
<b>2</b> SIZE: 2 = 3/8 - 1/2 - 3/4 3 = 3/4 - 1	<b>0</b> OPERATING PRESSURE: 0 = 0.5 - 10 bar (standard) 4 = 0 - 4 bar 7 = 0.5 - 7 bar (MX2 only)
<b>3/8</b> CONNECTIONS: 3/8, 1/2, 3/4, 1	<b>4</b> PRESSURE GAUGE: 0 = without pressure gauge 2 = with built-in pressure gauge 0-6 and working pressure 0-4 bar 3 = with built-in pressure gauge 0-10 and working pressure 0-7 bar (MX2 only) 4 = with built-in pressure gauge 0-12 and working pressure 0.5 - 10 bar (standard)
<b>FR</b> FILTER REGULATOR	
<b>0</b> FILTERING ELEMENT WITH DESIGN TYPE: 0 = 25µm with relieving (standard) 1 = 5µm with relieving 2 = 25µm without relieving 3 = 5µm without relieving	<b>M</b> TYPE OF BOWL: = polymer (standard) M = metal (only for MX2-1/2 and MX3-1)
	<b>LH</b> FLOW DIRECTION: = from left to right (standard) LH = from right to left

FLUID POWER

## Air Treatment Box Sets



### Reduce costs and save time

- 1/2 & 3/8
- Removes Contaminants
- Controls Pressure
- Extends Component Service Life
- Increased Safety

## Series MX Filters

Connections: MX2=3/8, 1/2, 3/4  
 MX3=3/4, 1. Modular  
 Bowl with technopolymer cover and  
 bayonet-type mounting



### CODING EXAMPLE

**MX** | **2** | - | **1/2** | - | **F** | **0** | **0** | **M** | **1** | - | **LH**

<b>MX</b>	SERIES: MX	<b>0</b>	DRAINING OF CONDENSATE: 0 = semi-automatic manual drain (standard - only for polymer bowl) 3 = automatic drain 5 = depressuring drain, protected (only for polymer bowl) 8 = without drain with connection 1/8
<b>2</b>	SIZE: 2 = 3/8 - 1/2 - 3/4 3 = 3/4 - 1	<b>M</b>	TYPE OF BOWL: = polymer (standard) M = metal (only for MX2-1/2 and MX3-1)
<b>1/2</b>	CONNECTIONS: 3/8, 1/2, 3/4, 1	<b>1</b>	VISUAL BLOCKAGE INDICATOR: = not present 1 = present
<b>F</b>	FILTER	<b>LH</b>	FLOW DIRECTION: = from left to right (standard) LH = from right to left
<b>0</b>	FILTERING ELEMENT: 0 = 25µm (standard) 1 = 5µm		

## Series MX Pressure Regulators

Connections: MX2=3/8, 1/2, 3/4  
 MX3=3/4, 1. Manifold Connections: 1/2  
 (MX2 only)  
 Modular - Available with built-in  
 pressure gauges or with connection for  
 external gauge



### CODING EXAMPLE

**MX** | **2** | - | **3/8** | - | **R** | **0** | **0** | **4** | - | **LH**

<b>MX</b>	SERIES: MX	<b>0</b>	DESIGN TYPE: 0 = relieving (standard) 1 = without relieving 2 = relieving, with by-pass valve (only regulator) 3 = without relieving, with by-pass valves (only regulator)
<b>2</b>	SIZE: 2 = 3/8 - 1/2 - 3/4 3 = 3/4 - 1	<b>4</b>	PRESSURE GAUGE: 0 = without pressure gauge (with threaded connection for gauges) 2 = with built-in pressure gauge 0-6 and working pressure 0 - 4 bar 3 = with built-in pressure gauge 0-10 and working pressure 0 - 7 bar (MX2 only) 4 = with built-in pressure gauge 0-12 and working pressure 0.5 - 10 bar (standard)
<b>3/8</b>	CONNECTIONS: 3/8, 1/2, 3/4, 1	<b>LH</b>	FLOW DIRECTION: = from left to right (standard) LH = from right to left
<b>R</b>	TYPE OF REGULATOR: R = pressure regulator M = manifold pressure regulator (MX2 1/2 only)		
<b>0</b>	OPERATING PRESSURE: 0 = 0.5 - 10 bar (standard) 4 = 0 - 4 bar 7 = 0.5 - 7 bar (MX2 only)		

## Series MX Lubricators

Connections: MX2=3/8, 1/2, 3/4  
 MX3=3/4, 1. Modular  
 Bowl with technopolymer cover and  
 bayonet-type mounting



### CODING EXAMPLE

**MX** | **2** | - | **1/2** | - | **L** | **00** | **M** | - | **LH**

<b>MX</b>	SERIES: MX	<b>00</b>	DESIGN TYPE: 00 = atomized oil
<b>2</b>	SIZE: 2 = 3/8 - 1/2 - 3/4 3 = 3/4 - 1	<b>M</b>	TYPE OF BOWL: = polymer (standard) M = metal (for MX2-1/2 and mx3-1 only)
<b>1/2</b>	CONNECTIONS: 3/8, 1/2, 3/4, 1	<b>LH</b>	FLOW DIRECTION: = from left to right (standard) LH = from right to left
<b>L</b>	LUBRICATOR		

FLUID  
POWER

## Series MD Filter/Regulators

Connections with interchangeable cartridges: threaded (1/8, 1/4, 3/8) or integrated with super-rapid fitting for tube with  $\varnothing$  6, 8 and 10mm. Modular assembly. Bowl with technopolymer cover and bayonet-type mounting.



### CODING EXAMPLE

<b>MD</b>	<b>1</b>	-	<b>FR</b>	<b>0</b>	<b>0</b>	<b>0</b>	<b>0</b>	-	<b>1/8</b>
-----------	----------	---	-----------	----------	----------	----------	----------	---	------------

<b>MD</b> SERIES: MD	<b>0</b> DRAINING OF CONDENSATE: 0 = semi-automatic manual drain (standard) 5 = depressuring drain, protected 8 = no drain with connection 1/8
<b>1</b> SIZE: 1 = 42mm	<b>0</b> OPERATING PRESSURE: 0 = 0.5 - 10 bar (standard) 2 = 0 - 2 bar 4 = 0 - 4 bar 7 = 0.5 - 7 bar
<b>FR</b> FILTER REGULATOR	<b>0</b> PRESSURE GAUGE: 0 = without pressure gauge (1/8 Connection)
<b>0</b> FILTERING ELEMENT WITH DESIGN TYPE: 0 = 25 $\mu$ m with relieving (standard) 1 = 5 $\mu$ m with relieving 2 = 25 $\mu$ m without relieving 3 = 5 $\mu$ m without relieving 4 = 25 $\mu$ m with relieving version VS 5 = 5 $\mu$ m with relieving version VS 6 = 25 $\mu$ m without relieving version VS (for semiautomatic-manual drain only) 7 = 5 $\mu$ m without relieving version VS (for semiautomatic-manual drain only)	<b>1/8</b> CONNECTIONS (IN/OUT*): = no connection 1/8, 1/4, 3/8, 6, 8, 10

## Series MD Filters

Connections with interchangeable cartridges: threaded (1/8, 1/4, 3/8) or integrated with super-rapid fitting for tube with  $\varnothing$  6, 8 and 10mm. Modular assembly. Bowl with technopolymer cover and bayonet-type mounting.



### CODING EXAMPLE

<b>MD</b>	<b>1</b>	-	<b>F</b>	<b>0</b>	<b>0</b>	<b>0</b>	-	<b>1/8</b>
-----------	----------	---	----------	----------	----------	----------	---	------------

<b>MD</b> SERIES: MD	<b>0</b> DRAINING OF CONDENSATE: 0 = semi-automatic manual drain (standard) 5 = depressuring drain, protected 8 = no drain with connection 1/8
<b>1</b> SIZE: 1 = 42mm	
<b>F</b> FILTER	<b>0</b> VISUAL INDICATOR: 0 = Without indicator 1 = With indicator
<b>0</b> FILTERING ELEMENT: 0 = 25 $\mu$ m (standard) 1 = 5 $\mu$ m	<b>1/8</b> CONNECTIONS (IN/OUT*): = no connection 1/8, 1/4, 3/8, 6, 8, 10

Full range of accessories available

## Series MD Pressure Regulators

Connections with interchangeable cartridges: threaded (1/8, 1/4, 3/8) or integrated with super-rapid fitting for tube with  $\varnothing$  6, 8 and 10mm. Versions: single, combined with other functions, Manifold.



### CODING EXAMPLE

<b>MD</b>	<b>1</b>	-	<b>R</b>	<b>T</b>	<b>0</b>	<b>0</b>	-	<b>1/4</b>	-
-----------	----------	---	----------	----------	----------	----------	---	------------	---

<b>MD</b> SERIES: MD	<b>0</b> DESIGN TYPE: 0 = self-relieving 1 = non-relieving 2 = relieving high relief flow 3 = non-relieving high relief flow
<b>1</b> SIZE: 1 = 42mm	<b>0</b> PRESSURE GAUGE: 0 = without pressure gauge (1/8 Connection)
<b>R</b> R = pressure regulator M = manifold pressure regulator	<b>1/4</b> CONNECTIONS (IN/OUT*): = no connection 1/8, 1/4, 3/8, 6, 8, 10
<b>T</b> OPERATING PRESSURE: 0 = 0.5 - 10 bar (standard) 2 = 0 - 2 bar 4 = 0 - 4 bar 7 = 0.5 - 7 bar T = calibrated** B = locked**	



## Series 6000 Super-Rapid Fittings for Plastic Tubes

Tube external diameters: 3, 4, 5, 6, 8, 10, 12, 14, 16 mm

Threaded connections: metric (M3, M5, M6, M7), BSP (1/8, 1/4, 3/8, 1/2, 3/4), BSPT (1/8, 1/4, 3/8, 1/2)

Super-rapid fittings Series 6000 are available in 35 different models.  
 Super-rapid fittings Series 6000 Micro are available in 14 different models.  
 Connection and disconnection of the tube can be repeated several times and can be performed without the use of tools.  
 The extractable internal collet allows the sealing ring (O-ring) to be easily replaced if it is damaged or in case of wear of the rubber compound.

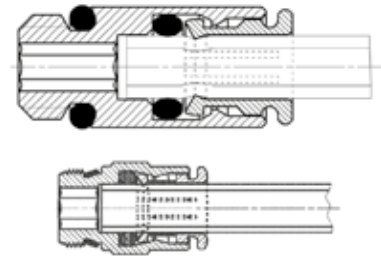

Sprint\*



Note:  
with O-Ring



Male Connector		BSP Male Connector		BSP Male Connector		BSP Female Connector	
S6510 4-1/8	S6510 10-1/4	6512 3-M3 <sup>o</sup>	6512 4-M5	6512 8-3/8	6463 4-M5		
S6510 4-1/4	S6510 10-3/8	6512 3-M5*	6512 4-M6	6512 10-1/4	6463 4-1/8		
S6510 5-1/8	S6510 10-1/2	6512 4-M7-M*	6512 4-1/8	6512 10-3/8	6463 5-1/8		
S6510 5-1/4	S6510 12-1/4	6512 4-1/8-M*Y	6512 4-1/4	6512 10-1/2	6463 6-1/8		
S6510 6-1/8	S6510 12-3/8	6512 6-M7-M*	6512 5-M5	6512 12-1/4	6463 6-1/4		
S6510 6-1/4	S6510 12-1/2	6512 6-1/8-M*Y	6512 6-M5	6512 12-3/8	6463 8-1/8		
S6510 6-3/8	S6510 14-3/8	6512 8-1/8-M*Y	6512 6-M6	6512 12-1/2	6463 8-1/4		
S6510 8-1/8	S6510 14-1/2	6512 10-1/4-M*	6512 6-1/8	6512 14-3/8	6463 10-1/4		
S6510 8-1/4	S6510 16-1/2		6512 6-1/4	6512 14-1/2			
S6510 8-3/8	S6510 16-3/4		6512 8-1/8	6512 16-1/2			
S6510 8-1/2			6512 8-1/4				

<sup>o</sup> = with mod. 2661 assembled  
 \* = with O-ring assembled  
 \*Y = with O-ring assembled  
 It can be connected also to valve islands Series Y



Note:  
with O-Ring

Sprint\*



Sprint\*



Swivel Male Elbow		BSP Swivel Male Elbow		Fixed Male Elbow		Long Swivel Male Elbow	
S6520 4-1/8	S6520 8-1/2	6522 4-M5	6522 8-3/8	S6500 4-1/8	6525 6 -1/8		
S6520 4-1/4	S6520 10-1/4	6522 4-1/8	6522 10-1/4	S6500 4-1/4	6525 6 -1/4		
S6520 5-1/8	S6520 10-3/8	6522 4-1/4	6522 10-3/8	S6500 5-1/8	6525 8 -1/8		
S6520 5-1/4	S6520 10-1/2	6522 5-M5	6522 10-1/2	S6500 5-1/4	6525 8 -1/4		
S6520 6-1/8	S6520 12-1/4	6522 6-M5	6522 12-1/4	S6500 6-1/8			
S6520 6-1/4	S6520 12-3/8	6522 6-1/8	6522 12-3/8	S6500 6-1/4			
S6520 6-3/8	S6520 12-1/2	6522 6-1/4	6522 12-1/2	S6500 8-1/8			
S6520 8-1/8	S6520 14-3/8	6522 8-1/8	6522 14-3/8	S6500 8-1/4			
S6520 8-1/4	S6520 14-1/2	6522 8-1/4	6522 14-1/2	S6500 8-3/8			
S6520 8-3/8				S6500 10-1/4			
				S6500 10-3/8			
				S6500 12-1/4			
				S6500 12-3/8			



BSP Fix Male Elbow

6501 4 -M5

With mod. 2661 assembled

FLUID  
POWER

### Full Range Available:

Super-Rapid Compact Fittings in Technopolymer Series 7000



Compact

Pipe Fittings Series 2000 / BSPT Adaptors





Sprint\*



Swivel Male Tee	
S6430 4-1/8	S6430 10-1/4
S6430 5-1/8	S6430 10-3/8
S6430 5-1/4	S6430 10-1/2
S6430 6-1/8	S6430 12-1/4
S6430 6-1/4	S6430 12-3/8
S6430 8-1/8	S6430 12-1/2
S6430 8-1/4	S6430 14-1/2
S6430 8-3/8	



BSP Swivel Male Tee	
6432 4 -M5	
6432 4 -1/8	
6432 5 -M5	
6432 6 -1/8	
6432 6 -1/4	
6432 8 -1/8	
6432 8 -1/4	
6432 8 -3/8	
6432 10-1/4	
6432 10-3/8	
6432 12-1/4	
6432 12-3/8	

Sprint\*



Lateral Swivel Male Tee	
S6440 4-1/8	
S6440 5-1/8	
S6440 6-1/8	
S6440 6-1/4	
S6440 8-1/8	
S6440 8-1/4	
S6440 8-3/8	
S6440 10-1/4	
S6440 10-3/8	
S6440 12-3/8	
S6440 14-1/2	



Note:  
with O-Ring

Lateral BSP Swivel Male Tee	
6442 4 -M5	
6442 4 -1/8	
6442 5 -M5	
6442 6 -1/8	
6442 6 -1/4	
6442 8 -1/8	
6442 8 -1/4	
6442 8 -3/8	
6442 10-1/4	
6442 10-3/8	
6442 12-1/4	
6442 12-3/8	

Sprint\*



BSP Male Y	
6451 4 -M5*	
6451 6 -M5*	

Swivel Male Y	
S6450 4-1/8	
S6450 6-1/8	
S6450 8-1/8	
S6450 8-1/4	



Note:  
with O-Ring

BSP Swivel Single Banjo	
6622 4 -M5	
6622 4 -1/8	
6622 6 -1/8	
6622 6 -1/4	
6622 8 -1/8	
6622 8 -1/4	
6622 10-1/4	



Note:  
with O-Ring

BSP Swivel Double Banjo	
6632 4 -1/8	
6632 6 -1/8	
6632 6 -1/4	
6632 8 -1/8	
6632 8 -1/4	
6632 10-1/4	



Double Banjo	
6620 4 -M5°	
6620 4-1/8*	
6620 6-1/8*	
6620 6-1/4*	
6620 8-1/8*	
6620 8-1/4*	



Banjo Bolts	
1631 01...	
1631 02...	
1631 03...	

01... = Single Banjo Stem  
02... = Double Banjo Stem  
03... = Triple Banjo Stem

Assembly with Mod.

° = SCU, SVU, SCO...

\* = 1631, 1635, SCU, SVU, SCO...

\* = non swivel model with gasket

FLUID  
POWER

Sprint\*



Single Banjo	
6610 4 -M5*	6610 6 -1/8*
6610 4 -M6°	6610 6-1/4*
6610 4-1/8*	6610 8-1/8*
6610 5 -M5*	6610 8-1/4*
6610 5 -M6°	6610 8-3/8*
6610 5-1/8*	6610 10-1/4**
6610 6 -M5*	6610 10-3/8**
6610 6 -M6°	6610 12-1/2^

Assembly with Mod.

• = 1631

° = SCU, SVU, SCO...

\* = 1631, 1635, SCU, SVU, SCO...

\*\* = 1635, SCU, SVU, SCO...

^ = 1635



\*Note:  
with O-Ring

Male Adaptor	
6811 4 -M5*	6811 8 -1/8
6811 4 -1/8	6811 8 -1/4
6811 5 -1/8	6811 10-1/4
6811 5 -1/4	6811 10-3/8
6811 6 -1/8	6811 12-3/8
6811 6 -1/4	6811 14-1/2

Sprint\*



45° Male Elbow	
S6110 6-1/8	
S6110 6-1/4	
S6110 8-1/8	
S6110 8-1/4	
S6110 8-3/8	
S6110 10-1/4	
S6110 10-3/8	
S6110 10-1/2	
S6110 12-1/4	
S6110 12-3/8	
S6110 12-1/2	

## Full Range Available:

Tubing & Accessories



Series 5000 Quick Release Couplings



# Ball Valves & Actuators

## Series 29 Mini Ball Valves for Pneumatics and Industrial Fluids

Tube external diameters: 4, 6 and 8mm  
Threads: BSP (1/8, 1/4, 3/8, 1/2)

**Mini ball valves, MINI version - 2948**



2/2 in-line with Push-in Collet
2948 4
2948 6
2948 8

**Mini ball valves, MINI version - 2947**



2/2 in-line with Push-in Collet, Male BSPT Threads
2947 1/8-4
2947 1/8-6
2947 1/8-8
2947 1/4-4
2947 1/4-6
2947 1/4-8

**Mini ball valves, MINI version - 2946**



2/2 in-line with Push-in Collet, Female BSPP Threads
2946 1/8-4
2946 1/8-6
2946 1/8-8
2946 1/4-4
2946 1/4-6
2946 1/4-8

**Mini ball valves, MINI version - 2943**



2/2 in-line, Female-Female BSPP Threads
2943 1/8
2943 1/4

**Mini ball valves, MINI version - 2944**



2/2 in-line, Male BSPT-Female BSPP Threads
2944 1/8-1/8
2944 1/4-1/4

**Mini ball valves, MINI version - 2945**



2/2 in-line, Male BSPT Threads
2945 1/8
2945 1/4

**Mini ball valves, ECO version - 2953**



2/2 in-line, Female-Female BSPP Threads
2953 1/4
2953 3/8
2953 1/2

**Mini ball valves, ECO version - 2954**



2/2 in-line, Male BSPP-Female BSPP Threads
2954 1/4-1/4
2954 3/8-3/8
2954 1/2-1/2

**Mini ball valves, Butterfly version - 2963**



2/2 in-line, Female-Female BSPP Threads
2963 1/4
2963 3/8
2963 1/2

**Mini ball valves, Butterfly version - 2964**



2/2 in-line, Male BSPP-Female BSPP Threads
2964 1/4-1/4
2964 3/8-3/8
2964 1/2-1/2

**Mini ball valves, 3/2-way version - 2973**



3/2 in-line, Male BSPP-Female BSPP Threads
2973 1/4
2973 3/8
2973 1/2

**Mini ball valves, 3/2-way version - 2974**



3/2 in-line, Male BSPP-Female BSPP Threads
2974 1/4-1/4
2974 3/8-3/8
2974 1/2-1/2

FLUID POWER

## Mini Ball Valves

Suitable for most non-corrosive liquids and gases including air, water and fuels. Operating pressure 10 bar (147psi). Operating temperature -20°C to +90°C.

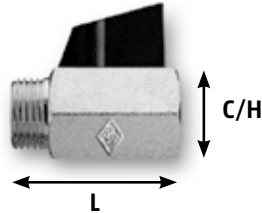
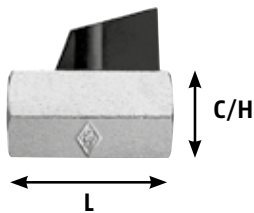

Female/Female	L	C/H
3830 1/8	41	21
3830 1/4	41	21
3830 3/8	41	21
3830 1/2	46	25

Male/Female	L	C/H
3831 1/8	41	21
3831 1/4	41	21
3831 3/8	41	21
3831 1/2	46	25

## Brass Ball Valves - Gas/WRAS Approved

Suitable for most non-corrosive liquids and gases including air, water, solvents and fuels. Operating temperature -20°C to +130°C

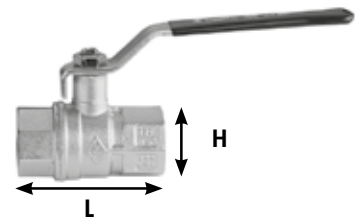

Female/Female	L	H
6273 1/4	51.5	23
6273 3/8	51.5	23
6273 1/2	59	30
6273 3/4	67	36
6273 1	81.5	43.5
6273 1 1/4	94	53
6273 1 1/2	102.4	65
6273 2	123	80

## Economy Stainless Steel Ball Valves Two-Piece Design

2-Piece stainless steel quarter turn ball valves with all wetted parts stainless steel AISI316. Other metal parts in stainless steel AISI304. Available with NPT threads. (Part No 700023)

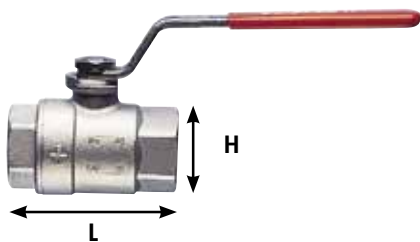

Female/Female	Thread	L	H
70400002	1/4	53.5	30
70400003	3/8	53.5	30
70400004	1/2	60	32.5
70400005	3/4	70	40
70400006	1	79	49
70400007	1 1/4	91	62
70400008	1 1/2	103	75
70400010	2	124	95

## Pneumatically Actuated 2-Way Brass Ball Valves

Full bore, direct mounted actuator, nickel plated brass ball valves (low torque design). Also available in 1/4, 3/8, 2 1/2, 3, 4.



3-Way Option Also Available (L/T Port)

Double Acting	Thread	Bar	Single Acting	Thread	Bar
8P007904	1/2	40	8P008104	1/2	40
8P007905	3/4	40	8P008105	3/4	40
8P007906	1	40	8P008106	1	40
8P007907	1 1/4	40	8P008107	1 1/4	40
8P007908	1 1/2	40	8P008108	1 1/2	40
8P007910	2	40	8P008110	2	40

## Full Range of Accessories Available:

### Limit Switch Box



### Namur 3/2 and 5/2 Solenoid Valves



# PULLERS

Bearing Removal Made Easy



With You

## PULLER KIT FOR DEEP-GROOVE BALL BEARINGS



### APPLICATION

Tool to extract deep groove ball bearings of 10-100mm bore from blind housings.

### ADVANTAGES

Enables easy removal

Part Number:  
TOOL BBPS 10-100 / Ball Bearing Puller Set



## PULLER KITS FOR THE INTERNAL GRIPPING OF THE BORE OF A BEARING



### APPLICATION

Tool to extract tightly fitted bearings from housings by pulling on the internal diameter. Range from 5-100mm

### ADVANTAGES

Comprehensive range of Pullers adjustable to suit your application. Two sets (5-44mm) and (45-100mm)

Part Number:  
TOOL BP Set 5-44 / Bore Puller Set  
TOOL BP Set 45-100 / Bore Puller Set



## SELF-CENTRING HYDRAULIC PULLERS 2/3 ARMS SELF-CENTRING HYDRAULIC PULLERS



### APPLICATION

Tools to enable the extraction of large bearings and other components with an interference fit such as pulleys and gears. Maximum outside diameters ranging from 325 to 680mm.

### ADVANTAGES

Sturdy, compact self-centring pullers with hydraulic assistance to enable dismantling with minimum effort. Convertable from 3 leg to 2 leg.

Part Number:  
TOOL SCHP 4TONS / Self-Center hyd Puller  
> also available in: 12.20 and 30 TONS



**DEWALT**

**DeWalt Industrial Tool Company is an American worldwide manufacturer of professional quality and high-end power tools, hand tools and accessories for the construction, manufacturing and woodworking industries.**



TOOLS

**TOOLBANK**

# STANLEY®

**Since 1843 STANLEY® have been delivering hardworking, innovative and powerful tools that tradespeople can trust and to this day they're here for one reason: to help Pro's get the job done better. As the industry evolves and changes, STANLEY® listen to and work with end-users to develop and hone their tools to suit the needs of the modern pro - helping them to excel in a competitive environment. STANLEY® do it side-by-side with the experts who know more about tools than anyone else: tradespeople. Listening to what they need and creating products together. And it's what makes STANLEY® tools PRO AS STANDARD.**



TOOLS

**TOOLBANK**

# Starrett®

**The L.S. Starrett Company, founded in 1880, manufactures industrial, professional and consumer products which include precision tools, tape measures, levels, electronic gauges, dial indicators, gauge blocks, digital readout measuring tools, granite surface plates, optical projectors, vision systems, co-ordinate measuring machines, vices, M1 lubricant, hacksaw blades, hole saws, band saw blades, circular saw blades, jig and reciprocating saw blades and ground flat stock.**

**In recent years there have been numerous acquisitions and product line expansions in many categories to further penetrate the company's markets.**



**TOOLBANK**

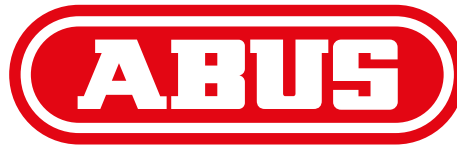

Security Tech Germany

**ABUS was founded in 1924. Initially, it was limited to the manufacture of padlocks. It is family-owned and over the years, its product range has substantially increased, to include: smoke alarms, video surveillance systems, bike and boat security products, alarm systems and locking systems.**

**ABUS operates the final two product segments via its subsidiary companies:**

**Security-Center (alarm and video surveillance systems)  
Schließenanlagen GmbH Pfaffenhain (locking systems),  
SECCOR high security GmbH (electronic locking systems  
and switching devices).**



**TOOLBANK**





**We are one of the top hand tools brands in the UK and Ireland and we've been trading for over 30 years. We have come a long way since 1989 when we started out with just a small range of contractors products. The brand has developed significantly over the years but our core values remain the same, quality products manufactured to tradesman standards at competitive prices. Product innovation and development has been core to our brands ethos, essentially we strive to offer quality products but available at affordable prices.**



TOOLS

**TOOLBANK**



**Designed to meet the competitive expectations of today's professional tool users.**

**Working to a budget doesn't mean it's necessary to have low quality tools that will need replacing frequently.**

**Designed by the research and development team responsible for premium brand, Facom, Expert by Facom provides a range of over 1,600 reliable and cost-effective tools from socketry and wrenches to screwdrivers and pliers.**

**Expert by Facom tools meet all current ISO and DIN standards so you can rest assured they will continue to perform year after year.**



**TOOLBANK**

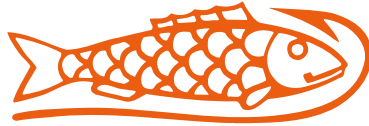

# BAHCO

**Bahco is a pan-European market leading brand of a wide range of professional hand-held tools such as: handsaws, combination spanners, socket spanners, screwdrivers, adjustable wrenches, cutters, files, bandsaws, pruning tools, holesaws, hacksaw frames and blades.**

**Professional craftsmen around the globe use their tools and have done so since 1886 when they first began manufacturing saws and then in 1892 the adjustable wrench. That spirit of innovation continues to flourish within their company.**



## TOOLBANK

**STANLEY**

**BUILT-IN PERFORMANCE™**

# Safety & Workwear

**STANLEY has been committed to providing professionals across the globe with products that are smart, tough, pioneering, and up to the task. Every STANLEY tool is created to help you work better, smarter and faster. Our discovery teams work side-by-side with real tradespeople to see how they work and identify ways to help improve their performance. This means that our workwear comes with something special - understanding. From the boots that protect your feet to the trousers and jackets that keep you warm and comfortable, we create workwear that helps you be your best. Why do we do it? Because we understand that there's nothing better than knowing you've done a great job, and knowing that you're respected for it by the people whose opinion really matters - the people you work with.**



TOOLS

**TOOLBANK**



**IRWIN TOOLS manufactures and distributes professional grade hand tools and power tool accessories worldwide for trade professionals who demand superior performance and durability on the job.**

**IRWIN TOOLS' brand portfolio features user-preferred category leaders such as IRWIN®, Vise-Grip®, Quick-Grip®, Strait-Line®, Jack Saws®, Gilbow®, Marples®, Record®, Jordan® Lenox®**



**TOOLBANK**



**Lighthouse® are a leading supplier of torches and batteries. The range is comprehensive and vast with high performance LED technology. There are a range of counter display cut-cases available for greater sale opportunities.**



TOOLS

**TOOLBANK**



**The SCAN range of safety products is designed to protect wearers in the most frequently occurring circumstances under which personal protection is either required or recommended in building, construction, maintenance and associated industries.**



**TOOLBANK**



**We firmly believe that our tools make life simpler, safer and 'full of joy' for our users.**

**We shall never be content with existing standards. But unlike others, we do not believe that tools have reached their ultimate stage of development. We are always searching for new ideas. We think differently. We question things.**

**And in so doing, develop screwdriving tools such as the Zyklop ratchet and the Joker open-end wrench - tools that have turned the familiar into the ordinary.**



TOOLS

**TOOLBANK**





**For pricing, please contact your local IADA dealer**

### 32pc 1/2" Sq Drive Socket Set Metric/Imperial



**DUAL FINISH**

MM & IMP

**Gear 2 Gear**

**LIFETIME GUARANTEE**

**Premier**

- Flip reverse gear-to-gear ratchet with quick release.
- 24 x 6-point WallDrive® sockets cover sizes from 8-32mm and 3/8"-11/16".
- **Model No. AK693**

### 21pc Jumbo Combination Spanner Set



**Premier**

Jumbo Sizes

6-32mm

**LIFETIME GUARANTEE**

- Drop-forged Chrome Vanadium steel spanners.
- Hardened, tempered and chromed with fully polished, mirror finish.
- Open-end and WallDrive® ring combination with long slim shaft.
- Sizes: 6-19, 21-24, 27, 30, 32mm.
- Supplied in storage/hanging pouch.
- **Model No. AK6083**

### 25pc Combination Spanner Set



6-32mm

**Premier**

**LIFETIME GUARANTEE**

- Slim style Chrome Vanadium steel spanners with a satin polished finish for corrosion resistance.
- Open-end and 12-point WallDrive® ring combination.
- Sizes: 6-28, 30, 32mm.
- Supplied in storage/hanging pouch.
- **Model No. AK63253**

### 32pc 1/2" Sq Drive Socket Set Metric/Imperial



**DUAL FINISH**

MM & IMP

**Gear 2 Gear**

**LIFETIME GUARANTEE**

**Premier**

- Flip reverse gear-to-gear ratchet with quick release.
- 24 x 6-point WallDrive® sockets cover sizes from 8-32mm and 3/8"-11/16".
- **Model No. AK693**

### 9pc Long Ball-End Hex Key Set

Long

1.5-10mm

**LIFETIME GUARANTEE**

- Keys range in length from 79mm to 180mm and in size from 1.5mm to 10mm.
- Ball-end allows key to drive fixing at up to 30° from the fixing's axis.
- Contents: 1.5, 2, 2.5, 3, 4, 5, 6, 8, 10mm.
- **Model No. AK7139**

### 12pc Blind Bearing Puller Set



- Medium stroke 1.5kg slide hammer with 395mm shaft and a screw-type bridge extractor.
- Gently removes blind bearings.
- Bearing extractor collets with internal capacity from 8-34mm.
- **Model No. AK716**

### 0-150mm(0-6") Digital Vernier Caliper

MM & IMP



- 11mm LCD display.
- Hardened and tempered stainless steel with satin finish.
- Metric and Imperial readings with conversion between the two.
- Zero setting control for comparative measurement.
- **Model No. AK962EV**

### 19pc HSS Cobalt Fully Ground Drill Bit Set



HSS COBALT

1-10mm

- Fully ground HSS with 5% Cobalt makes these ideal for drilling extra hard materials.
- 135° Split point bit enables bits to bite workpiece quickly, reducing the need for centre mark.
- Sizes: Ø1-10mm in 0.5mm increments.
- **Model No. AK4701**

### 7 Drawer Rollcab with Ball Bearing Slides



**HEAVY DUTY**

7 Drawer

**Superline PRO**



- All heavy gauged steel construction and manufactured with steel inner walls for extra strength and durability.
- Heavy-duty 45mm ball bearing drawer slides provide superior performance and carry heavier loads.
- Also includes a 10mm thick top mat.
- Overall Size (W x D x H): 685 x 465 x 1005mm.
- **Model No. AP33479**

### Ø200mm Variable Speed Bench Grinder

Ø200mm Stone

Induction Motor



- Supplied with stone guards attached, adjustable eye shields and spark arrestors.
- Substantial tool rests, one with angled cut-out assisting effective tool sharpening.
- Variable speed allows for better control of grinding and sharpening.
- **Model No. BG200WVS**

### 25pc Hydraulic Puller Set

10tonne

**Hydraulic**



- Master set of gear pullers and bearing separators.
- Forged steel bearing separator.
- 10tonne Ram with enough force to remove most stubborn bearings, pulleys and shafts.
- See contents on website.
- **Model No. PS982**

### 300mm/12" Steel Rule

- High quality steel rule permanently marked in Metric and Imperial graduations.

• **Model No. AK9641**

**LIFETIME GUARANTEE**

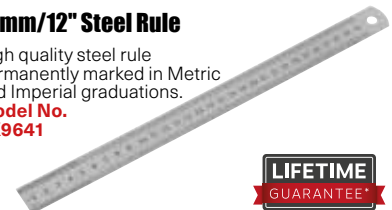

### Hydraulic Bearing Separator/Puller

- Forged steel 3-way bearing separator and gear puller set.
- Operated with supplied 10tonne hydraulic ram or manual force screw.
- Manual Thrust Screw Length: 210mm.
- Selection of extension rods (x3): 15, 65, 185, 340mm.
- Puller Leg Reach (Size/Spread): 160 (190)mm.
- Separator Capacity: 30-84mm.
- **Model No. PS9821**



**Hydraulic**

10tonne

### 10tonne Snap Hydraulic Body Repair Kit

**Hydraulic**

Snap

10tonne



- Heavy gauge snap-together pipework and cast snap-together attachments.
- Compatible with most other leading makes of snap-together equipment.
- Supplied with 10tonne hand operated pump, hose, hydraulic ram and storage case.
- **Model No. RE97/10**

### 20tonne Snap Body Repair Kit

20tonne

**Hydraulic**

Snap

- Heavy gauge snap-together pipework and snap-together attachments.
- Compatible with most other leading makes of snap-together equipment.
- Supplied with 20tonne hand operated pump, hose, hydraulic ram and metal storage case.
- **Model No. RE9720**



**For pricing,  
please  
contact  
your  
local  
IADA dealer**

## 24" 230V Industrial High Velocity Drum Fan - Premier



- High efficiency industrial fan with improved motor and blade design, resulting in higher velocity with up to 30% more area coverage and reach.
- Robust unit with heavy-duty gauge steel casing, guard and frame.
- Handle, wheels and tilt function cradle stand, allow the control of airflow where it is needed.
- Carefully balanced and fully guarded blades provide safe operation.
- Maximum Airflow: 266m<sup>3</sup>/min(9,420cfm).
- **Model No. HVD24P**



## Bottle Jacks



- 2tonne
- 3tonne
- 5tonne
- 8tonne
- 10tonne
- 12tonne
- 15tonne
- 20tonne
- 30tonne
- or
- 50tonne

- Fitted with overload valve.
- Base and reservoir machine welded.
- Supplied with 2pc handle.

Model No.	Capacity	Min./Max Height
<b>SJ2</b>	2tonne	168/316mm
<b>SJ3</b>	3tonne	188/363mm
<b>SJ5</b>	5tonne	207/402mm
<b>SJ8</b>	8tonne	222/447mm
<b>SJ10</b>	10tonne	222/447mm
<b>SJ12</b>	12tonne	227/457mm
<b>SJ15</b>	15tonne	227/457mm
<b>SJ20</b>	20tonne	235/445mm
<b>SJ30</b>	30tonne	260/420mm
<b>SJ50</b>	50tonne	280/450mm

## 7pc Combination Ratchet Spanner Set



- Chrome Vanadium steel ratchet combination spanner set.
- Sizes: 8, 10, 12, 13, 14, 17, 19mm.
- 72-Tooth ratchet ring and gear set requiring only 5° rotation to pick up the next tooth.
- Supplied in storage rack.
- **Model No. S01142**

## 21pc 1" Sq Drive Socket Set



- Heat treated, drop-forged, Chrome Vanadium steel with fully polished chrome plating for corrosion resistance.
- See contents on website.
- **Model No. S0768**

## 20tonne Floor Type Hydraulic Press



- Hydraulic**
- Floor Standing
- SLIDING RAM
- 20tonne
- 75+ KG HEAVY ITEM

- Table Aperture: 100mm.
- Working Table Width: 630mm.
- Ram Stroke: 185mm.
- Overall Height: 1796mm.
- Detachable pump and ram allowing hydraulics to be used for other purposes when press is not in use.
- Supplied with gauge.
- **Model No. YK20F**

## 10tonne Bench 'C' Type Hydraulic Press

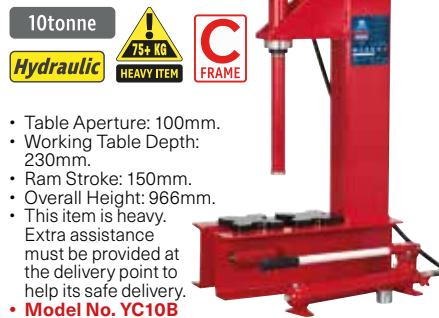

- 10tonne
- 75+ KG HEAVY ITEM
- C FRAME
- Hydraulic
- Table Aperture: 100mm.
- Working Table Depth: 230mm.
- Ram Stroke: 150mm.
- Overall Height: 966mm.
- This item is heavy. Extra assistance must be provided at the delivery point to help its safe delivery.
- **Model No. YC10B**

## 44pc Hammer-Thru Screwdriver, Hex Key & Bit Set



- Selection of popular sized hammer-thru screwdrivers, hex keys, bit driver and bits.
- Chrome Vanadium steel satin finish hexagonal shafts with shot blasted and magnetized tips.
- Contoured soft grip handles.
- **Model No. S01106**

## 36" 230V Industrial High Velocity Drum Fan - Premier



- High efficiency industrial fans with improved motor and blade design resulting in higher velocity with up to 30% more area coverage and reach.
- Robust unit with heavy-duty gauge steel casing, guard and frame.
- Handle, wheels and tilt function cradle stand, allow the control of airflow where it is needed.
- Carefully balanced and fully guarded blades provide safe operation.
- Suitable for industrial, commercial, agricultural, automotive and showroom applications.
- Maximum Airflow: 363m<sup>3</sup>/min(12,855cfm).
- Fitted with 3-pin plug.
- **Model No. HVD36P**



## Micrometer Torque Wrenches



- Flip reverse Chrome Vanadium steel ratchet heads with smooth action mechanism.
- Scale graduated in Nm and lb.ft.
- Calibration tolerance in accordance with BS EN ISO 6789-1:2017.
- Wrenches are individually tested to standards with ±4% accuracy and each wrench is issued with an individually numbered test certificate.
- Aluminium knurled handle for comfort and control.
- Supplied in EVA tray.



**LIFETIME GUARANTEE**



Model No.	Colour	Drive	Range
<b>STW901</b>	Green	1/4" Sq	5-25Nm (3.7-18.5lb.ft)
<b>STW902</b>	Blue	3/8" Sq	5-25Nm (3.7-18.5lb.ft)
<b>STW903</b>	Blue	3/8" Sq	20-120Nm (14.8-88.6lb.ft)
<b>STW904</b>	Red	1/2" Sq	40-220Nm (29.5-162.4lb.ft)
<b>STW905</b>	Red	1/2" Sq	60-330Nm (44.3-243.5lb.ft)

Specifications and descriptions on this promotion are given in good faith but may change without notice and do not form any part of a sale contract. E & OE.

\*Please refer to www.sealey.co.uk/guarantee for more information on guarantees. TRX-STAR, TRX-TS and TRX-P tools are suitable for driving TORX® and TORX PLUS® fasteners respectively. TORX® and TORX PLUS® are registered trademarks of Acument Intellectual Properties, LLC.

**TOOLS**

## Get the right tool for the job



Draper Tools established in 1919.  
Your trusted supplier of trade quality tools to IADA Members.



Tool Storage



Socket Sets



Spanners & Wrenches



Power Tools



Electrical Tools



Screwdrivers, Keys & Bits



Pliers



Hand & Engineering Tools



Punches, Hammers & Chisels



Cutting Tools & Saws



Vehicle Service Tools



Airtools



Lighting

Our hand tools come with a Lifetime Warranty, so both you and your customer can choose Draper with confidence.



**DRAPER TOOLS – BUY NOW AT YOUR LOCAL IADA SERVICE CENTRE**

**NEED TECHNICAL SUPPORT?**  
Get in touch with our Product Experts:  
+44 (0) 23 8049 4344



[drapertools.com](http://drapertools.com)





# New Comprehensive Tool Kit

Fully loaded with everything you need to get the job done!

## Mechanics Tool Kit (127 Piece)

- Comprehensive range of auto hand tools
- Manufactured from chrome vanadium steel
- Draper Expert HI-TORQ and MULTI-DRIVE sockets and spanners
- Reinforced lockable case with aluminium trim



List Price:  
**£210.00** ex. VAT  
 each

Stock No. **32027** Part No. **TK127**

+2 @ <b>£119.98</b> Each	+4 @ <b>£109.98</b> Each	+6 @ <b>£99.98</b> Each	Net Price	N/A	<b>BULK BUY</b>
--------------------------------	--------------------------------	-------------------------------	-----------	-----	-----------------

E. & O.E. All prices Exclude VAT and are only available while stocks last. Prices correct at the time of going to press and are valid until 30 June 2021. These prices may not apply to our website. Draper Tools Ltd reserves the right to change prices without prior notice. Excludes any other offers and discount arrangements. All photographs are as a guide only and do not necessarily represent the products on offer. Designed and published by Draper Tools Ltd.

[b2b.drapertools.com](http://b2b.drapertools.com)

[sales@drapertools.com](mailto:sales@drapertools.com)

+44 (0) 23 8049 4333

Draper Area Sales Manager

TOOLS



## MAKE THE PROFESSIONAL CHOICE

*Toolkits that create a safer and more efficient work environment for the user and the organisation alike.*



### SOCKETS & ACCESSORIES

Sockets made from extra strong chrome vanadium steel and a wide selection of ratchets & accessories



### SPANNERS

Manufactured to DIN and ISO standards for quality and size tolerances.



### SCREWDRIVERS

Blades have steel alloy wings that the plastic handle is moulded around maximising the torque that can be applied.



1000V

### INSULATED TOOLS

All VDE insulated tools are individually tested and manufactured to the highest standard, IEC 60 900 & DIN EN 60900.



### TORQUE WRENCHES

TengTools have become an industry standard, accurate to  $\pm 4\%$  and conform to ISO6789.



Get organised™



# WORKSHOP EQUIPMENT C55

The modular workshop that allows you to create a modern work environment customised to fit your space and storage needs.

Choose from a wide range of solutions sharing high quality standards, designed to make the most of your time by optimising your working environment.



Quick release system throughout the length of the drawer



Aluminium shutter with lock for protecting tools



Mobile roller tool cabinet with 2 fixed and 2 steering wheels making it easy to manoeuvre



Drawers can accommodate thermoformed tool trays

[www.beta-tools.co.uk](http://www.beta-tools.co.uk)

TOOLS



DELIVERING COST  
EFFECTIVE MATERIAL  
REMOVAL &  
CUTTING SOLUTIONS  
TO ALL MAJOR  
MANUFACTURING  
INDUSTRIES ACROSS  
THE UK.



CUTTING  
TOOLS &  
ABRASIVES



ATA Tools  
Air Tools



ATA Garryson  
Essential Abrasives

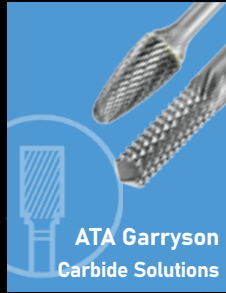

ATA Garryson  
Carbide Solutions



ATA Karnasch  
Cutting Tools

## TOP QUALITY - NO COMPROMISE

Our products meet the highest demands for precision and longevity with 100% quality control, providing industry solutions for **Grinding, Milling, Drilling, Threading, Sinking, Sawing** and **Hole Cutting**,

### LOCAL

Local sales support  
across the UK

### SUPPLY

Guaranteed UK distribution  
and supply chain

### RELIABLE

Successfully serving the UK  
market since the early 1970s

Visit us at [atagroup.com](http://atagroup.com) and [karnasch.co.uk](http://karnasch.co.uk)

Designing and manufacturing the most comprehensive and advanced range of tungsten carbide burs, pneumatic tools and abrasives to serve the most demanding of industries.



## Essential Abrasives

Here at ATA Garryson we offer a comprehensive range of high quality abrasives ranging from flap discs, cutting discs and mounted points, designed for light to heavy material removal, finishing and preparation.



### Zirconium Flap Discs

The most popular flap disc due to the self-sharpening action of the cloth. Available from 36 - 120 grit.



### Quickchange Discs

The easy locking system gives a quick disc changeover. For general purpose use on ferrous and non-ferrous materials.



### Flap Wheels

Typical applications include cleaning weld surfaces, removing die lines, paint or rust removal and sanding. A workshop essential.



### Spirabands

Ideal for removing surface defects, machining marks, heavy oxidation, weld splatter and cleaning on all metals.



### Shop Rolls

Tough, durable abrasive cloth for a variety of manual cleaning, blending, de-burring and polishing.



### Hand Pads

Non-woven hand pads for manual cleaning - wet or dry, and can be cut to size. Removes imperfections without affecting the workpiece.



ATA Garryson and Karnasch Professional Tools, stands for an innovative and diverse product range and professional customer-oriented service. **Made for professionals.**





atagroup.com

## Carbide Burs and Air Tools

ATA Garryson Carbide Burs are renowned for their consistent high quality and resistance to heat and wear, and our complementary range of quality made Air Tools includes a large range of grinders and sanders.



**Double Cut Bur Set  
GGBKIT28**

5 piece set of the most commonly used shapes, designed to give efficient stock removal.



**Bolt Remover Kit  
GGBKIT41**

5 piece set designed for the removal of broken studs. Perfect for automotive repair and maintenance.



**Alloy Specific Bur Range  
GGBKIT39**

40% more effective material removal, precise control and improved finish on high strength alloys.



**Locksmith Set  
GGBKIT43**

Tailor made range developed for the locksmith industry and automotive repair shops.



**ATA Die Grinder  
SMD30LR**

Compact and light weight low vibration die grinder. Ergonomically designed moulded sleeve for improved operator comfort.



**ATA Small Angle Sander  
RAM Range**

Designed for operator comfort and can be used with burs and quickchange discs,



## Karnasch Professional Tools

Using the highest grade materials and coating technology available, KARNASCH high-performance tools are synonymous with quality in professional machining and manufacturing applications.

- Extensive range of high-end precision and industrial cutting tools, all available for immediate delivery.
- Machined using the highest grade tool materials, ensuring product safety, performance and extended tool life.

### PRECISION CUTTING TOOLS Milling - Drilling - Sinking - Grinding



One of the world's largest ranges of tools and sets for milling, drilling and countersinking available to order today. With superior quality end mills, spade drills, step drills, countersinks and a comprehensive stock of carbide burs available with tool coating variants BLUE-TEC and BLACK-TEC for optimal machining results.



### HOLE SAWS Diameters from 6mm to 305mm



Karnasch has over 1,100 hole saws in the range suitable for hand drills, pillar drilling, radial drilling, lathe or hole cutting machines.

### ANNULAR CUTTERS 8mm to 200mm diameters



The annular cutters, rail cutters and twist drills by Karnasch guarantee fast and precise drilling of the highest quality at competitive prices.

### MAGNETIC DRILLS Up to 110mm drilling depth



These machines are fitted with a premium quality German motor and a range of added features.

### CIRCULAR SAWS 15mm to 2250mm diameters



With the largest range worldwide, Karnasch Professional Tools has over 3,000 different circular saws.

Visit us at [atagroup.com](http://atagroup.com) and [karnasch.co.uk](http://karnasch.co.uk)

# DORMER PRAMET

## A LEADING GLOBAL SUPPLIER OF METAL CUTTING PRODUCTS AND SERVICES

Dormer Pramet is a leading manufacturer and supplier of metal cutting tools. Our global footprint includes more than 20 sales offices, production facilities on three continents and a highly-developed logistics network. With one of the industry's most complete and versatile product programs, we offer an unrivalled range of high quality, fit-for-purpose rotary and indexable tools from one single source.

## DRILLING

### HSS TiN Straight Shank Jobber Drill (A002)

- HSS TiN Coated Jobber Drill for general machining applications up to x4 diameter
- Titanium Nitride tip coating (2.0mm and above) not only minimises wear and increases tool life, but also allows increased performance
- Features self-centring split-point for excellent positional accuracy and hole quality
- Excellent performance in a wide range of materials
- Improved flute geometry for rapid chip evacuation
- Manufactured to BS328/DIN338 standards
- Available in sizes up to 16.0mm



### Benefits

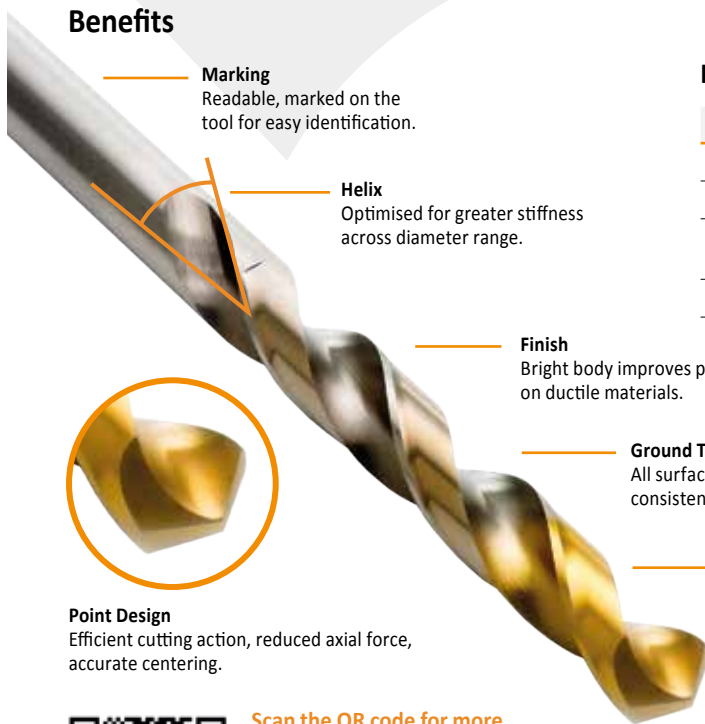

**Marking**  
Readable, marked on the tool for easy identification.

**Helix**  
Optimised for greater stiffness across diameter range.

**Finish**  
Bright body improves performance on ductile materials.

**Ground Tool**  
All surfaces ground for consistent precision.

**Coating**  
Titanium nitride resists flank and crater wear and has low friction, promoting increased cutting speeds.

**Point Design**  
Efficient cutting action, reduced axial force, accurate centering.



Scan the QR code for more information on Dormer's A002 HSS Drill.

**Web Design**  
Optimised strength and rigidity, easy to feed.

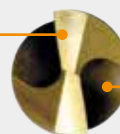

**Flutes**  
Improved flute geometry for efficient chip form and evacuation.

### HSS TiN Straight Shank Jobber Drill Set (A095)

Code	Pieces	Size Range
A095201	19 Piece	1.0mm - 10.0mm x 0.5mm
A095204	25 Piece	1.0mm - 13.0mm x 0.5mm
A095206	29 Piece	1.0mm-13.0mm x 0.5mm +3.3mm, 4.2mm, 6.8mm, 10.2mm
A09518	29 Piece	1/16 inch -1/2 inch x 1/64 inch

CUTTING TOOLS & ABRASIVES





### HSS Straight Shank Jobber Drill (A100)

- HSS Jobber Drill for general machining applications up to x4 diameter
- Silver ring for easy tool identification and your guarantee of Dormer quality
- 118° point angle
- Steam tempered finish for improved wear resistance
- Manufactured to BS328/DIN338 standards
- Available in sizes up to 20.0mm



### HSCo Straight Shank Heavy Duty Jobber Drill (A777)

- HSCo Heavy Duty Straight Shank Jobber Drills for machining higher tensile & tougher materials up to x4 diameter
- 135° split point geometry aids durability and improves hole size, finish and quality
- Bronze finish for easy tool identification
- Manufactured to DIN338 standards
- Available in sizes up to 16.0mm

### 5PC A002 TiN Coated Jobber Drill Set (A08910)

- Contains: A002 HSS TiN Coated Jobber Drills: 4.0, 5.0, 6.0, 8.0 & 10.0mm



### HSS Straight Shank Stub Drill (A120)

- HSS Stub Drill for general machining applications up to x2.5 diameter
- Ideal for use in portable drills, turrets and automatic lathes
- Features self-centring split-point for excellent positional accuracy and hole quality
- Manufactured to DIN1897 standards

## SUPERCUT

### Supercut High Performance, Original, Aerosol and Compound

Supercut, Dormer Pramet's cutting tool lubricant range which is suitable for all of your metal cutting applications. The lubricant is available in standard and chlorine free formulas and comes in fluid (bottle) aerosol (can) or compound (tin) form.

- Excellent cutting performance
- High viscosity formula, excellent adhesion to the tool
- Low odour solvent free formula
- Can be used on all metals
- Increased tool life, better surface finishes and closer tolerances
- Supercut High performance is chlorine free and compatible with water based process fluids
- Supercut Aerosol and Compound have a Chlorine, Sulphur and Phosphorous free formula



### HSS Straight Shank Long Series Drill (A110)

- HSS Long Series Drill for general machining applications up to x6 diameter
- Ideal for deeper hole drilling or where a slightly longer reach is required
- Steam tempered finish for improved wear resistance
- Manufactured to DIN340 standards



Supercut	Code
Original	2F7830400G
High Performance	2F7830340CF
Compound	2F7830450G
Aerosol	2F7830300ML

# DORMER PRAMET

## COUNTERSINKS

### HSS Countersink with Tri-Flat - 90°

- Designed to chamfer holes to accommodate standard fasteners with 90° heads
- 3 Flute, bright finish, ground all over
- Can also be used as a de-burring tool



Code
<b>Countersinks</b>
G1066.3
G1068.3
G10610.4
G10612.4
G10616.5
G10620.5
G10625.0
<b>Set</b>
G2364



### 6pc Countersink Set (G236)

- Contains 6 x G136 HSS 90° Countersinks
- Countersinks included = 6.3mm, 8.3mm, 10.4mm, 12.4mm, 16.5mm, 20.5mm

## BURRS

### Double Cut

- First choice for general machining
- Improves ease of control
- Increases metal removal rate
- Breaks swarf into small manageable pieces
- TiN coated burrs available as standard, aluminium geometry burrs available as standard

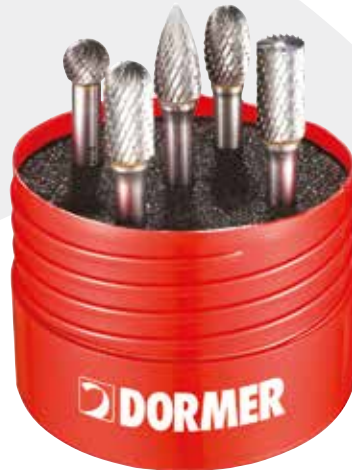

### 5 PC Solid Carbide Rotary Burr Set (P88001)

Contains 5 x Solid Carbide Burrs (9.6 x 6.0mm)  
 Styles Contained: Cylinder with End Cut (P803), Ball Nosed Cylinder (P805), Ball (P807), Oval (P809) & Pointed Tree (P813)

## BOLT REMOVAL KITS

Unique sets for the easy removal of broken bolts

**NEW**

Ordering Code	Description	Consists of
S-P102M6-M8	Bolt Removal Kit M6-M8	A1173.0, P1004.9, P1014.9, X106XM100NO2
S-P102M8-M10	Bolt Removal Kit M8-M10	A1174.0, P1006.4, P1016.4, X106XM100NO3
S-P102M10-M12	Bolt Removal Kit M10-M11	A1174.2, P1007.8, P1017.8, X106XM100NO3
S-P102M12-M14	Bolt Removal Kit M12-M14	A1176.0, P1009.3, P1019.3, X106XM100NO4
S-P102M14-M16	Bolt Removal Kit M14-M16	A1178.0, P10010.7, P10110.7, X106XM100NO5

This set contains:

- 1 Bolt Milling Burr (P100)
- 1 Bolt Centering Burr (P101)
- 1 Stub Drill HSS-Co (A117)
- 1 Screw Extractor (X106X)

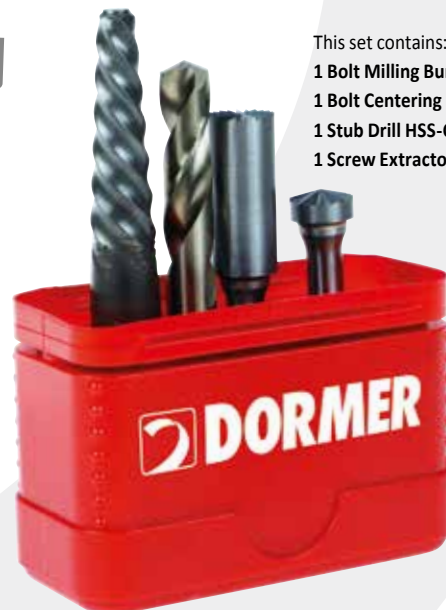

Scan the QR code to watch how to safely remove a broken bolt.



## TAPPING

### High Quality HSS Hand Taps

- Versatile general purpose taps for threading blind or through holes in most materials
- Suitable for hand or machine use
- Manufactured to ISO529 standards

	E500 (M)	E513 (MF)	E515 (UNC)	E524 (UNF)	E547 (BSP G)
<b>Sizes available:</b>	M1-M56	M3-M50	1-64-2	0-80-1.1/2	1/8-2

All Dormer Hand Taps are available in either Taper, Second or Plug variants:

#### Ordering Hand Taps

NO1 = Taper



NO2 = Second



NO3 = Plug



NO6 = Set of 3 (NO1, NO2, NO3)

Available as a 3PC set, E500M3NO6



### 14PC HSS TiN Coated Jobber Drill & HSS Straight Flute Hand Tap Set (L115101)

- Contains 7 x E500 HSS ISO Hand Taps & equivalent A002 HSS TiN Coated Jobber Drills
- Taps included = M3, M4, M5, M6, M8, M10, M12
- Contains x7 E500-NO3 plug variant straight flute hand taps
- Drills included = 2.5, 3.3, 4.2, 5.0, 6.8, 8.5, 10.2

CUTTING  
TOOLS &  
ABRASIVES



## 8913 siacut Cutting Disks



### The professional abrasive for higher cutting power

The hard cutting discs of the 8913 siacut Series never fail to impress, with a high cutting power, low level of heat discolouration and reduced burring.

#### Features:

High cutting speed. Comfortable to use with little contact pressure. Long product life

#### Applications:

Cutting of pipes and profiles. Cutting of solid materials and bars. Cutting of sheets

Mfct part number	Size (mm)
0020.8716	76x1.0x10.00
0020.8718	100x1.0x16.00
0020.8720	115x1.0x22.23
0020.8721.01	115x1.6x22.23
0020.8722.01	115x2.5x22.23
0020.8724	125x1.0x22.23
0020.8725.01	125x1.6x22.23
0020.8726.01	125x2.5x22.23
0020.8730	230x1.8x22.33
0020.8731	230x2.0x22.33
0020.8732.01	230x2.5x22.33
0020.8733.01	230x3.0x22.33

## 8933 siagrind Grinding Disks



The hard grinding discs of the special 8933 siagrind series excel in a variety of metal applications and make for robust and efficient tools thanks to features such as high removal rates at low surface pressure and long life.

#### Features:

High performance for stock removal. Comfortable to use with little contact pressure. Long lifetime

#### Applications:

Welded seam preparation. Removing solid material

Mfct part number	Size (mm)
0020.8736	230x6.0x22.23
0020.8738.01	115x6.0x22.23
0020.8739.01	125x6.0x22.23
0020.8740.01	180x6.0x22.23
0020.8741.01	230x6.0x22.23

## 2824 siaflap Flap Discs



A universal abrasive product designed for the surface treatment of unalloyed or low-alloyed steels, the 2824 siaflap flap disc with zirconia corundum and robust cloth backing provides high stock removal rates and long life.

#### Applications:

Surface finishing, weld removal and preparation, deburring, smoothing and blending flaws

#### Features:

High performance due to zirconia alumina abrasive grit. Consistent surface quality until the abrasive is completely worn, lower vibration than grinding discs. For market-leading performance in steel applications.

Mfct part number	Size (mm)	Grit
0020.2651	115 x 22mm	40
0020.2653	115 x 22mm	60
0020.2655	115 x 22mm	80
0020.2677	115 x 22mm	120

0020.2657	125 x 22mm	40
0020.2659	125 x 22mm	60
0020.2661	125 x 22mm	80

## 4819 Zirconia Fibre Discs



### The specialist abrasive for unalloyed steels and non-ferrous metals

Specially designed for applications involving steel and non-ferrous metals, 4819 siaron 8 fibre discs achieve, among other things, high stock removal rates and have a long life.

#### Applications:

Weld preparation. Sanding down. Surface finishing. Deburring, smoothing and blending of flaws. Removing discolouration. Removal of rust

Mfct part number	Size (mm)	Grit
0785.2867.0024	100 x 16mm	24
0785.2867.0036	100 x 16mm	36
0785.2867.0040	100 x 16mm	40
0785.2867.0050	100 x 16mm	50
0785.2867.0060	100 x 16mm	60
0785.2867.0080	100 x 16mm	80
0785.2867.0100	100 x 16mm	100
0785.2867.0120	100 x 16mm	120

7120.5813.0024	115 x 22mm	24
7120.5813.0036	115 x 22mm	36
7120.5813.0040	115 x 22mm	40
7120.5813.0050	115 x 22mm	50
7120.5813.0060	115 x 22mm	60

7120.5813.0080	115 x 22mm	80
7120.5813.0100	115 x 22mm	100
7120.5813.0120	115 x 22mm	120

7340.2591.0024	125 x 22mm	24
7340.2591.0036	125 x 22mm	36
7340.2591.0040	125 x 22mm	40
7340.2591.0050	125 x 22mm	50
7340.2591.0060	125 x 22mm	60
7340.2591.0080	125 x 22mm	80
7340.2591.0100	125 x 22mm	100
7340.2591.0120	125 x 22mm	120

6810.2419.0024	180 x 22mm	24
6810.2419.0036	180 x 22mm	36
6810.2419.0040	180 x 22mm	40
6810.2419.0050	180 x 22mm	50
6810.2419.0060	180 x 22mm	60
6810.2419.0080	180 x 22mm	80
6810.2419.0100	180 x 22mm	100
6810.2419.0120	180 x 22mm	120

## 4570 siabite X Ceramic Fibre Discs



### The fibre disc for the coolest grinding with new and unique X-Technology

Thanks to innovative X-Technology, the 4570 siabite fibre disc brings you considerably cooler grinding with a long service life and a consistent cutting performance on stainless steel and mild steel. With new and unique X-Technology, an active cooling aid is applied directly to the top level, which enhances cooling and minimises discolouration

#### Applications:

Weld removal. Removal of scale and mill scale. Blending flaws. Removing discolouration

Mfct part number	Size (mm)	Grit
5369.8301.0036	100 x 16mm	36
5369.8301.0060	100 x 16mm	60
5369.8301.0080	100 x 16mm	80
5369.8301.0120	100 x 16mm	120

1737.3366.0036	115 x 22mm	36
1737.3366.0060	115 x 22mm	60
1737.3366.0080	115 x 22mm	80
1737.3366.0120	115 x 22mm	120

1935.3923.0036	125 x 22mm	36
1935.3923.0060	125 x 22mm	60
1935.3923.0080	125 x 22mm	80
1935.3923.0120	125 x 22mm	120

1426.9972.0036	100 x 16mm	36
1426.9972.0060	100 x 16mm	60
1426.9972.0080	100 x 16mm	80
1426.9972.0120	100 x 16mm	120





## 4581 siaramic X Lock Ceramic Fibre Discs



### The ceramic fibre disc for maximum performance on steel

The coarser grits of the 4581 siaramic series are developed for an extraordinarily high stock removal speed on unalloyed/low-alloyed steels. The long lifetime of the disc is an additional benefit of the shaped siaramic grain. Additionally, the ceramic fibre disc distinguishes through a consistent cut in finer grits on unalloyed/low-alloyed steels what results in a superb surface quality.

#### Applications:

Weld removal. Blending flaws. Removing discolouration. Removal of scale and mill scale

Mfct part number	Size (mm)	Grit
5598.5922.0036.01	100 x 16m	36+
5598.5922.0060.01	100 x 16m	60+
5598.5922.0080.01	100 x 16m	80+

6923.1272.0036.01	115 x 22mm	36+
6923.1272.0060.01	115 x 22mm	60+
6923.1272.0080.01	115 x 22mm	80+

7142.8050.0036.01	125 x 22mm	36+
7142.8050.0060.01	125 x 22mm	60+
7142.8050.0080.01	125 x 22mm	80+

1655.7593.0036.01	180 x 22mm	36+
1655.7593.0060.01	180 x 22mm	60+
1655.7593.0080.01	180 x 22mm	80+

## 4582 siaramic X Lock Ceramic Fibre Discs



### The ceramic fibre disc for maximum performance on stainless steel

The coarser grits of the 4582 siaramic series are developed for an extraordinarily high stock removal speed on stainless steel (thanks to the cooling aid) as well as unalloyed/low-alloyed steels. The long lifetime of the disc is an additional benefit of the shaped siaramic grain.

#### Features:

Cool cut. Long lifetime. Uniform cutting performance. Fine surface finish. X-LOCK compatible

#### Applications:

Weld removal. Blending flaws. Removing discolouration. Removal of scale and mill scale

Mfct part number	Size (mm)	Grit
5611.5474.0036.01	100 x 16m	36+
5611.5474.0060.01	100 x 16m	60+
5611.5474.0080.01	100 x 16m	80+
5611.5474.0120.01	100 x 16m	120+

6936.0824.0036.01	115 x 22mm	36+
6936.0824.0060.01	115 x 22mm	60+
6936.0824.0080.01	115 x 22mm	80+
6936.0824.0120.01	115 x 22mm	120+

7155.7602.0036.01	125 x 22mm	36+
7155.7602.0060.01	125 x 22mm	60+
7155.7602.0080.01	125 x 22mm	80+
7155.7602.0120.01	125 x 22mm	120+

1690.3366.0036.01	180 x 22mm	36+
1690.3366.0060.01	180 x 22mm	60+
1690.3366.0080.01	180 x 22mm	80+
1690.3366.0120.01	180 x 22mm	120+

## 2829 Zirconia Cloth File Belts



### The special belt sanding series for coarse dry sanding

The special 2829 zirconia series is ideal for unalloyed steels and non-ferrous metals in stationary belt sanding applications and in applications involving the use of powerfile sanders. It ensures an excellent finish without sacrificing such advantages as high stock removal rates, high edge stability or tear resistance.

#### Backing with very high stability and rigidity

Active additives with a cooling effect greatly reduce discolouration. Suitable for general use in dry and wet sanding applications

#### Applications:

Weld preparation. Removing discolouration. Sanding down. Surface finishing. Deburring. Smoothing and blending of flaws

Mfct part number	Size (mm)	Grit
7213.5249.0036	10 x 330mm	36
7213.5249.0040	10 x 330mm	40
7213.5249.0060	10 x 330mm	60
7213.5249.0080	10 x 330mm	80
7213.5249.0100	10 x 330mm	100
7213.5249.0120	10 x 330mm	120

0545.3697.0036	12 x 305mm	36
0545.3697.0040	12 x 305mm	40
0545.3697.0060	12 x 305mm	60
0545.3697.0080	12 x 305mm	80
0545.3697.0100	12 x 305mm	100
0545.3697.0120	12 x 305mm	120

3828.2548.0036	12 x 457mm	36
3828.2548.0040	12 x 457mm	40
3828.2548.0060	12 x 457mm	60
3828.2548.0080	12 x 457mm	80
3828.2548.0100	12 x 457mm	100
3828.2548.0120	12 x 457mm	120

7137.3854.0036	12 x 610mm	36
7137.3854.0040	12 x 610mm	40
7137.3854.0060	12 x 610mm	60
7137.3854.0080	12 x 610mm	80
7137.3854.0120	12 x 610mm	100
7137.3854.0120	12 x 610mm	120

## 2820 siamet Zirconia Spirabands



SIA 2820 Zirconia Spirabands are perfect for deburring and dressing of mild steel tubing and hard to reach areas. Featuring an X-wt Cloth/ Cotton backing and using active additives to help with grinding properties, the SIA 2820 Spiraband is a dynamic and adaptable abrasive

#### Features:

The abrasive used is Zirconia giving long life on steels and stainless steels

#### Applications:

Blending and shaping holes and grooves cut into materials to the correct shape & general deburring

Mfct part number	Size (mm)	Grit
6165.9712.0050	Ø 10/20mm (dia/width)	50
6165.9712.0060	Ø 10/20mm (dia/width)	60
6165.9712.0080	Ø 10/20mm (dia/width)	80

5476.2604.0050	Ø 15/30mm (dia/width)	50
5476.2604.0060	Ø 15/30mm (dia/width)	60
5549.6099.0080	Ø 15/30mm (dia/width)	80

1111.8190.0036	Ø 25/25mm (dia/width)	36
1111.8190.0050	Ø 25/25mm (dia/width)	50
1111.8190.0060	Ø 25/25mm (dia/width)	60
1111.8190.0080	Ø 25/25mm (dia/width)	80

5784.2604.0036	Ø 30/30mm (dia/width)	36
5784.2604.0050	Ø 30/30mm (dia/width)	50
5784.2604.0060	Ø 30/30mm (dia/width)	60
5784.2604.0080	Ø 30/30mm (dia/width)	80

6113.6717.0036	Ø 45/30mm (dia/width)	36
6208.6433.0050	Ø 45/30mm (dia/width)	50
6113.6717.0060	Ø 45/30mm (dia/width)	60
6208.6433.0080	Ø 45/30mm (dia/width)	80

1665.6836.0036	Ø 51/25mm (dia/width)	36
1665.6836.0050	Ø 51/25mm (dia/width)	50
1665.6836.0060	Ø 51/25mm (dia/width)	60
1665.6836.0080	Ø 51/25mm (dia/width)	80





## 2923 Cloth Spindle Mounted Flap Wheels



The dependable series for grinding of unalloyed and non-ferrous steel

As a cost-effective abrasive with a stable cloth backing, 2923 sialoX offers aggressive finish, good tear resistance and particularly long service life in a variety of applications including final grinding of unalloyed steel and non-ferrous metals



### Applications:

Wide range of applications. Highly flexible, ideal for hard to reach areas. Excellent price/performance ratio. Versatile all-round product with an attractive range of options. Universal product for all metals

Mfct part number	Size (mm)	Grit
0020.8274.01	Ø 20/10mm (dia/width)	40
0020.8275.01	Ø 20/10mm (dia/width)	60
0020.8276.01	Ø 20/10mm (dia/width)	80
0020.8277.01	Ø 20/10mm (dia/width)	120
0020.8278.01	Ø 20/10mm (dia/width)	150

0020.8299.01	Ø 30/15mm (dia/width)	40
0020.8300.01	Ø 30/15mm (dia/width)	60
0020.8301.01	Ø 30/15mm (dia/width)	80
0020.8302.01	Ø 30/15mm (dia/width)	120
0020.8303.01	Ø 30/15mm (dia/width)	150

0020.8309.01	Ø 40/20mm (dia/width)	40
0020.8310.01	Ø 40/20mm (dia/width)	60
0020.8311.01	Ø 40/20mm (dia/width)	80
0020.8312.01	Ø 40/20mm (dia/width)	120
0020.8313.01	Ø 40/20mm (dia/width)	150

0020.8324.01	Ø 50/25mm (dia/width)	40
0020.8325.01	Ø 50/25mm (dia/width)	60
0020.8326.01	Ø 50/25mm (dia/width)	80
0020.8327.01	Ø 50/25mm (dia/width)	120
0020.8328.01	Ø 50/25mm (dia/width)	150

0020.8334.01	Ø 60/15mm (dia/width)	40
0020.8335.01	Ø 60/15mm (dia/width)	60
0020.8336.01	Ø 60/15mm (dia/width)	80
0020.8337.01	Ø 60/15mm (dia/width)	120
0020.8338.01	Ø 60/15mm (dia/width)	150

0020.8344.01	Ø 60/30mm (dia/width)	40
0020.8345.01	Ø 60/30mm (dia/width)	60
0020.8346.01	Ø 60/30mm (dia/width)	80
0020.8347.01	Ø 60/30mm (dia/width)	120
0020.8348.01	Ø 60/30mm (dia/width)	150

## 1713 siawat Wet & Dry Sheet



For the highest-performance wet sanding materials

The 1713 siawat silicon carbide series makes all the difference when it comes to sanding coatings, impurities or

unevenness in edge zones and when fine sanding primer fillers, glass, composite

### Features:

High performance for stock removal with good finish. Long lifetime. Powerful silicon carbide grit for use on hard materials. Highly adaptable to contours and shapes. Can be used wet or dry

### Applications:

Sanding off coatings and impurities. Sanding out unevenness at the edges of repaired surfaces. Flattening bodyfiller and primer filler. Fine sanding primer filler, glass, composite. Keying old and new lacquers. Removing paint runs

Mfct part number	Size (mm)	Grit
8729.6054.0080	230 x 280mm	80
8729.6054.0100	230 x 280mm	100
8729.6054.0120	230 x 280mm	120
8729.6054.0150	230 x 280mm	150
8729.6054.0180	230 x 280mm	180
8729.6054.0220	230 x 280mm	220
8729.6054.0240	230 x 280mm	240
8729.6054.0280	230 x 280mm	280
8729.6054.0320	230 x 280mm	320
8729.6054.0360	230 x 280mm	360
8729.6054.0400	230 x 280mm	400
8729.6054.0500	230 x 280mm	500
8729.6054.0600	230 x 280mm	600
8729.6054.0800	230 x 280mm	800
8729.6054.1000	230 x 280mm	1000
8729.6054.1200	230 x 280mm	1200
8729.6054.1500	230 x 280mm	1500
8729.6054.2000	230 x 280mm	2000
8729.6054.2500	230 x 280mm	2500

## 1950 siaspeed S Performance Discs Paper



### For a perfect finish at full speed

The versatile all-round product 1950 siaspeed is specially designed for high stock removal rates, perfect surface quality and long life in applications such as the surface treatment of body filler, primer filler, lacquers and paints, composites

### Features:

Increased occupational health and safety due to dust free sanding. Higher productivity and process improvement. Improved cut, stock removal and overall life & performance

### Advantages:

Very high abrasive performance with a good finish. Performance-enhancing grit mix with ceramic corundum in 40 - 80 grit range. Minimal clogging thanks to open coating in 220 - 600 grit range. Extremely long lifetime leads to lower abrasive consumption. Versatile all-round product with an attractive range of options

Mfct part number	Size (mm)	Grit
1546.3150.0040	150mm	40
1546.3150.0060	150mm	60
1546.3150.0080	150mm	80
8443.7842.0100	150mm	100
8443.7842.0120	150mm	120
8443.7842.0150	150mm	150
8443.7842.0180	150mm	180
8443.7842.0220	150mm	220
8443.7842.0240	150mm	240
8443.7842.0280	150mm	280
8443.7842.0320	150mm	320
8443.7842.0400	150mm	400
8443.7842.0500	150mm	500
8443.7842.0600	150mm	600

## 1944 siaone Discs Paper 15 hole



The quality with aggressive cut and optimum lifetime. For price-conscious users for working with various materials, for example: bodyfiller, primer filler, varnish, paint and wood. Velcro type backing and an aluminium oxide open coating. Dry sanding, suitable for a broad range of application, stearate coating reduces clogging.

### Advantages:

Aggressive initial sanding thanks to optimised sanding grain. Process stability thanks to uniform scratch depths in all grits. Excellent price/performance ratio

Mfct part number	Size (mm)	Grit
7425.4595.0040	150mm	40
7425.4595.0060	150mm	60
7425.4595.0080	150mm	80
7425.4595.0120	150mm	120
7425.4595.0150	150mm	150
7425.4595.0180	150mm	180
7425.4595.0240	150mm	240
7425.4595.0320	150mm	320
7425.4595.0400	150mm	400
7425.4595.0500	150mm	500

## 7900 sianet discs



### The powerful net-backed abrasive

The special net structure of 7900 sianet enables dust-free sanding with the highest abrasive performance on all types of materials

### Advantages:

Full-surface dust extraction. High removal rate without clogging. Very efficient and productive. High tear resistance, thanks to sturdy net backing

Mfct part number	Size (mm)	Grit
6397.0967.0080	150mm	80
6397.0967.0100	150mm	100
6397.0967.0120	150mm	120
6397.0967.0180	150mm	180
6397.0967.0240	150mm	240
6397.0967.0320	150mm	320
6397.0967.0400	150mm	400



## 1815 siatop Zirconia discs



### For fast and cost-effective surface treatment of steel and non-ferrous metals

1815 siatop impresses with its high removal rate, long lifetime and very good finish in a wide range of disc and belt applications

#### Applications:

Removal of paint or rust. Weld preparation. Removing discolouration. Sanding down. Deburring

#### Advantages:

Versatile all-round product with an attractive range of options. Outstanding performance in dry sanding applications. Cost reduction thanks to long lifetime

Mfct part number	Size (mm)	Grit
4418.9881.0024	150mm	24
4418.9881.0036	150mm	36
4418.9881.0040	150mm	40
4418.9881.0050	150mm	50
4418.9881.0060	150mm	60
4418.9881.0080	150mm	80
4418.9881.0100	150mm	100
4418.9881.0120	150mm	120
4418.9881.0150	150mm	150

## 2820 siafix Quick Change Zirconium Discs



As a specialist product designed for dry sanding with high removal rates as well as excellent edge stability and tear resistance, 2820 siamet is suitable for a wide variety of jobs ranging from removal of rust or paint to welding preparation – whether on unalloyed steels or non-ferrous metals.

#### Application

Dressing of mild steel weld seams and joints in hard to reach areas or small parts

#### Advantages

Fast safe and easy discs change offered by the siafix quick change system

Mfct part number	Size (mm)	Grit
4917.8786.0040	50mm	40
4917.8786.0050	50mm	50
4917.8786.0060	50mm	60
4917.8786.0080	50mm	80
4917.8786.0120	50mm	120
4917.8786.0240	50mm	240
4917.8786.0320	50mm	320

5445.4510.0036	76mm	36
5445.4510.0040	76mm	40
5445.4510.0060	76mm	60
5445.4510.0080	76mm	80
5445.4510.0120	76mm	120
5445.4510.0180	76mm	180
5445.4510.0320	76mm	320

## 2511 siafix Quick Change Ceramic Discs



2511 siabite quick change discs are designed for mini grinders and provide maximum efficiency on high-alloy steel and other hard to grind metals thanks to the self-sharpening effect of the ceramic grit.

#### Applications:

Weld preparation. Sanding down small parts. Deburring. Smoothing and blending of flaws. Removing discolouration. Surface finishing

#### Advantages:

Less machine interruptions thanks to long lifetime. Minimal effort required thanks to highly aggressive abrasive grit. Reduced heat cutting thanks to active additive with cooling effect. More efficiency thanks to the highest performance

Mfct part number	Size (mm)	Grit
8185.7250.0040	50mm	40
0002.1244 / 8185.7250.0050	50mm	50
0002.1245 / 8185.7250.0060	50mm	60
0002.1246 / 8185.7250.0060	50mm	80
8185.7250.0120	50mm	120

0002.1247 / 8734.9195.0036	76mm	36
0002.1248 / 8734.9195.0040	76mm	40
0002.1248 / 8734.9195.0050	76mm	50
0002.1249 / 8734.9195.0060	76mm	60
0002.1250 / 8734.9195.0080	76mm	80
8734.9195.0120	76mm	120

## siafix Quick Change Backing Pads



Mfct part number	Size (mm)
0002.2210	25mm
0020.8066	50mm
0020.8069.01	76mm

## 6270 Surface Conditioning Discs



The new 6270 SCM range with high-performance blue fired aluminium oxide grain and improved low stretch scrim helps deliver longer lifetime and faster working in both discs and belts.

#### Features:

Excellent and consistent finish over a long period of time. More durable so more resistant on edges. Suitable for general use in dry and wet sanding applications. Considerably more resistant to smearing than existing products; especially at the edge of the disc when working at tight angles

#### Applications:

Deburring. Removing rust and paint. Removing discolouration. Surface finishing. Finishing to prepare for coating and electroplating

Mfct part number	Size (mm)	Grit
6335.2710.2921	50mm	Coarse A
6335.2710.4921	50mm	Medium A
6335.2710.5921	50mm	Fine A
6335.2710.6921	50mm	Very Fine A

6884.4655.2921	76mm	Coarse A
6884.4655.4921	76mm	Medium A
6884.4655.5921	76mm	Fine A
6884.4655.6921	76mm	Very Fine A



Mfct part number	Size (mm)	Grit
4441.6601.2921	100x 16mm	Coarse A
4441.6601.4921	100x 16mm	Medium A
4441.6601.5921	100x 16mm	Fine A
4441.6601.6921	100x 16mm	Very Fine A

4892.0370.2921	115 x 22mm	Coarse A
4892.0370.4921	115 x 22mm	Medium A
4892.0370.5921	115 x 22mm	Fine A
4892.0370.6921	115 x 22mm	Very Fine A

## 6120 siafleece Hand Pads

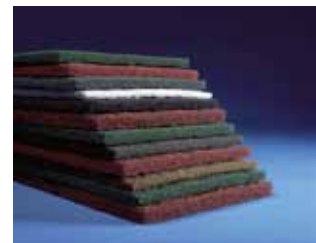

For even surface finishes 6120 siafleece can be used for dry and wet sanding and impresses due to its high conformability, consistent performance over the entire lifetime, low tendency to clog, and consistently high surface quality

These high quality hand pads are an excellent performer for metal finishing and are constructed in such a way that the grit fully penetrates the whole of the non-woven fibres which gives extended life to the product and better value for money.

#### Applications:

Blending and regaining. Removing discolouration. Structuring/finishing. Cleaning of flat or contoured surfaces

Mfct part number	Size (mm)	Grit
4132.9840.2922.52	152 x 229mm	Extra Cut
4132.9840.4721.37	152 x 229mm	Med S

4132.9840.6923	152 x 229mm	General Purpose
4132.9840.6921.13	152 x 229mm	Very Fine A
4132.9840.8715.12	152 x 229mm	Ultra Fine S



We pioneer motion

## Mounting, dismounting, maintenance and lubrication



### For every step of your bearing's life.

The correct mounting and dismounting of rolling bearings can save time and dramatically increase the life of bearings, as well as maximising the availability of critical plant and machinery by avoiding costly breakdowns. Correct alignment and lubrication can achieve improved energy efficiency of machines and equipment.

[www.schaeffler.co.uk](http://www.schaeffler.co.uk)

**SCHAEFFLER**



We pioneer motion

## Reliable tools for mounting and dismantling

### **Mounting and dismantling of rolling bearings**

For the economical and secure mounting of rolling bearings Schaeffler provides various devices as well as mounting paste for the mounting of bearings in all designs using mechanical, thermal and hydraulic methods.

Schaeffler also offers a mounting service with experts who have detailed knowledge and extensive experience in all industrial sectors.

The on-line Mounting Manager is available for the correct mounting of bearings with tapered bore and is accessed via our website and Medias.

[www.schaeffler.co.uk](http://www.schaeffler.co.uk)

**SCHAEFFLER**

We pioneer motion

## Induction heating devices for safe and reliable mounting of bearings



### Your benefits

- User-friendly operation via modern touch screen
- More productivity with time savings of 30-50%
- Energy consumption cut by up to 50%

### Features

- Automatic power regulation and sensor detection
- The heating process can be documented
- Four different heating modes
- Delta T control ensures safe heating of bearings

[www.schaeffler.co.uk](http://www.schaeffler.co.uk)

**SCHAEFFLER**

We pioneer motion

## CONCEPT Series refillable auto lubricators



**Savings for the planet and in your pocket too.**

The CONCEPT series from Schaeffler with 1 to 8 lubrication points, helping reduce your environmental impact.

Flexible : CONCEPT refillable cartridges for your choice of lubricant.

Environmentally friendly : As the cartridges can be filled up to three times, plastic waste is reduced.

Easily re-filled : using either a grease gun or from a barrel.

[www.schaeffler.co.uk](http://www.schaeffler.co.uk)

**SCHAEFFLER**

We pioneer motion

## Lubrication



### **Arcanol rolling bearing greases.**

The correct choice of lubricant has a significant influence on the function and lifespan of a rolling bearing. Schaeffler Arcanol greases offer superior performance and are divided into four groups:

- Multi-purpose greases: for a wide range of applications
- Heavy-duty greases: for particularly high demands on load carrying capacity
- High-temperature greases: for operating temperatures up to 200° C
- Special greases: for specific application requirements

[www.schaeffler.co.uk](http://www.schaeffler.co.uk)

**SCHAEFFLER**

We pioneer motion

# Grease selection for typical applications

Designation	Characteristic applications	Operating temperature °C		Continuous limit temperature	Thickener	Base Oil	Consistency NLGI	Base oil viscosity at +40°C mm <sup>2</sup> /s	Temperatures		Low friction, high speed	High load, low speed	Vibrations	Support for seals	Relubrication facility					
		From	To						High	Low										
<b>Multipurpose greases</b>	MULTITOP	Ball and roller bearings in rolling mills, construction machinery, automotive engineering, spinning and grinding spindles			-50)	+140	+80	Lithium soap	Partially synthetic oil	2	82	++	+	+	++	+	•	++		
	MULTI2	Ball bearings up to 62 mm outside diameter in small electric motors, agricultural and construction machinery, household appliances			-30	+120	+75	Lithium soap	Mineral oil	2	110	+	•	•	•	•	•	•	++	
	MULTI3	Ball bearings from 62 mm outside diameter in large electric motors, agricultural and construction machinery, ventilators			-30	+120	+75	Lithium soap	Mineral oil	3	80	+	•	•	•	+	+	+	+	
<b>High Loads</b>	LOAD150	Ball, roller, and needle roller bearings, linear guidance systems in machine tools			-20	+140	+95	Lithium complex soap	Mineral oil	2	160	•	+	—	++	+	+	+	+	
	LOAD220	Ball and roller bearings in rolling mills, rail vehicles, paper machinery			-20	+140	+80	Lithium/calcium soap	Mineral oil	2	245	•	+	—	++	+	+	+	+	
	LOAD400	Ball and roller bearings in mining machinery, construction machinery, main bearings for wind turbines			-40	+130	+80	Lithium/calcium soap	Mineral oil	2	400	•	•	—	++	+	+	+	+	
	LOAD460	Ball and roller bearings, wind turbines, bearings with pin-type cage			-40)	+130	+80	Lithium/calcium soap	Mineral oil	1	400	+	•	—	++	+	—	+	+	
	LOAD1000	Ball and roller bearings in mining machinery, construction machinery, cement plants			-30)	+130	+80	Lithium/calcium soap	Mineral oil	2	1000	•	•	—	++	+	+	+	+	
<b>High temperature ranges</b>	TEMP90	Ball and roller bearings in clutches, electric motors, automotive engineering			-40	+160	+90	Poly-carbamide	Partially synthetic oil	3	148	++	+	•	•	•	•	+	+	
	TEMP110	Ball and roller bearings in electrical equipment, automotive engineering			-35	+160	+110	Lithium complex soap	Partially synthetic oil	2	130	++	++	+	•	•	•	•	•	
	TEMP120	Ball and roller bearings in continuous casting plants, paper machinery			-30	+180	+120	Poly-carbamide	Synthetic oil	2	400	+	++	—	++	•	+	•	•	
	TEMP200	Ball and roller bearings in guide rollers in baking machinery, kiln trucks and chemical plants, piston pins in compressors			-30	+260	+200													
	PTFE	Alkoxy fluoro oil			2	550	+	++	---	+	•	•	•							
<b>Special greases</b>	SPEED2,6	Ball bearings in machine tools, spindle bearings, rotary table bearings, instrument bearings			-40	+120	+80	Lithium complex soap	Synthetic oil	2 – 3	25	++	•	++	---	—	•	•		
	VIB3	Ball and roller bearings in blade adjusters in wind turbine rotors, packaging machinery, rail vehicles			-30	+150	+90	Lithium complex soap	Mineral oil	3	170	+	+	—	+	++	+	—	—	
	FOOD2	Ball and roller bearings in applications with food contact (NSF-H1 registration, kosher and halal certification)			-30	+120	+70	Aluminum complex soap	Synthetic oil	2	150	+	—	•	•	•	•	•	++	
	CLEAN-M	Ball, roller, and needle roller bearings as well as linear guidance systems in clean room applications			-30	+180	+90	Poly-carbamide	Ether oil	2	103	++	++	•	•	•	•	•	+	
	MOTION2	Ball and roller bearings in oscillating operation, slewing rings in wind turbines			-40	+130	+75	Lithium soap	Synthetic oil	2	50	++	•	—	+	++	+	•	•	

MAINTENANCE & CONDITION MONITORING



We pioneer motion

## Condition Monitoring Products to increase plant availability



As you are aware associated costs of downtime can range from £15,000 per hour for a cement plant, to £60,000 per hour for a steel mill. Machines that are not monitored at all, or only monitored manually, are an uncontrolled risk.

With experience in machine building and manufacturing of rotating products, Schaeffler has specialist knowledge when it comes to monitoring machines. With a portfolio of condition monitoring (CM) products and industry 4.0 service solutions Schaeffler's goal is to enable the monitoring of all machines in an affordable way.

[www.schaeffler.co.uk](http://www.schaeffler.co.uk)

**SCHAEFFLER**

We pioneer motion

## SmartCheck



FAG SmartCheck is a cost-effective, innovative online measuring system for the continuous monitoring of machine and process parameters on a decentralised basis. It offers the performance features of expensive systems but is compact in design, easy to fit and simple to use.

The SmartCheck is suitable for early detection of rolling bearing damage, imbalances and misalignments on electric and geared motors, vacuum and fluid pumps, ventilators and fans, gearboxes and compressors, spindles and machine tools.

[www.schaeffler.co.uk](http://www.schaeffler.co.uk)

**SCHAEFFLER**

We pioneer motion

## ProLink CMS versatile, modular and easy to integrate



### The ProLink multi-channel condition monitoring system for continual machine monitoring via vibration measurement.

- Templates for monitoring rolling bearings, motors, gearboxes, fans, and pumps that make further configuration easier.
- The learning mode allows for adjustments to alarm thresholds to optimise monitoring
- Optional use of the ConditionAnalyzer via the integrated cloud interface.

[www.schaeffler.co.uk](http://www.schaeffler.co.uk)

**SCHAEFFLER**

We pioneer motion

# OPTIME

## Plug - Play - Predict



OPTIME is a high scale monitoring solution allowing for comprehensive condition monitoring that is both easy and affordable. It's simple plug & play installation, allows you to start monitoring hundreds of rotating machines in just a few hours. With the ability to work on almost all machines, OPTIME can detect potential damage, imbalances or misalignments – even weeks in advance.

[www.schaeffler.co.uk](http://www.schaeffler.co.uk)

**SCHAEFFLER**

MAINTENANCE  
& CONDITION  
MONITORING



SIP Stock a wide range of Premium Brands, all of which come with a 3 YEAR WARRANTY.

www.sip-group.com



**DEWALT**



**WORKSHOP FANS, AIR MOVERS & WET/DRY VACUUMS**

SIP is a distributor for DeWALT Wet/Dry Vacuums and Industrial Air products

**HELVI** FROM SIP INDUSTRIAL WELDING EQUIPMENT



ARC/MMA Welders • TIG Inverter Welders  
MIG Transformer Based Welders • MIG Inverter Welders  
MIG Multi-Process Welders • Plasma Cutters

**NARDI COMPRESSORI**

**NARDI Compressori**  
INDUSTRIAL OIL-FREE  
AIR COMPRESSORS



LOW PRESSURE COMPRESSORS | HIGH PRESSURE BREATHING COMPRESSORS | DENTAL COMPRESSORS | NITROGEN BOOSTERS | CNG COMPRESSORS

**aer service** FROM SIP



**PROFESSIONAL EXHAUST GAS FUME EXTRACTORS**

**LEMANIAENERGY** Switzerland



**BOOSTER PACKS, BATTERY SUPPORT UNITS, BATTERY CHARGERS & STARTERS, BATTERY TESTERS & SCANNERS**

**WINNTEC** FROM SIP



WINNTEC FROM SIP  
**3 YEARS WARRANTY**  
INCLUDES WEAR AND TEAR



**AUTOMOTIVE & COMMERCIAL LIFTING EQUIPMENT**

MAINTENANCE & CONDITION MONITORING

## SIP INDUSTRIAL PRODUCTS LIMITED

For over 50 years, SIP Industrial Products Limited, has been a flagship supplier of high quality equipment and machinery to the ever-growing, engineering, construction, automotive & agricultural marketplaces.



**AIR COMPRESSORS**



**STARTERS & BOOSTER PACKS**



**PRESSURE WASHERS**



**CLEANING**



**WATER PUMPS**



**AUTOMOTIVE & LIFTING**



**HEATING**



**WELDING & METALWORK**



**WOODWORKING**



SIP (INDUSTRIAL PRODUCTS) LIMITED

[www.sip-group.com](http://www.sip-group.com)



MAINTENANCE  
& CONDITION  
MONITORING

Tel: +44 (0)1299 266 800  
 UK & IRELAND SALES Tel: 01299 269 500  
 Email: [info@parweld.co.uk](mailto:info@parweld.co.uk)



## MIG INVERTER WELDING MACHINES

### XTM 211Di 4in1

#### KEY FEATURES

Large high quality colour screen with multi language easy to follow digital interface.

View and adjust machine parameters from the MIG and TIG torch handle.

HF Start TIG.

Instant swapping between MIG and TIG process with one touch of the torch trigger.

Rapid synergic setup for MIG, TIG and MMA.

MIG Weld, down to 0.9mm thick material.

Memory function for all processes to save and recall welding programs.

Pulse TIG function for superior arc control.

5 kg and 15 kg (300mm) Spool Size.

Welding Capacity (230V input).



DUAL VOLTAGE  
 INSTANT SWAPPING  
 BETWEEN PROCESSES  
 RAPID SYNERGIC SETUP  
 FOR MIG, TIG & MMA  
 LARGE HIGH QUALITY  
 COLOUR SCREEN

DESIGNED & QUALITY ASSURED  
 BY PARWELD ENGLAND UK

### MESH BACK DRIVERS GLOVE



COW GRAIN LEATHER  
 STOCK CODE P3854  
 SIZE 10

### PANTHER GAUNTLET



COW SPLIT LEATHER  
 STOCK CODE P3825  
 SIZE 10

### PANTHER PRO TIG GLOVE



GOAT SKIN WITH COW HIDE  
 CUFF AND REAR  
 STOCK CODE P3839  
 SIZE 10

### CANADIAN RIGGER GLOVE



COW SKIN & COTTON  
 STOCK CODE P3805  
 SIZE 10

### PRO LONG SLEEVE GAUNTLET



COW GRAIN LEATHER  
 STOCK CODE P3822  
 SIZE 10

### XTM 201i

#### KEY FEATURES

230V single phase.

200A @ 25% duty cycle.

Compact and portable.

Synergic MIG.

Lift TIG and MMA.

Accepts 5kg (200mm) spools.

IP23S.

Supplied with 3m Earth Lead.

2T/4T trigger latching.



MULTI PROCESS  
 MIG/MMA / LIFT TIG  
 SYNERGIC CONTROL  
 DUAL DIGITAL  
 DISPLAY

### XTE 201C

#### KEY FEATURES

230V single phase.

205A @ 15% duty cycle.

2 Roll drive.

Forced air fan cooling.

Infinitely variable wire speed.

Overload warning indicator.

Polarity can be changed for gas-less welding.

Stand for gas cylinder (half bottle).

Holds 5 kg and 15 kg wire spools.

Built-in gas valve.



SINGLE PHASE  
 EURO TORCH  
 CONNECTOR  
 2 ROLL METAL  
 FEED BOX  
 8 VOLTAGE STEPS

Tel: +44 (0)1299 266 800  
 UK & IRELAND SALES Tel: 01299 269 500  
 Email: info@parweld.co.uk



## TIG WELDING MACHINES

DESIGNED & QUALITY ASSURED  
 BY PARWELD ENGLAND UK

### XTT 207 DV

#### KEY FEATURES

- Pulse function for superior arc control.
- Dual voltage 110-230V 1P.
- Lightweight 8 kg.
- 200A @ 35% duty cycle.
- Generator friendly.
- Adjustable TIG parameters.
- Supplied with 3m earth lead.
- Adjustable down slope option (TIG mode).
- Connections 35-50mm dinse.



TIG WELDS STEEL &  
 STAINLESS STEEL TO 6MM  
 DUAL VOLTAGE 110/230V  
 PULSE FUNCTION  
 FOR SUPERIOR ARC  
 CONTROL

### XTT 212P AC/DC

#### KEY FEATURES

- Pulse function for superior arc control.
- 110V or 230V Input.
- TIG welds any metal up to 6mm.
- Square wave AC TIG.
- Variable frequency for faster welding.
- Reduced footprint.



110V OR 230V INPUT  
 TIG WELDS ANY  
 METAL UP TO 6MM  
 SQUARE WAVE AC TIG  
 PULSE FUNCTION  
 TO SUPERIOR  
 ARC CONTROL

## MMA WELDING MACHINES

### XTS 163

#### KEY FEATURES

- 230V input.
- Lightweight 4.7 kg.
- 160A @ 25% duty cycle.
- Electrode striking with arc force and re-striking with hot start.
- Supplied with electrode holder, 3m cable & 3m earth lead.
- Connections 35-50mm dinse.
- Digital amperage display.
- Over voltage and over current protection.



DIGITAL DISPLAY  
 FOR EASY SETTING  
 GENERATOR FRIENDLY  
 LIFT ARC TIG

### XTS 204

#### KEY FEATURES

- 230V input.
- 200A @ 25% duty cycle.
- Generator friendly.
- Easy electrode striking with arc force & re-striking with hot start.
- Supplied with electrode holder, 3m cable & 3m earth lead.
- Connections 35-50mm dinse.
- Over voltage and over current protection.



DIGITAL DISPLAY  
 FOR EASY SETTING  
 LIFT ARC TIG MODE

## INVERTER PLASMA CUTTER MACHINES

### XTP 40

#### KEY FEATURES

- Lightweight 12.6 kg.
- 40A @ 40% duty cycle.
- Generator friendly.
- Smart switching dual voltage 110-230V.
- Ideal for mesh cutting.
- Supplied with XT4000 plasma torch x 6m and 3m earth cable.
- Auto over voltage and over current protection.
- Includes built-in air pressure regulator.



CUTS ANY METAL  
 12MM  
 PRODUCTION CUT  
 20MM  
 SEVERANCE CUT  
 DUAL VOLTAGE  
 110/230V

### XTP 63

#### KEY FEATURES

- 400V 3 phase.
- Lightweight 13 kg.
- 60A @ 40% duty cycle.
- Generator friendly.
- Ideal for mesh cutting.
- Supplied with XT4000 plasma torch 6m and 3m earth cable.
- Auto over voltage and over current protection.
- Includes built-in air pressure regulator and pressure gauge.



CUTS ANY METAL  
 20MM  
 PRODUCTION CUT  
 30MM  
 SEVERANCE CUT  
 COMPACT AND  
 LIGHTWEIGHT

WELDING



Tel: +44 (0)1299 266 800  
 UK & IRELAND SALES Tel: 01299 269 500  
 Email: [info@parweld.co.uk](mailto:info@parweld.co.uk)



**DESIGNED & QUALITY ASSURED  
 BY PARWELD ENGLAND UK**

## WELDING AND GRINDING HELMETS

### XR935H



**EVERYDAY LIGHT  
 REACTIVE**

#### KEY FEATURES

- Automatic light adjustment from light to dark in 1/30,000th of a second.
- Shade control from DIN9-13.
- Variable sensitivity.
- Grinding mode.
- Variable delay.
- Viewing area 100mm x 41mm (3.94 x 1.62").
- Full face coverage.
- Automatic power on/off.
- Built-in battery.
- UV/IR protection up to shade DIN 16.
- 12 Months warranty.

### XR939H



**TRUE COLOUR  
 LIGHT REACTIVE**

#### KEY FEATURES

- ADF flips up inside helmet.
- Automatic darkening.
- Variable shade 4-to-13.
- ADF exceptional clarity and optical quality rated 1/1/1/1 EN 379.
- External controls.
- Variable sensitivity and delay.
- Automatic on and off, solar cells and built-in battery.
- Front visor for high impact protection.
- Clear state 3.0 for exceptional pre-weld clarity.
- 24 Months warranty.

### XR938H

(6 colour options)



**TRUE COLOUR  
 LIGHT REACTIVE**

#### KEY FEATURES

- True colour lens.
- Slim and lightweight.
- Automatic light adjustment from light to dark in 1/30,000th of a second.
- Shade control from DIN5-13.
- Variable sensitivity.
- Grinding mode.
- Variable delay.
- Viewing area 100 x 52mm (3.94 x 2.05").
- Suitable for TIG welding.
- Automatic power on/off.
- 24 Months warranty.

## POWERED AIR PURIFYING RESPIRATOR (PAPR)



#### PAPR COMES WITH A TWO HELMET OPTION

- Supplied with either a  
**XR950A (XR1052)**  
 Flip Filter Helmet or  
**XR940A (XR1002)**  
 Large View Welding Helmet

TH3P R SL particulate filter removes 99.8% of welding fume particulates, dust, smoke and aerosol.

**XR950A**  
 FLIP FILTER

**XR940A**  
 LARGE VIEW

Tel: +44 (0)1299 266 800  
 UK & IRELAND SALES Tel: 01299 269 500  
 Email: [info@parweld.co.uk](mailto:info@parweld.co.uk)



## MIG, TIG & PLASMA TORCH RANGE

DESIGNED & QUALITY ASSURED  
 BY PARWELD ENGLAND UK



Parweld's torch range features a number of important factors which are fundamental to the functionality, usability, and service life of our torches.

### Ergonomically Superior Handle Designs

**Cable Supports** combine the ultimate in balance, positioning, and ergonomics.

### Cable Systems

Hyper-flex<sup>®</sup> coaxial cable offers outstanding flexibility and the highest heat and abrasion resistance specification.

*(See website for full range of torches)*



## GAS CUTTING EQUIPMENT

A wide range of gas cutting and welding equipment including regulators, torches, nozzles and accessories.



WELDING  
**WIRE**

## OFFICIAL UK SUPPLIER FOR RUKO AND MAGMAWELD



WELDING



**Selected by Professionals**

Founded in 1991 and celebrating our 30th anniversary, Specialised Welding Products (SWP) is firmly established as one of the UK's leading suppliers of Welding and Safety Equipment, whilst maintaining core beliefs of Quality, Service and Value, delivered by a dedicated team with extensive product knowledge.

Our new 2,332m<sup>2</sup> National Distribution Centre is based in Haydock, just off the M6 at Junction 23, where we stock over 10,000 products. From here you can collect your orders personally at the Trade Counter or order by phone, online or via our app up to 7pm for next day nationwide delivery of quality products allied to the welding industry – and beyond.



NATIONAL DISTRIBUTION CENTRE Haydock, UK

## PRODUCT BRANDS

We offer a range of our own brands to provide the welder with a choice of products based on their quality and price requirements. All SWP brands comply with legislative requirements and have been rigorously tested and approved by end users around the world.



## MANUFACTURER'S BRANDS

SWP partner with world leading brands to offer the best choice of welding products.



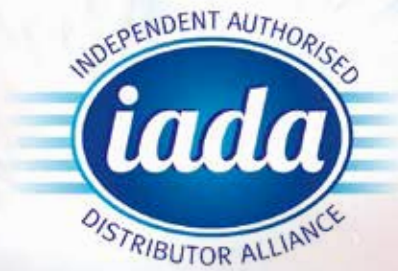

# PREMIUM GLASSES

**bolle**  
SAFETY



26 g

## RUSH+

- + UPPER PROTECTION
- + CO-INJECTED, ULTRA-FLEX TEMPLES
- + NON-SLIP ADJUSTABLE BRIDGE
- + BI-COLOUR TEMPLES DEPENDING ON VERSION
- + 'PLATINUM' ANTI-FOG & ANTI-SCRATCH COATING

SKU	VERSION	LENS MARKING	FRAME MARKING	COATING
RUSHPPSI	Clear	2C-1.2 1FT KN C€	EN166 FT C€	Anti-scratch/Anti-fog
RUSHPPSF	Smoke	5-3.1 1FT KN C€	EN166 FT C€	Anti-scratch/Anti-fog
RUSHPCSP	CSP	5-1.4 1FT KN C€	EN166 FT C€	Anti-scratch/Anti-fog



21 g

## CONTOUR

- + NON-SLIP BRIDGE
- + NON-SLIP TIPGRIP TEMPLES
- + ANTI-STATIC
- + 'PLATINUM' ANTI-FOG & ANTI-SCRATCH COATING

SKU	VERSION	LENS MARKING	FRAME MARKING	COATING
*CONTPSI	Clear	2C-1.2 1FT KN C€	EN166 FT C€	Anti-scratch/Anti-fog
*CONTPSF	Smoke	5-2.5 1FT KN C€	EN166 FT C€	Anti-scratch/Anti-fog
*PSSCONT-C10	CSP	5-1.4 1FT KN C€	EN166 FT C€	Anti-scratch/Anti-fog

All these products are supplied with a microfibre bag



21 g

## SILIUM+

- + ULTRA LIGHTWEIGHT FRAME
- + NON-SLIP ADJUSTABLE BRIDGE
- + STRAIGHT, HIGHLY FLEXIBLE ERGONOMIC TEMPLES
- + ALL-ROUND VISION
- + 'PLATINUM' ANTI-FOG & ANTI-SCRATCH COATING

SKU	VERSION	LENS MARKING	FRAME MARKING	COATING
SILPPSI	Clear	2C-1.2 1FT KN C€	EN166 FT C€	Anti-scratch/Anti-fog
SILPPSF	Smoke	5-3.1 1FT KN C€	EN166 FT C€	Anti-scratch/Anti-fog
SILPCSP	CSP	5-1.4 1FT KN C€	EN166 FT C€	Anti-scratch/Anti-fog

All these products are supplied with a microfibre bag

'PLATINUM': Bollé Safety's exclusive anti-fog and anti-scratch coating is applied on both sides of the lens. Resistant to the most extreme work environments, this coating ensures an optimal vision and goes beyond every international standard requirements (EN166 K&N rated).

# CORE GLASSES

**bolle**  
SAFETY

## SILEX



30 g



- + ULTRA-WRAPAROUND FRAME
- + PC/TPR CO-INJECTED TEMPLES FOR GREATER COMFORT
- + PANORAMIC FIELD OF VISION
- + FLEX 160° TEMPLES

SKU	VERSION	LENS MARKING	FRAME MARKING	COATING
SILEXPSI	Clear	2C-1.2  1FT C €	EN166 FT C €	Anti-scratch/Anti-fog
SILEXPSF	Smoke	5-3.1  1FT C €	EN166 FT C €	Anti-scratch/Anti-fog
SILEXPSJ	Yellow	2C-1.2  1FT C €	EN166 FT C €	Anti-scratch/Anti-fog

## RUSH



25 g



- + UPPER PROTECTION
- + ADJUSTABLE NON-SLIP BRIDGE
- + NON-SLIP TEMPLES

SKU	VERSION	LENS MARKING	FRAME MARKING	COATING
RUSHPSI	Clear	2C-1.2  1FT C €	EN166 FT C €	Anti-scratch/Anti-fog
RUSHPSF	Smoke	5-3.1  1FT KN C €	EN166 FT C €	Anti-scratch/Anti-fog

## BL30



24 g



- + UPPER PROTECTION
- + STOP-IN SYSTEM (ON THE HINGE OF THE TEMPLES)
- + WITHOUT ANY SCREWS
- + ANTI-FOG & ANTI-SCRATCH COATING ON BOTH SIDES OF THE LENSES

## BL11



46 g

- + SIDE SHIELDS WITH A VENTILATION SYSTEM
- + COMPATIBLE WITH ALL PRESCRIPTION GLASSES

SKU	VERSION	LENS MARKING	FRAME MARKING	COATING
PSSBL30-014	BL30 Clear	2C-1.2  1FT C €	EN166 FT C €	ASAF
PSSBL30-408	BL30 Smoke	5-2.5  1FT C €	EN166 FT C €	ASAF
BL11PI	BL11	2C-1.2  1FT C €	EN166 FT C €	-

# HYBRIDS & GOGGLES

**bolle**  
SAFETY

## TRACKER



52 g

- + LOWER AND UPPER PROTECTION
- + SIDE VENTILATION
- + REMOVABLE ADJUSTABLE STRAP
- + 'PLATINUM' ANTI-FOG & ANTI-SCRATCH COATING

SKU	VERSION	LENS MARKING	FRAME MARKING	COATING
*TRACPSI	Clear	2C-1.2  1BT KN CE	Temples version: EN166 FT CE	Anti-scratch/Anti-fog
*TRACPSF	Smoke	5-2.5  1BT KN CE	Strap version: EN166 3 4 BT CE	Anti-scratch/Anti-fog
*TRACPSJ	Yellow	5-1.4  1BT KN CE		Anti-scratch/Anti-fog

All these products are supplied with a microfibre bag

## COBRA



25 g

- + UPPER PROTECTION
- + PANORAMIC VISION
- + NON-SLIP BRIDGE & PIVOTING TEMPLES
- + TEMPLE OR STRAP VERSION WITH INTERCHANGEABLE FOAM
- + 'PLATINUM' ANTI-FOG & ANTI-SCRATCH COATING

SKU	VERSION	LENS MARKING	FRAME MARKING	COATING
COBFSPSI	Foam and strap	2C-1.2  1BT KN CE	EN166 3 BT CE	Anti-scratch/Anti-fog
COBFTPSI	Foam and temples	2C-1.2  1BT KN CE	EN166 FT CE	Anti-scratch/Anti-fog

COBFSPSI is supplied with a microfibre bag

## SUPERBLAST



113 g

- + ALL-ROUND VISION
- + FITS OVER PRESCRIPTION GLASSES
- + COMPATIBLE WITH HALF-MASK RESPIRATOR
- + 'PLATINUM' ANTI-FOG & ANTI-SCRATCH COATING

## ATOM



74 g

- + FITS OVER PRESCRIPTION GLASSES
- + THERMO PLASTIC RUBBER (TPR)
- + OVERFLOW CHUTE FOR LIQUIDS
- + 'PLATINUM' ANTI-FOG & ANTI-SCRATCH COATING

SKU	VERSION	LENS MARKING	FRAME MARKING	COATING
SUPBLASP	Ventilated	2C-1.2  1 9 BT KN CE	EN166 3 4 9 BT CE	Anti-scratch/Anti-fog
SUPBLV	Visor for SUPERBLAST	-	EN166 3 BT CE	-
ATOAPSI	Ventilated	2C-1.2  1BT KN CE	EN166 3 BT CE	Anti-rayures/Anti-buée
ATOV	Visor for ATOM	-	EN166 3 BT CE	-

WORKWEAR & PPE

# ACCESSORIES



## CLEANING WIPES

*B-clean by bolle safety is a complete and efficient cleaning solutions range. Its formula guarantees perfect cleaning and protection for your glasses and goggles.*

- + **AQUA FORMULA**
- + **ALCOHOL AND SILICONE FREE**
- + **FOR ALL TYPES OF LENSES**

SKU	VERSION
PACW100	100 cleaning premoistened tissues dispenser
PACW500	500 cleaning premoistened tissues dispenser



## CASE

SKU	VERSION	SIZE & WEIGHT
ETUIB	Black polyester case with belt clip and belt loop	190 x 80 x 75 - 23g



# ALL INCLUSIVE PRESCRIPTION PACK

**PRESCRIPTION SAFETY GLASSES EASY AS 1, 2, 3...**

- 1 Take the pack to your local optician**  
It includes everything you need!
- 2 Choose your frame**  
16 styles to pick from!
- 3 Your optician will order them** and tell you when they are ready\*

(\* excludes eye test fee)

**ENJOY WEARING YOUR PROTECTION !**



Copyright Bolle Safety - F. Bourcier

bolle-safety.com

**WORKWEAR & PPE**



Choose to reuse!

Real Reusable FFP Masks



Storage case



**Air Seal** can be used for several days!\*

- Foam Seal

**Air Plus** can be used for a week!\*

- TPE Seal

Developed for long periods of use

- ✓ Top of the range
- ✓ Save money
- ✓ The greener choice

Conform to: EN 149:2001+ A1:2009

Code	Valve	Description	Units / Box
3308 <sub>01</sub>	•	FFP2 R D	5
3408 <sub>01</sub>	•	FFP3 R D (individually packaged)	5
3705 <sub>01</sub>	•	FFP3 R D (individually packaged)	8
3994 <sub>01</sub>		FFPak storage case	1

\* Usage time is subject to concentrations and breathing resistance, the respirator should be disposed of and replaced if breathing resistance becomes excessive



## MOLDEX

### Classic

Disposable Respirator available in FFP1, FFP2 & FFP3



- ✓ Reliable protection against particles
- ✓ ActivForm® - 3D fit for a secure seal
- ✓ DuraMesh® - Mesh structure retains shape
- ✓ Ventex®-Valve reduces heat and humidity
- ✓ Loop strap for easy application and tension distribution
- ✓ Fits securely without the need for a nose clip
- ✓ Conform to: EN 149:2001+ A1:2009

Code	Valve	Description	Units / Box	Code	Valve	Description	Units / Box
236015		Classic FFP1 NR D	20	240015		Classic FFP2 NR D	20
236515	•	Classic FFP1 NR D	20	240515	•	Classic FFP2 NR D	20
				255501	•	Classic FFP3 NR D	20

## MOLDEX

### Smart

Disposable Respirator available in FFP1, FFP2 & FFP3



- ✓ Reliable protection against particles
- ✓ Soft nose cushion for increased comfort
- ✓ ActivForm® - 3D fit for a secure seal
- ✓ DuraMesh® - Mesh structure retains shape
- ✓ Ventex®-Valve reduces heat and humidity
- ✓ Clip fastening allows the mask to be hung around the neck when not in use
- ✓ Fits securely without the need for a nose clip
- ✓ Conform to: EN 149:2001+ A1:2009

Code	Valve	Description	Units / Box	Code	Valve	Description	Units / Box
238001		Smart FFP1 NR D	20	248001		Smart FFP2 NR D	20
238501	•	Smart FFP1 NR D	20	248501	•	Smart FFP2 NR D	20
				250501	•	Smart FFP3 NR D	10

## MOLDEX

### AIR Series

Sized Disposable Respirator available in FFP2 & FFP3

Available in TWO sizes! With AirWave® filter for extremely low breathing resistance

- ✓ Reliable protection against particles
- ✓ Tested to equivalent medical standard, type IIR [non valved only]
- ✓ AirWave® filter for extremely low breathing resistance
- ✓ Available in two sizes for a secure fit
- ✓ ActivForm® - 3D fit for a secure seal
- ✓ DuraMesh® - Mesh structure retains shape
- ✓ Optional Ventex®-Valve reduces heat and humidity
- ✓ Fits securely without the need for a nose clip
- ✓ Conform to: EN 149:2001+ A1:2009

airwave®  
filter technology

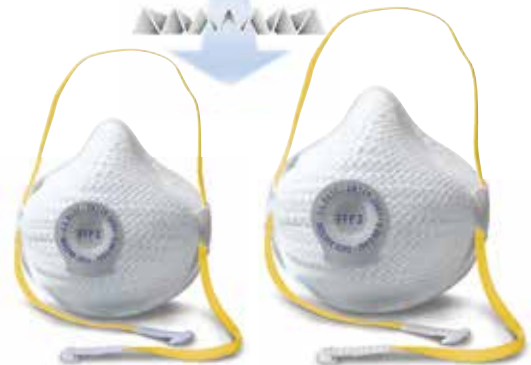

Code	Valve	Description	Units / Box	Code	Valve	Description	Units / Box
310001		FFP2 NR D size M/L	10	320001		FFP3 NR D size M/L	10
315001		FFP2 NR D size S	10	325001		FFP3 NR D size S	10
310501	•	FFP2 NR D size M/L	10	320501	•	FFP3 NR D size M/L	10
315501	•	FFP2 NR D size S	10	325501	•	FFP3 NR D size S	10

## MOLDEX

### Bitter Fit Test Kit

Moldex Fit Test Kits allow employers to take charge of their own Fit Testing programme thereby reducing costs and enabling them to carry out Fit Testing whenever necessary [new employee, change of RPE etc]. Each Moldex kit is suitable for carrying out multiple tests and comes packaged in its own sturdy case.

#### Fit Testing Kit contains:

1 x Hood, 6 x 2.5ml bitter sensitivity solution ampoules, 6 x 2.5ml bitter test solution ampoules, 2 x nebulisers, 2 x crushing sleeves, 1 x Fit Test instructions

Code	Description	Units / Box
010301	Fit Test Kit	1
050301	Bitter Sensitivity Solution 2.5ml	6
050401	Bitter Test Solution 2.5ml	6



## MOLDEX

### Series 7000

Reusable Half Mask



- ✓ Reliable protection against gas, vapour and particles
- ✓ Available in soft TPE or Silicone which remains stable at extreme temperatures
- ✓ Use with EasyLock® filters, easy to install and combine. No adapters or clips needed
- ✓ Easy maintenance and cleaning
- ✓ Lightweight with excellent field of vision
- ✓ Head piece and straps are adjustable for a comfortable and secure fit
- ✓ Conform to: EN 140:1998

Code	Description	Units / Box
7001 <sub>01</sub>	TPE Mask body [S]	1
7002 <sub>01</sub>	TPE Mask body [M]	1
7003 <sub>01</sub>	TPE Mask body [L]	1

Code	Description	Units / Box
7001 <sub>01</sub>	Silicone Mask body [S]	1
7002 <sub>01</sub>	Silicone Mask body [M]	1
7003 <sub>01</sub>	Silicone Mask body [L]	1

## MOLDEX

### Series 9000

Reusable Full Face Mask



- ✓ Reliable protection against gas, vapour and particles
- ✓ Use with EasyLock® filters, easy to install and combine. No adapters or clips needed
- ✓ Frameless panoramic lens for a large field of vision
- ✓ Scratchproof and solvent-resistant lens protects the eyes
- ✓ Easy maintenance and cleaning
- ✓ Lightweight yet hard wearing and fulfills the stringent requirements of Class 2
- ✓ Conform to: EN 136:1998 CL2

Code	Description	Units / Box
9001 <sub>01</sub>	Mask body [S]	1
9002 <sub>01</sub>	Mask body [M]	1
9003 <sub>01</sub>	Mask body [L]	1

## MOLDEX

### EasyLock® Particulate Filters

Series 7000 and 9000 particulate filters



#### EASYLOCK®

- ✓ No adapters
- ✓ Easy handling
- ✓ Simpler logistics - 30% less parts
- ✓ AirWave® for extremely low breathing resistance and high absorption capacity
- ✓ Conform to: EN143:2000 + A1:2006

EasyLock® gas and particulate filters feature bayonet connections that can either be combined or fitted directly onto the Series 7000 and 9000 mask bodies without the need for adapters or filter holders.

Particulate Filters		
Code	Description	Units / Box
9020 <sub>01</sub>	P2 R D	20
9022 <sub>01</sub>	P2 R D + ozone	12

Particulate Filters		
Code	Description	Units / Box
9030 <sub>01</sub>	P3 R D	12
9032 <sub>01</sub>	P3 R D + ozone	12

## MOLDEX

### EasyLock® Gas Filters

Series 7000 and 9000 gas filters



#### EASYLOCK®

- ✓ No adapters
- ✓ Easy handling
- ✓ Simpler logistics - 30% less parts
- ✓ Conform to: EN14387:2004 + A1:2008

EasyLock® gas and particulate filters feature bayonet connections that can either be combined or fitted directly onto the Series 7000 and 9000 mask bodies without the need for adapters or filter holders.

Gas Filters		
Code	Description	Units / Box
9100 <sub>01</sub>	A1 gas filter	10
9200 <sub>01</sub>	A2 gas filter	8
9300 <sub>01</sub>	ABE1 gas filter	10

Gas Filters		
Code	Description	Units / Box
9400 <sub>01</sub>	ABEK1 gas filter	10
9600 <sub>01</sub>	AX gas filter [single use]	8
9800 <sub>01</sub>	ABEK2 gas filter*	8

\*ABEK2 when combined with P2 or P3 particulate filters must only be used with the Series 9000 Full Face Mask and not the Series 7000 Half Mask

## MOLDEX

### CompactMask

Maintenance Free Half Mask

- ✓ Reliable protection against gas, vapour and particles
- ✓ Maintenance free and ready to use
- ✓ Ultra compact design offers excellent field of vision
- ✓ Push to test valve allows the user to check the fit of the mask
- ✓ Compatible with additional PPE like visors and goggles
- ✓ FlexFit, automatically adjusts to different face shapes
- ✓ Mask body is gentle on the skin
- ✓ Available with the following filters: FFA1P2 R D, FFA2P3 R D, FFABE1P3 R D and FFABEK1P3 R D
- ✓ Conform to: EN 405:2001 + A1:2009



Conforms to: EN 405:2001+ A1:2009

Code	Description	Units / Box
5120 <sub>01</sub>	FFA1P2 R D	10
5230 <sub>01</sub>	FFA2P3 R D	10
5330 <sub>01</sub>	FFABE1P3 R D	10
5430 <sub>01</sub>	FFABEK1P3 R D	10

## MOLDEX

### Spark Plugs® Disposable Earplugs

SNR  
**35**  
dB



- ✓ Maintain a secure and comfortable fit
- ✓ Bright and colourful
- ✓ Made from soft comfortable PU foam
- ✓ Easy to roll and insert
- ✓ Available uncorded [7801]
- ✓ SNR 35dB
- ✓ Conform to: EN352-2:2002

Code	Description	Pairs / Box
780001	Spark Plugs® SNR 35	200
780101	Spark Plugs® Cord SNR 35	200

## MOLDEX

### Spark Plugs® MoldexStations Earplug Dispenser

SNR  
**35**  
dB



- ✓ Maintain a secure and comfortable fit
- ✓ Bright and colourful
- ✓ Plugs remain hygienic as the dispenser mechanism is automatically replaced with every refill
- ✓ Dispenses only one or two earplugs at a time
- ✓ Bracket available separately [706001]
- ✓ 250 or 500 pairs per station
- ✓ SNR 35
- ✓ Conform to: EN352-2:2002

Code	Description	Pairs / Station
782501	MoldexStation [250] SNR 35	250
785001	MoldexStation [500] SNR 35	500
706001	Mounting Bracket	1 unit

## MOLDEX

### Twisters® Semi Reusable Earplugs

SNR  
**34**  
dB



- ✓ Solid handle for easy insertion and removal
- ✓ Hygienic application without rolling
- ✓ Multi curved stem rotates for a custom fit
- ✓ Semi reusable - clean with mild soapy water between use
- ✓ SNR 34dB
- ✓ Conform to: EN 352-2:2002

Code	Description	Pairs / Box
644101	Twisters® SNR 34	80

## MOLDEX

### Twister® Trio Reusable Earplugs

SNR  
**33**  
dB



- ✓ Solid handle for easy insertion and removal
- ✓ Hygienic application without rolling
- ✓ Multi curved stem rotates for a custom fit
- ✓ Can be washed and reused
- ✓ Comes in a hygienic PocketPak® storage container
- ✓ SNR 33dB
- ✓ Conform to: EN 352-2:2002

Code	Description	Pairs / Box
645101	Twisters® Trio SNR 33	50

## MOLDEX

### Banded Earplugs Conform to: EN 352-2:2002

SNR  
**27**  
dB

SNR  
**23**  
dB



#### WaveBand 1K

- ✓ Shape mimics the lower jaw, reducing contact and transmission noise to the ear
- ✓ Soft plugs and low band pressure
- ✓ Foam pods are replaceable [682501]
- ✓ SNR 27dB

#### Jazz Band®2

- ✓ Sits securely and comfortably under the chin
- ✓ Neck cord with safety release mechanism
- ✓ Soft plugs and low band pressure
- ✓ Foam pods are replaceable [682501]
- ✓ SNR 23dB

Code	Description	Units / Box
681001	WaveBand 1K SNR 27	8
670002	Jazz Band® 2 SNR 23	8
682501	Replaceable pods [50 pairs]	50

## MOLDEX

### M-Series Earmuffs

SNR  
**30**  
dB

SNR  
**34**  
dB

SNR  
**35**  
dB



- ✓ High quality and robust earmuff
- ✓ Low profile design
- ✓ Lightweight and flexible
- ✓ Low contact pressure
- ✓ Simple on-head size adjustment
- ✓ Soft ear cushions with extra wide ear space for increased fit and comfort
- ✓ Conform to: EN 352-1:2002

Code	Description	Units / Box
611001	M4 SNR 30 [yellow]	1
612001	M5 SNR 34 [blue]	1
613001	M6 SNR 35 [black]	1
614001	MX7 SNR 31 [blue]	1

# PERSONAL PROTECTIVE EQUIPMENT SPECIALISTS

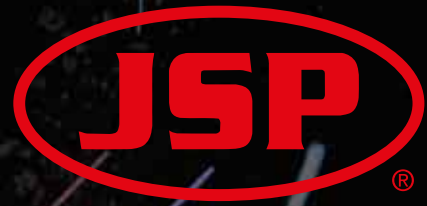

Established in 1964, JSP is internationally recognised as the leading manufacturer of innovative 'above the neck' Personal Protective Equipment specialising in Head, Eye, Face, Hearing, Respiratory Protection and Height Safety Products.

With state-of-the-art manufacturing and testing facilities in 7 factories over 3 continents, JSP is committed to improving occupational safety, health and wellbeing of people in the workplace worldwide, and has been voted European leader in Industrial Head Protection by Frost and Sullivan.

JSP safety helmets, hearing and respiratory protection, and eyewear can be customised according to individual specifications using corporate logos and colour schemes, safety messages, personal names and identity systems.

Sustainability is of great importance to JSP and by continually improving the methodologies used during manufacture, designing products to be recyclable, and concentrating on Product Lifecycle Management, JSP will help to ensure a safer, more sustainable future.



## FORCE™ FACE MASKS & PRESSTOCHECK™ FILTERS

Our full range of PressToCheck™ filters are sleek and low profile, enabling maximum compatibility with other JSP products such as the EVOGuard® visor range. PressToCheck™ filters are for use with both the Force™8 half mask and Force™10 Typhoon™ full face mask.



FORCE10™

TYPHOON™



FORCE8™



evoVista®

## EVO® VISTA® HELMET RANGE

Our EVO®VISTALens® and EVO®VISTAshield® helmets are also fully compatible with Force™8 Half Mask, SpringFit™ Disposable Mask and Sonis® Helmet Mounted Ear Defenders.



**JSP** DigiHUB

**KNOWLEDGE  
AT YOUR  
FINGERTIPS**





Feel the difference.™

## MegaMan®

### Features & Benefits

- DriTek® lining wicks moisture away from the hand
- EcoTek® biodegradable technology
- Lasts up to 5x longer than conventional nitrile gloves
- Fully textured finish provides excellent wet & dry grip
- Touchscreen compatible
- Food Approved nitrile glove

**Thickness** - 8.5mil (0.22mm) | **Length** - 11.0" (280mm) | **AQL** - 1.5



N66088

## PowerForm® Teal

### Features & Benefits

- EcoTek® biodegradable technology
- Silicone-free formulation prevents contamination
- Textured finish for excellent wet and dry grip
- Beaded cuff allows for easy donning & removal
- Touchscreen compatible
- Food Approved nitrile glove

**Thickness** - 8.5mil (0.22mm) | **Length** - 9.5" (242mm) | **AQL** - 1.5



N20036

## PowerForm® Black

### Features & Benefits

- EcoTek® biodegradable technology
- Fully textured surface provides excellent wet & dry grip
- Beaded cuff allows for easy donning & removal
- Pure nitrile prevents latex allergic reaction
- Touchscreen compatible
- Food Approved nitrile glove

**Thickness** - 5mil (0.13mm) | **Length** - 9.0" (229mm) | **AQL** - 1.5



N71688

## ORANGE GRIPPER®

### Features & Benefits

- Tyre tread pattern for excellent grip
- Chemical resistant
- Powder free
- Food Approved nitrile glove

**Thickness** - 0.18mm | **Length** - 240mm | **AQL** - 1.5



7181

Exclusively available from  
Keypoint Industrial Solutions  
[www.keypoint-uk.co.uk](http://www.keypoint-uk.co.uk)

**Keypoint**  
Protecting you at work

**MaxiFlex®** is designed and developed as a breathable glove and has become the benchmark for precision handling in dry environments by combining outstanding comfort with class leading durability.

## MaxiFlex® ULTIMATE™



Code 42-874  
Coating Palm Coated  
EN 388 4131A  
Sizes 5-12



**NOW**  
TOUCH SCREEN  
COMPATIBLE

World's favourite versatile work glove with unrivalled fingertip dexterity

## MaxiFlex® ENDURANCE™



Code 42-848  
Coating Dotted Palm  
EN 388 4131A  
Sizes 6-12



**NOW**  
TOUCH SCREEN  
COMPATIBLE

Visible orange liner with raised dots for extra cushioning & grip

## MaxiFlex® ENDURANCE™



Code 42-847  
Coating Driver Dotted Palm  
EN 388 4131A  
Sizes 6-12



**NOW**  
TOUCH SCREEN  
COMPATIBLE

Fully coated glove with dotted palm for exceptional grip and long service life

## MaxiFlex® ELITE™



Code 34-274  
Coating Palm Coated  
EN 388 4121A  
Sizes 6-11

Ultra lightweight glove weighing only 14grams. 30% thinner than traditional foam nitrile gloves

KEEPING HOT HANDS  
COOL, DRY and PRODUCTIVE

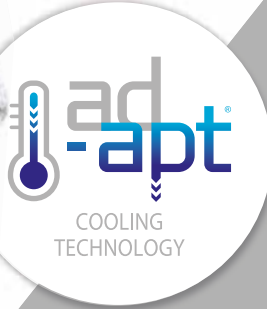

Exclusively available from  
Keypoint Industrial Solutions  
[www.keypoint-uk.co.uk](http://www.keypoint-uk.co.uk)

**Keypoint**  
Protecting you at work

WORKWEAR  
& PPE



**MaxiCut®** has been designed for people needing cut protection in challenging environments. They are DMF free and guaranteed free from SVHCs (REACH).

## MaxiFlex® CUT™



Code 34-8743  
Coating Palm Coated  
EN 388 4331B  
Sizes 6-12



**NOW**  
TOUCH SCREEN  
COMPATIBLE

Ultra lightweight and breathable medium cut protection glove. Extremely durable with excellent grip

## MaxiCut® ULTRA™



Code 44-3745  
Coating Palm Coated  
EN 388 4542C  
Sizes 6-12



**NOW**  
TOUCH SCREEN  
COMPATIBLE

Cut level 5 breathable glove with the feel of an assembly glove, yet extremely durable

## MaxiCut® OIL™



Code 44-305  
Coating 3/4 Coated  
EN 388 4341B  
Sizes 6-11

Medium cut protection double dipped glove with excellent grip in wet & oily environments

## MaxiCut® OIL™



Code 44-505  
Coating 3/4 Coated  
EN 388 4442C  
Sizes 6-11

High cut protection double dipped glove with excellent grip in wet & oily environments

## MaxiFlex® MaxiFlex® MaxiCut® CUT™ ULTRA™



**NOW**

TOUCH SCREEN  
COMPATIBLE

Exclusively available from  
Keypoint Industrial Solutions  
[www.keypoint-uk.co.uk](http://www.keypoint-uk.co.uk)

**Keypoint**  
Protecting you at work

MaxiDry® range blends comfort and grip with protection from oils providing you a controlled performance in these difficult conditions.

## MaxiDry®



Code 56-425  
Coating 3/4 Coated  
EN 388 4121A  
Sizes 6-11

Lightweight double dipped liquid repellent glove with excellent dexterity. Extremely flexible and dexterous with excellent abrasion resistance

## MaxiDry®



Code 56-427  
Coating Fully Coated  
EN 388 4121A  
Sizes 7-12

Lightweight double dipped fully coated liquid repellent glove with excellent dexterity. Extremely flexible and dexterous with excellent abrasion resistance

## MaxiDry®



Code 56-426  
Coating Gauntlet  
EN 388 4111A  
Sizes 6-11

Lightweight double dipped liquid repellent gauntlet with unbelievable flexibility & dexterity

## MaxiTherm®



Code 30-201  
Coating Palm Coated  
EN 388 1241B  
Sizes 6-11

Thermal lined glove for general handling in cold conditions. Latex coating gives excellent grip in wet or dry conditions



## MaxiDry®

**Controlled Performance in WET or OILY Environments**



Exclusively available from  
Keypoint Industrial Solutions  
[www.keypoint-uk.co.uk](http://www.keypoint-uk.co.uk)

**Keypoint**  
Protecting you at work

WORKWEAR  
& PPE

# PORTWEST®



**Stretch your limits with Portwest's most dynamic workwear collection yet.** This contemporary collection combines all the technical features required of modern workwear, with many clever innovations to ensure the wearer achieves maximum function and style. The DX4™ collection combines high performance stretch fabrics with robust oxford panels to provide unparalleled ease of movement and supreme flexibility. What defines this collection is the cutting edge designs which allow for a full crossover from work to leisure activity.

Discover more about this collection [www.portwest.com](http://www.portwest.com)

# PORTWEST®



Portwest KX3™ is a superior line of trend-led apparel combining quality construction to the highest standards and technical fabrics. Key characteristics within this collection include abrasion resistance, moisture management and stretch fabrics for sustained agility and effortless movement. All KX3 garments have been designed to fully complement each other to allow a personal layering system to be built. A perfect solution for modern workwear.

Discover more about this collection [www.portwest.com](http://www.portwest.com)

# PORTWEST®



Portwest WX3™ technical stretch workwear balances comfort, versatility and aesthetics. Products are designed to the highest standards and offer a solution for everyday activity and working environments. Constructed with cutting edge fabrics giving superior abrasion resistance and exceptional all-day comfort. Ingenious design solutions on fastenings and pocketing systems give unrivalled fit and security.

# PORTWEST®

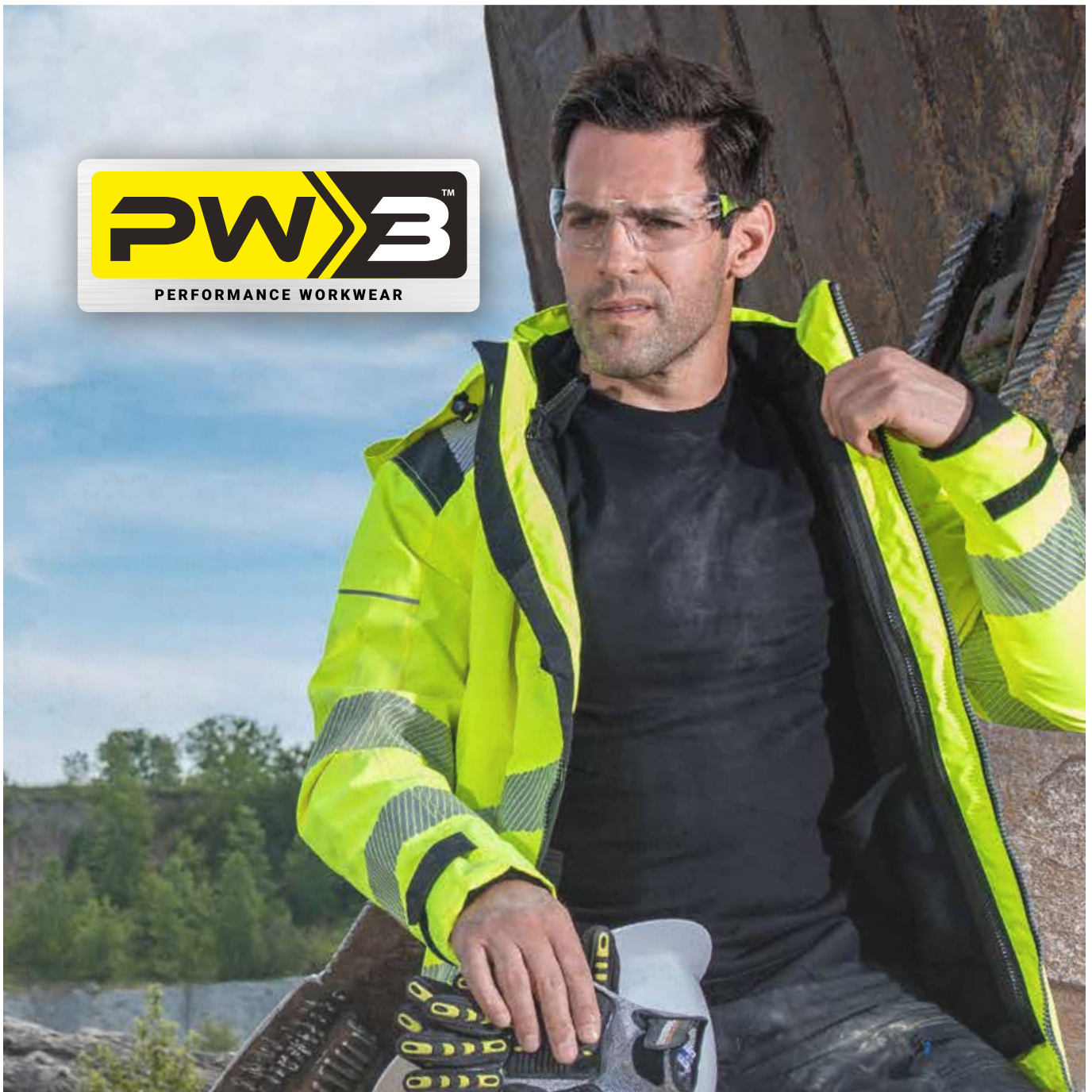

Portwest PW3 workwear is characterised by fresh dynamic designs and a contemporary fit. A selection of premium fabrics and advanced construction techniques have been used, guaranteeing choice, comfort and ultimate wearer durability. The garments have been tested to ensure they will withstand the rigours of everyday wear.

Discover more about this collection [www.portwest.com](http://www.portwest.com)



Established in 2007, Base Protection footwear is one of Europe's leading brands of safety footwear, who design and manufacture exceptional safety shoes for millions of wearers globally. Base Protection's mission is to improve the wellbeing of the workers through innovation and technology. At the core of this is their focus on comfort.

By **PORTWEST**

# PORTWEST®

## ESSENTIAL INDUSTRY QUALITY SAFETY FOOTWEAR



The extensive range of Portwest footwear offers a wide choice of industry leading styles, engineered for performance and ergonomically designed for maximum comfort, protection and reliability. Strong and flexible construction, providing longer lasting, superb fitting footwear that will withstand the test of time.

Discover more about this collection [www.portwest.com](http://www.portwest.com)



# FIREXO



firexo

A **REVOLUTION** IN FIRE FIGHTING

## ALL FIRES ONE ANSWER

- Extinguish **any** type of fire with **one** fire extinguisher
- Protect **people** and **places**
- Eco safe** and more **environmentally friendly**



FX-SA

FX-50SA

### PAN FIRE SACHET



FX-6L

FX-9L

FX-M

FX-2L

### EXTINGUISHERS

### BUNDLES



FX-SASIGN

FX-EXTSIGN

### SAFETY SIGNS



FX-RESTAURANT



FX-BOAT



FX-SMKITCHEN



FX-HOME



FX-CARAVAN

Fire Type						
Class A = Combustible paper/ wood	✓	✓	✓	✗	✓	✓
Class B = Flammable Liquids Petrol Diesel	✗	✓	✓	✓	✗	✓
Class C = Gases	✗	✗	✓	✗	✗	✓
Class D = Metal & Magnesium	✗	✗	✓	✗	✗	✓
Electrical	✗	✗	✓	✓	✗	✓
Class F = Fats and Oils	✗	✗	✗	✗	✓	✓

WORKWEAR  
& PPE

# FIRE RETARDANT



## TESLA FR ANTI-STATIC HI-VISIBILITY BOILERSUIT

- Multi purpose 'utilities' boilersuit
- 320gsm fabric
- 80% Cotton 19% Polyester 1% anti-static
- 2 Vertical side access hip pockets
- 1 left breast pocket with sewn down flap
- Concealed stud fly front to neck
- Plain back
- Internal knee pouch pockets
- Elastic to waist
- Plain cuffs and ankles
- Retro-reflective tape
- FR/AS embroidery to right sleeve

CFRASTEBS 36" - 58" / 91cm - 147cm



**EN1149-5: 2008**  
Anti Static - Material performance and design requirements

**EN ISO 20471: 2013**  
Class 3 high visibility

**EN ISO 11612: 2008**  
(A1 B1 C1) - Protection against heat and flame

## FR BOILERSUIT NORDIC DESIGN

- 300 gram 100% cotton drill fabric with flame retardant treatment
- FR reflective tape (Nordic Pattern)
- Concealed stud front to neck
- One left breast pocket with flap
- Two front hip pockets
- Knee pad pockets
- Plain back and hips

CFRBSND 36" - 60" / 91cm - 152cm



**EN ISO 11612: 2015**  
(A1 B1 C1) - Protection against heat and flame

**EN ISO 11611: 2015**  
(Class 1 A1) - Protective clothing for use in welding



## FR REGULAR BOILERSUIT

- 300 gram 100% cotton drill fabric with flame retardant treatment
- Concealed stud front to neck
- One left breast pocket with flap
- Two front hip pockets
- Plain back and hips
- Embroidered 'FR' logo to upper left sleeve
- One garment per polybag
- Ten garments per carton

CFRBS 36" - 60" / 91cm - 152cm



**EN ISO 11612: 2015**  
(A1 B1 C1) - Protection against heat and flame

**EN ISO 11611: 2015**  
(Class 1 A1) - Protective clothing for use in welding



## FR TROUSERS



- 300 gram cotton drill fabric with flame retardant treatment
- Brass zip fly
- Button waistband fastening
- 7 Belt loops
- Two vertical side seam access pockets
- Plain back and hips
- FR logo embroidered to left hip

CFRT 30" - 48" / 76cm - 121cm



**EN ISO 11612: 2015**  
(A1 B1 C1) - Protection against heat and flame

**EN ISO 11611: 2015**  
(Class 1 A1) - Protective clothing for use in welding

## TESLA FR ANTI-STATIC HI-VIS TROUSERS



- 320gsm Hi Vis FR treated fabric with anti static grid
- YKK Brass zip fly
- Brass hook and bar waistband fastening
- 7 Belt loops
- Two vertical side seam access pockets
- 2 Bands retro reflective tape to legs
- FR & AS logos embroidered to left hip
- Plain ankles
- Available in tall leg (T) option

CFRASET 28" - 48" / 71cm - 121cm



**EN1149-5: 2008**  
Anti Static - Material performance and design requirements

**EN ISO 20471: 2013**  
Class 1 high visibility

**EN ISO 11612: 2015**  
(A1 B1 C1) - Protective against heat and flame

beeswift.com

WORKWEAR & PPE

## HIGH VISIBILITY



### TWO TONE SOFT SHELL JACKET

HVTT040 S - 4XL

- Lightweight & comfortable
- Windproof
- Fleece backed, breathable fabric
- Full length front zip to neck
- 2 Angled zipped hip pockets
- Zipped right breast pocket
- Retro-reflective segmented tape

EN ISO 20471  
Class 3 high visibility  
RIS-3279-TOM ISSUE 1  
(Orange only) Railway use tested



EN ISO 20471  
Class 3 high visibility  
RIS-3279-TOM ISSUE 1  
(Orange only) Railway use tested

### TWO TONE SWEATSHIRT

HVTT020 S - 4XL

- 280 gsm fleece fabric
- 100% polyester
- Anti pill (the fabric has been treated to prevent little balls (or pills) of thread appearing on the surface of the fabric)
- Handwarmer pockets
- Retro-reflective segmented tape
- 2 bands around chest and arms with shoulder accents

### TWO TONE HOODY

HVTT025 S - 4XL

EN ISO 20471  
Class 3 high visibility  
RIS-3279-TOM ISSUE 1  
(Orange only) Railway use tested

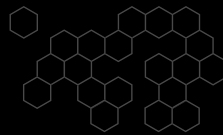

### TWO TONE SHORT SLEEVE POLO SHIRT

HVTT010 S - 4XL

EN ISO 20471  
Class 2 high visibility  
RIS-3279-TOM ISSUE 1  
(Orange only) Railway use tested

- 100% Bird Eye Polyester fabric
- 3 Button placket
- Retro-reflective segmented tape



### TWO TONE LONG SLEEVE POLO SHIRT

HVTT015 S - 4XL

EN ISO 20471  
Class 3 high visibility  
RIS-3279-TOM ISSUE 1  
(Orange only) Railway use tested

- 100% Bird Eye Polyester fabric
- Retro-reflective segmented tape



### TWO TONE TROUSERS

HVTT080 UK 28" - 44" / EU 44 - 60

- 80-20 polyester cotton
- Seven loop belt waistband
- 2 x hip pockets
- 1 x left leg cargo pocket
- 2 x rear pocket
- Knee pad pouch pockets
- Hard wearing and durable
- ID pocket
- Available in regular, short and tall leg fit

EN ISO 20471  
Class 1 high visibility  
RIS-3279-TOM ISSUE 1  
(Orange only) Railway use tested



### TWO TONE LONG SLEEVE T-SHIRT

HVTT005 S - 4XL

EN ISO 20471  
Class 3 high visibility

- 100% Bird Eye Polyester fabric
- Retro-reflective segmented tape



### TWO TONE SHORT SLEEVE T-SHIRT

HVTT001 S - 4XL

EN ISO 20471  
Class 2 high visibility



# HIGH VISIBILITY



## PU JACKET

PUJ S - 4XL



- Breathable fabric
- Polyester with PU coating
- Concealed hood
- Full zip front with double storm flap
- Self double yoke back
- Lower pockets with flap
- Elasticated storm cuffs
- Stitched and welded seams
- Reflective material



EN ISO 20471  
Class 3 high visibility

EN 343  
Class 3 water penetration resistant  
Class 1 air permeability

## PUT EN ISO 20471 TROUSERS

PUT S - 4XL



- Breathable fabric
- Polyester with PU coating
- Overtrousers with elasticated waist
- Studded ankles
- 3M® retro-reflective tape



EN ISO 20471  
Class 2 high visibility

EN 343  
Class 3 water penetration resistant  
Class 1 air permeability

CTJFL S - 4XL

- PU coated polyester
- Fleece lined
- Concealed hood
- Retro-reflective tape
- Two-way heavy-duty zip front, storm flap and security pocket
- 2 Lower pockets with flaps
- Right hand chest pocket with flap
- Inside breast pocket
- Knitted storm cuffs
- Internal 'wicking' strip
- Fully taped seams

EN ISO 20471  
Class 3 high visibility

EN 343  
Class 3 water penetration resistant  
Class 1 air permeability

## FLEECE LINED TRAFFIC JACKET



TJFS S - 4XL

- Heavyweight PU coated polyester
- Nylon lining
- Concealed hood
- Two-way heavyweight zip with storm flap
- 2 lower hip pockets with flaps
- Knitted storm cuffs
- Fully taped seams
- Reversible bodywarmer 'zipout'
- 3M® retro-reflective tape

EN ISO 20471  
Class 1 high visibility  
RIS-3279-TOM ISSUE 1  
(Orange only) Railway use tested

EN 343  
Class 3 water penetration resistant  
Class 1 air permeability

EN ISO 20471  
Class 2 high visibility  
(Bodywarmer only)

## 4 IN 1 TRAFFIC JACKET & BODYWARMER



## CONSTRUCTOR TRAFFIC JACKET

CTJENG S - 4XL



- PU coated polyester
- Quilted lining with heavyweight (160gsm) polyester filling
- Concealed hood
- Two-way heavy-duty zip front with storm flap and security pocket
- 2 Lower pockets with flaps
- Inside breast pocket
- Knitted storm cuffs
- Internal 'wicking' strip
- Fully taped seams
- Retro-reflective material

EN ISO 20471  
Class 3 high visibility

EN 343  
Class 3 water penetration resistant  
Class 1 air permeability

## EUROPA BOMBER JACKET

EBJ S - 4XL



- 100% polyester with non-breathable coating
- Removable sleeves
- Detachable fleece liner
- Unlined hood with drawcord
- Plastic zip with internal storm flap
- Pen pocket to upper left sleeve
- Exposed ribbed cuffs and waist band
- Mobile phone pocket to right breast
- 2 lower front bellows pockets
- 2 hand warmer pockets
- Retro-reflective tape

EN ISO 20471  
Class 3 (with sleeves)  
Class 2 (without sleeves)

EN 343  
Class 3 water penetration resistant  
Class 1 air permeability

## ETON SOFT SHELL JACKET

ET40/41 S - 4XL

- Hi-vis "Soft Shell" jacket
- Water resistant, windproof
- Fleece backed, breathable fabric
- 2 hand warmer front pockets
- Adjustable cuffs
- 6cm retro-reflective tape
- Retro-reflective piping
- Spiral wound front zip to neck
- Hip drawcord
- Lightweight
- Stylish and comfortable

EN ISO 20471  
Class 3 high visibility



ET45/46 S - 4XL

- Breathable PU coated fabric
- Waterproof jacket fully taped seams
- Zip front closure to neck
- Hook & loop fastening storm flap
- Adjustable cuffs
- 6cm retro-reflective tape
- Retro-reflective piping
- 2 zip fastening front pockets
- Concealed hood
- Hip drawcord

EN ISO 20471  
Class 1 high visibility  
RIS-3279-TOM ISSUE 1  
(Orange only) Railway use tested

EN 343  
Class 3 water penetration resistant  
Class 3 air permeability



## ETON BREATHABLE JACKET



beeswift.com

WORKWEAR & PPE



## HIGH VISIBILITY + WORKWEAR

### LIGHTWEIGHT EN ISO 20471 SUIT



TS8 S - 4XL

- PVC coated 150D polyester
- Concealed hood
- Two-way heavy-duty zip front with studded storm flap
- 2 Lower pockets with flaps
- Knitted storm cuffs
- Fully taped seams

- PVC coated 150D polyester
- Elasticated waist
- 2 position stud adjustment to legs
- 2 Side pockets with storm flaps
- Fully taped seams



EN ISO 20471  
Class 3  
high visibility



EN 343  
Class 3 water  
penetration resistant  
Class 1 air permeability

BPKLSSEN S - 4XL Long Sleeve



BPKSEN S - 4XL Short Sleeve



- 100% polyester "Bird Eye" fabric
- 3 button placket
- Grey trim to collar and cuffs
- Retro-reflective tape

EN ISO 20471  
Class 3 high visibility (Long sleeve)  
Class 2 high visibility (Short sleeve)  
RIS-3279-TOM ISSUE 1  
(Orange only) Railway use tested

### HI-VIS POLO SHIRT LONG / SHORT SLEEVE



### HOODED SWEATSHIRT



BSHSEN S - 3XL

- 280gsm fleece fabric
- 100% polyester
- Full length front zip
- Handwarmer pockets
- Retro-reflective sew on tape
- Two band & brace



EN ISO 20471  
Class 3 high visibility  
RIS-3279-TOM ISSUE 1  
(Orange only) Railway use tested

HVWCTT M - 3XL



### TWO TONE EXECUTIVE WAISTCOAT



- 100% polyester
- Front zip fastening
- Two large front pockets with flaps
- Mobile phone pocket with hook & loop fastening flap
- Radio loop, pen & pencil pockets
- Transparent I.D. pouch pocket
- Retro-reflective tape
- Covered mesh back panel



EN ISO 20471  
Class 1 high visibility

### HI-VISIBILITY WAISTCOAT



WCENG M - 6XL

- 100% polyester
- Hook & loop fastening
- Retro-reflective tape
- 2 body bands
- 2 braces



EN ISO 20471  
Class 2 high visibility

### GRANTHAM MULTI-POCKET SHORTS



GMPSN 30" - 48" / 76cm - 121cm

- 98% cotton 2% lycra stretch fabric
- YKK zip fastening with metal button
- waistband attachment
- 7 belt loops
- Triple stitching to main seams
- 2 front hip pockets
- 2 front detachable tool (nail) pouches
- 1 multi cargo pocket to thigh, metal stud fastening, including mobile phone pocket
- 1 rear patch pocket with hook & loop fastening
- 1 Cordura rule pocket

### CLICK BOILERSUIT



PCBS 34" - 54" / 86cm - 137cm



- 65% polyester 35% cotton
- Lay down collar
- Yoke back
- Concealed stud front
- 2 breast pockets with stud flap
- 2 lower welted pockets
- 2" (5cm) waistband with side elastication

### SUPER CLICK BOILERSUIT



PCBSHW 36" - 54" / 91cm - 137cm



- 65% polyester 35% cotton
- Concealed two-way zip
- 2 zip breast pockets
- Reinforced elasticated waist
- Double pen pocket on sleeve
- 2 swing hip pockets with side access
- 2 rear pockets, one with hook & loop fastening
- 1 rule pocket, 1 hammer loop

**WORKWEAR + WEATHERPROOF**



**SHAWBURY MULTI-POCKET TROUSERS**



SMPT 30" - 50" / 76cm - 127cm



- Polycotton twill fabric
- Multi-pocket design with tool pouches
- Tuck away holster pockets
- 1 rear pocket with hook & loop flap
- Hammer loop
- External knee pad pouches
- Reinforced knees
- Side elastic on waist for comfort and ease of fitting
- 30cm gusset at ankles with zip closure
- Available in regular and tall fit (T)

**KINGTON MULTI-POCKET TROUSERS**



KMPT 28" - 48" / 71cm - 121cm



- 98% cotton / 2% lycra stretch fabric
- YKK zip fastening with metal button
- waistband attachment
- 7 belt loops
- Triple stitching to main seams
- 2 front hip pockets, 2 detachable tool (nail) pouches
- 1 multi cargo pocket to thigh, hook & loop fastening, including mobile phone pocket
- 2 rear patch pockets with hook & loop fastening
- Cordura knee pad pockets
- 1 Cordura rule pocket
- Cordura heel reinforcement
- Available in regular and tall (T) sizes

**NYLON B-DRI SUIT PACK**



**Jacket:**

- Lightweight nylon with PVC coating to the inside
- Zip front
- Concealed Hood
- lower front pocket with flaps
- Studded cuffs
- Hip drawcord
- Fully taped seams

**Trousers:**

- Elasticated waist
- Access to pockets
- Stud fastening to ankles
- Fully taped seams

NBDS S - 5XL



**SALESBURY WATERPROOF COVERALL**



- Zip front covered by a double storm flap with press studs
- Fixed hood
- Wind cuffs
- Elasticated waist
- Adjustable leg opening with press studs
- Lightweight and durable
- 170gsm PU coated polyester fabric
- Multi-use garment for agriculture, industrial and leisure

HYD018500 S - 4XL



EN 343 Class 3 water penetration resistant Class 1 air permeability

**SANDHURST WATERPROOF BIB & BRACE**



- Adjustable elastic shoulder braces
- Adjustable leg openings with press studs
- 170gsm PU coated polyester fabric
- Lightweight and durable
- Multi-use garment for agriculture, industrial and leisure

HYD014045 S - 4XL



EN 343 Class 3 water penetration resistant Class 1 air permeability

**ULFT WATERPROOF JACKET**



- Zip front with storm flap cover and press stud closure
- Fixed hood
- Elasticated cuffs with press stud closure
- 2 front pockets with flap
- Mesh polyester lining
- Simply No Sweat (SNS) 210gsm polyester laminate fabric
- Highly breathable providing great comfort
- Durable and cost effective
- Smooth polyester textile finish

HYD072400 S - 4XL



EN 343 Class 4 water penetration resistant Class 4 air permeability

**UTRECHT WATERPROOF TROUSERS**



- Elasticated waist with drawcord
- Mesh polyester lining
- Adjustable leg opening with press studs
- Simply No Sweat (SNS) 210gsm polyester laminate fabric
- Highly breathable providing great comfort
- Durable and cost effective
- Smooth polyester textile finish

HYD072350 S - 4XL



EN 343 Class 4 water penetration resistant Class 4 air permeability

beeswift.com

WORKWEAR & PPE

## DISPOSABLE



### VIRA-CHEM DISPOSABLE COVERALL

COCN4013EW S - 2XL

Protects against:

- Chemical & Viral agents
- Bloodborne pathogens
- Sulphuric acid
- Contaminated liquids
- Radioactive Contamination
- For fine dust particles, reduced spray and limited splash
- Anti-static
- 2 way zip front with storm flap
- Elasticated cuffs, ankles, waist and hood
- Microporous fabric 54% polypropylene + 46% polyethylene
- Individually packaged

EN 13034: 2005 + A1: 2009  
EN 13982-1: 2005 + A1: 2010

EN1149-5: 2008  
Anti Static - Material performance and design requirements

EN 1073-2: 2002  
Protective clothing against radioactive contamination (no rays)

EN 14126: 2003 + AC: 2004  
Protective clothing against infective agents (Type 4B, 5B, 6B)



### MICROPOROUS TYPE 3/4/5/6 DISPOSABLE COVERALL

COC40 S - 3XL

- 90gm 56% SMS polypropylene, 44% polyethylene
- Polyethylene laminated +3 layers of polypropylene
- Ultrasonic taped seams
- Elasticated hood, wrists, ankles and waist
- Zip front with storm flap
- Elasticated thumb loops

EN 13034: 2005 + A1: 2009  
EN 13982-1: 2005 + A1: 2010  
EN 14605: 2005 + A1: 2009

EN1149-5: 2008  
Anti Static - Material performance and design requirements

EN 1073-2: 2002  
Protective clothing against radioactive contamination (no rays)

EN 14126: 2003 + AC: 2004  
Protective clothing against infective agents (Type 4B, 5B, 6B)



### POLYPROP COVERALL

PP45 L - 2XL

- 90gm 56% SMS polypropylene, 44% polyethylene
- Polyethylene laminated +3 layers of polypropylene
- Ultrasonic taped seams
- Elasticated hood, wrists, ankles and waist
- Zip front with storm flap
- Elasticated thumb loops



### NITRILE DISPOSABLE GLOVES POWDER FREE

- CE category III
- CE class I examination glove
- Suitable for catering, beauty and body art sectors
- Free from phthalates/softeners, allergenic latex proteins

NDGPF50 S(7) = XL (10)

EN 374-1 EN 374-5

### DISPOSABLE GRIPPER GLOVE

GZNDG10BL S (7) - XXL (11)

- Powder free
- CE category III
- Excellent elasticity
- Textured for added grip

EN 374-1: 2016

EN 374-5: 2016



### VINYL DISPOSABLE GLOVES

- 100% synthetic PVC
- Contains no latex or protein
- Ambidextrous
- Easy to pull on beaded cuff
- Available Pre-powdered and Powder free

VDG S(7) = XL (10)

EN 374-1: 2016



### SNOOD CAP

DSCW500 ONE SIZE



### HAIRNET

DH ONE SIZE

Detectable



### MOB CAP

DMC ONE SIZE

Detectable



### BEARD SNOOD

DBS ONE SIZE

Detectable



### 16 INCH (40CM) DISPOSABLE OVERSHOES

DOS ONE SIZE

Economy

### 14 INCH (35CM) OVERSLEEVES

D014 ONE SIZE

Detectable



beeswift.com

# FOOTWEAR



## WATERPROOF SIDE ZIP BOT

CF68NB UK 6 - 12 / EU 39 - 45

- Poron XRD internal M-Guard
- TPU protective scuff cap
- YKK heavy duty side zip
- Waterproof membrane lining



## 6 INCH BOOT

CF2BL UK 6 - 13 / EU 39 - 48

- Smooth leather
- Dual density PU



TPU heel support



## TRADERS CHUKKA BOOT

CTF32/33 UK 6 - 12 / EU 39 - 47

- Dual density
- EVA / Rubber



## TRADERS THINSULATE BOOT

CTF24BL UK 6 - 13 / EU 39 - 48

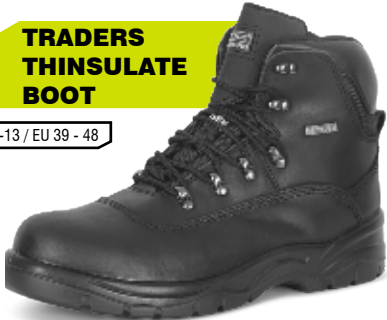

## TRADERS THINSULATE BOOT

CTF25NB UK 6 - 13 / EU 39 - 48



## COMPOSITE HIKER

CF35 UK 3 - 12 / EU 36 - 47

- EVA, TPU and Rubber
- Lightweight



beeswift.com

WORKWEAR & PPE



# FOOTWEAR



## NON-METALLIC TRAINERS

CF29 UK 4 - 12 / EU 37 - 47



• Lightweight



## EVA RUBBER

CF26 UK 3 - 12 / EU 36 - 47



• Lightweight



## 4 D-RING CHUKKA BOOT MIDSOLE

CDDCMSBL UK 3-13 / EU 36-48



# DUAL DENSITY PU RIGGERS



## UNLINED

RBUS UK 4 - 13 / EU 37 - 48

## FUR LINED

RBLS UK 4 - 13 / EU 37 - 48



## LINED SCUFF CAP

RBLSSC UK 6 - 12 / EU 39 - 47



## PREMIUM HEEL SUPPORT

CF8 UK 6 - 13 / EU 39 - 48



# HAND PROTECTION

## PARA-ARAMID SLEEVES



GZ14 | 10 INCHES

- 100% Para-aramid liner
- Lightweight
- Maximum dexterity
- Comfort with sensitivity



GZ13 | 12 INCHES

EN 388: 2016+A1: 2018 // 1.X.2.3.B



GZ15 | 18 INCHES

EN ISO 11612: 2015 // A1 F2



GZ16 | 22 INCHES



- Premium grey split leather
- Heavyweight cotton backing and safety cuff
- Para-aramid lining

EN 388: 2016+A1: 2018 // 4.X.4.4.E



## CUT RESISTANT RIGGER GLOVE

GZ70 | M(8) - XXL (11)



- 100% PU coating
- Ventilated back
- Lightweight
- Maximum dexterity
- Comfort with sensitivity

## PU PALM COATED

GZ03 | S(7) - XXL (11)

EN 388: 2016+A1: 2018 // 4.X.4.2.C



## CANADIAN RED HIGH QUALITY RIGGER

CANCHQPN | ONE SIZE - XL (10)

- Grey split leather
- Heavyweight red cotton backing and safety cuff
- Vein patch
- Good fitting large size with fleecy lined palm and thumb-face for added comfort



EN 388: 2016+A1: 2018 // 4.X.4.4.A



- Chrome leather palm
- Chrome leather thumb & first finger
- Cotton drill back
- Chrome leather knuckle strip
- Rubberized cuff
- Lined palm & fingers

## HIGH QUALITY CHROME RIGGER

CANCHQN | ONE SIZE - XL (10)

CE MINIMAL RISK

## CAT II BLUE / GOLD WELDERS GAUNTLET

BFHQWN | ONE SIZE - XL (10)

- 16" shoulder split leather
- Fully lined
- Gold leather welts
- Leather reinforced thumb and part palm
- Reinforced stitching



EN 388: 2016+A1: 2018 // 4.X.4.4.C

EN 407 // 4.3.3.X.4.X

EN 12477 Type A



- Fully coated PVC glove
- Stockinette liner
- Elasticated cuff

## PVC FULLY COATED KNITWRST GLOVES

PVCFCKWNR | S (7) - XL (10)

EN 388: 2016+A1: 2018 // 3.X.1.1.A

## QUALITY LINED DRIVERS GLOVES

FGIMP | ONE SIZE - XL (10)

- Soft grain leather
- Gun pattern design
- Half elastication to back of cuff
- Fleece lined
- Colour co-ordinated sized cuffs
- L - Green Cuff
- XL - Blue Cuff



EN 388: 2016+A1: 2018 // 3.X.4.4.B

beeswift.com

WORKWEAR & PPE

## HAND PROTECTION



### NITRILE FOAM POLYESTER

EC6NGY S (7) - XL (10)

- 100% nylon seamless shell with nitrile coated palm and fingers
- Ventilated back
- Lightweight for maximum dexterity and comfort with sensitivity

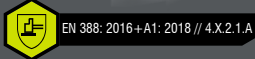

### NITRILE FOAM NYLON GLOVE

NFNG M (8) - XXL (11)

- 100% nylon seamless shell with nitrile coated palm and fingers
- Ventilated back
- Lightweight for maximum dexterity and comfort with sensitivity
- Ideal for dry or slightly oily applications

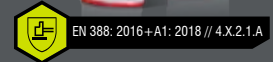

### NITRILE P/C POLYESTER

EC7NGY S (7) - XL (10)

- 100% nylon seamless shell with nitrile coated palm and fingers
- Ventilated back
- Lightweight for maximum dexterity and comfort with sensitivity
- Ideal for dry or slightly oily applications

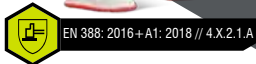

“SUITABLE FOR GENERAL ASSEMBLY HANDLING AND ENGINEERING APPLICATIONS”



### NITE STAR DIPPED GLOVES

NSGBL S (7) - XL (10)

- 100% Nylon seamless shell
- Nitrile coated palm and fingers
- Ventilated back
- Lightweight for maximum dexterity and comfort with sensitivity

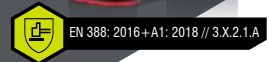

### ECONOMY GRIP GLOVES

EC8N M (8) - XL (10)

- Economy multi-purpose glove
- Natural rubber coated palm
- Knitted area on back of glove aids breathability and comfort

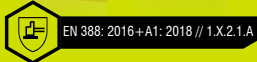

### MULTI-PURPOSE LATEX GLOVES

MP1 M (8) - XXL (11)

- Multi-purpose glove
- Latex rubber coated palm
- Knitted base construction to allow air passage and aid comfort

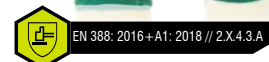

### PU COATED GLOVE

EC9NBL M (8) - XXL (11)

- Polyester glove
- Polyurethane palm coated
- Machine knitted
- Integrated elasticated wrist

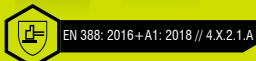

### PU COATED "PUGGY" GLOVES

PUG S (7) - XXL (11)

- Nylon glove
- Polyurethane palm coated
- Machine knitted
- Integral elasticated wrist
- Ideal for handling light components

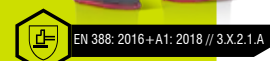



UK PPE MANUFACTURER  
FOR OVER 25 YEARS

# Leading the way in Personal Protective Equipment

We have a range of PPE ideal for  
your workers in industry



Scan QR code  
with phone camera  
to view catalogue online



ENHA



ALPHA  
SOLWAY

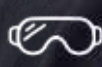

Riley®



SKYTEC



HAIKA



SHOWA





**NATIONAL POWER  
LOCAL STRENGTH**



“IADA is the UK’s largest group of independent distributors and stockists of all MRO products and associated services across every industrial sector. The Independent Authorised Distributor Alliance currently comprises of 26 independent MRO distributors that offer a first class integrated service throughout the whole of the UK. IADA’s and its members offer exceptional levels of service from experienced and knowledgeable personnel. Members also have large stock availability in towns, cities and major industrial areas across the UK and all IADA services centres provide 24/7 support. IADA and its members offer a service that is simply unrivalled.

Combined, IADA has in excess of £20m of inventory held locally across the UK with direct access to over 500 manufacturers and suppliers of world leading brands making IADA the number one choice for service and support.

The knowledge, expertise, technical support and ability to provide solutions is what customers can depend on.”

**Email:** [admin@iadaltd.co.uk](mailto:admin@iadaltd.co.uk)



**Unit 12 Manor Park  
35 Willis Way, Poole, Dorset, BH15 3SZ  
Tel: 01202 746031  
sales@ashleypower.co.uk  
www.ashleypower.co.uk**



TRADING AS ASHLEY POWER LTD